

**Technical Assessment:
Cryo-Compressed Hydrogen Storage
for Vehicular Applications**



October 30, 2006*

U.S. Department of Energy Hydrogen Program

*Revised June, 2008

Table of Contents

Introduction	3
Summary and Conclusions	7
References	8
APPENDIX A: Review of Cryo-Compressed Hydrogen Storage Systems	9
APPENDIX B: Cryo-Tank Design Elements for H ₂ Storage	18
APPENDIX C: Presentation to the FreedomCAR & Fuel Hydrogen Storage Technical Team	23
APPENDIX D: Independent Review of Cryo-Compressed Hydrogen Storage Systems	34
APPENDIX E: TIAX Cost Analysis: Cryo-compressed On-Board Cost Progress Report.....	35
APPENDIX F: Summary of BMW Comments on Cryo-Compressed Hydrogen Storage Concept	44
APPENDIX G: Summary of DOE Systems Integrator Input	47

Technical Assessment: Cryo-Compressed Hydrogen Storage for Vehicular

Applications

Introduction

The DOE Hydrogen Program conducted a technical assessment of cryo-compressed hydrogen storage for vehicular applications during 2006-2008, consistent with the Program's Multiyear Research, Development and Demonstration Plan. The term "cryo-compressed" was coined by Salvador Aceves, et al at Lawrence Livermore National Laboratory (LLNL) and refers to their concept of storing hydrogen at cryogenic temperatures but within a pressure capable vessel, in contrast to current liquid (or cryogenic) vessels which store hydrogen at low pressures. Cryo-compressed hydrogen storage can include liquid hydrogen or cold compressed hydrogen. This assessment was based primarily on LLNL's design and fabrication of a cryogenic capable insulated pressure vessel (up to 350 bar) for on-board hydrogen storage applications. The assessment included an independent review of the technical performance by Argonne National Laboratory (ANL),^{1,2,3,4} an independent cost analysis by TIAX LLC,⁵ comments received from BMW and the FreedomCAR & Fuel Partnership Hydrogen Storage Technical Team, input from LLNL and teleconferences among interested participants. Linde has patent describing cold storage.⁵ Information compiled by DOE's Systems Integrator was also reviewed as part of this assessment. Attached to this document are presentations by ANL and TIAX describing their analyses.

The assessment seeks to determine if the work should be continued by evaluating the following:

1. The technical progress to date on the capacity for hydrogen storage in cryogenic-capable, insulated pressure vessels (LLNL cryo-compressed concept) and a comparison of the status of cryo-compressed tanks with other hydrogen storage concepts under development.
2. The potential for the technology to meet the DOE 2007, 2010 and 2015 onboard storage system targets.
3. Estimates of the cost of cryogenic-capable, insulated pressure vessels and the energy consumption, both on-board and off-board.

A brief discussion of these 3 items follows:

1) Technical Progress to date

Overall technical progress has been successfully demonstrated. ANL independently assessed the current LLNL design (2nd generation) and verified that it meets the 2007 gravimetric target, but that the volumetric capacity was slightly less than the 2007 volumetric goal. Values are shown in Table 1. As seen in Figure 1, the projected storage capacity for cryo-compressed hydrogen tanks exceeds that for the current state-of-the-art materials-based hydrogen storage systems.

LLNL's 2nd generation design of an insulated high pressure tank has been built and installed on a hydrogen-fueled ICE/battery hybrid vehicle (a modified Toyota Prius). Tests are currently in progress and the final report will be available in 2008. Although improved from the earlier proof-of-concept tank, the current design, based on budget to date, is by no means optimized for

weight, volume and thermal insulation (which affect both dormancy and boil off performance). One of the key advantages of the cryo-compressed approach is that the boil off that is typical from a liquid hydrogen tank can be greatly reduced because higher pressures may be attained before the vent valve is activated. A greater understanding of actual heat leak rates and measured dormancy will also be gained through the planned testing at LLNL in 2008.

Table 1
Storage System Capacity Targets vs. Cryo-compressed Tank System

	Cryo-Compressed Tank System *			DOE 2007 Targets	DOE 2010 Targets
	LLNL	ANL	TIAX		
System gravimetric capacity (wt. %)	5.4	5.4	5.5	4.5	6
System volumetric capacity (g H ₂ /liter)	31.2	31.2	33.0	36	45

*Additional estimates show that if hydrogen is not burned to achieve the 0.02 (g/s)/kW flow rate target, the capacities could be as high as 5.7 to 5.9 wt. % and 33 to 35 g H₂/liter.^{6,7}

Figure 1: Status of current technologies relative to key system performance & cost targets

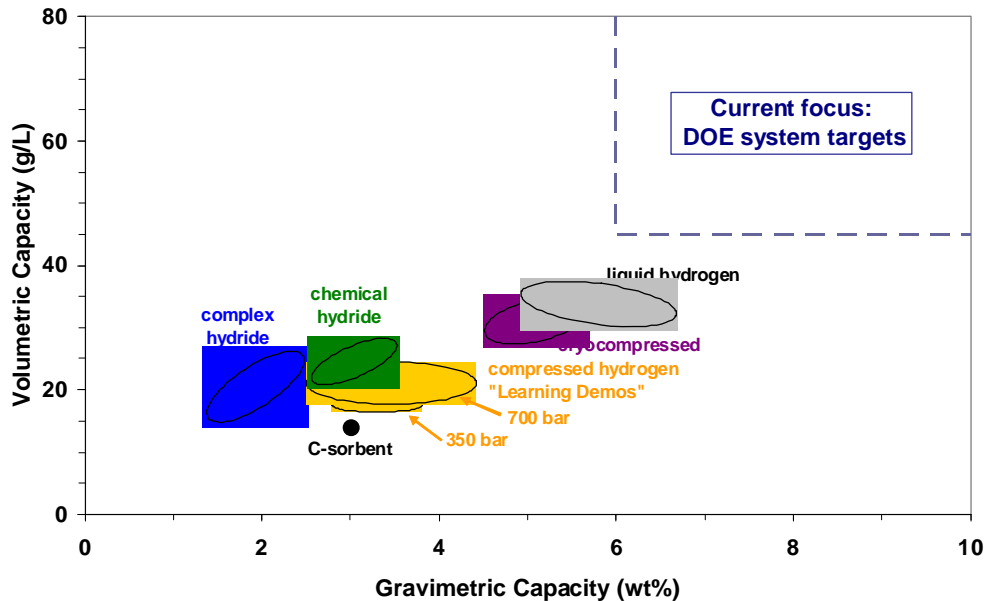

Figure 1 shows the capacity of cryo-compressed tanks reported in Table 1 compared to the current state of the art for other hydrogen storage options. Note that the values in Figure 1 represent a snapshot in time and are periodically assessed and updated by DOE (see: http://www1.eere.energy.gov/hydrogenandfuelcells/storage/tech_status.html).

Values represent analysis results or projections for full system capacities based on R&D results for various technologies and specific system designs available in or prior to 2006. The range of values reported as “tanks (Learning Demo)” represent actual full system data as reported from 92 vehicles validated through DOE’s Technology Validation Program.

2) Potential for achieving onboard storage targets

ANL performed a sensitivity analysis to examine potential design changes for improving the capacity of the LLNL 2nd generation design. Their analysis concluded that a thinner thermal barrier would yield a slight volumetric improvement – from 30 g H₂/liter to about 33 g H₂/liter – approaching the 2007 target, but below the 2010 volume target. They conclude that “radical changes” would be needed to achieve the 2010 volumetric capacity target. With a lighter Al shell, they estimate a weight density of 6.7 to 6.9 wt. %, just above the 2010 target. In summary, the consensus opinion from experts at ANL and others is that both 2007 capacity targets may be achievable. Based on today’s technology, the 2015 volumetric target, however, is beyond the reach of current cryo-compressed tank designs and operational conditions.

3) Cost and Energy Estimates

TIAX performed an independent cost analysis of an on-board hydrogen storage system based on a cryogenic-capable, insulated pressure vessel that can achieve a maximum design pressure of 350 bar and hold a maximum of 10.1 kg of usable liquid hydrogen (10.7 kg total design capacity based on ANL calculations of 94% usable capacity).⁶ The system design used for the TIAX cost analysis was slightly different from the ANL design, but the key components were the same. Differences included removing the in-tank heater and adding a return loop from the ex-tank heat exchanger to add heat to the tank when required. This concept was derived from BMW’s cryogenic tank pressure control concept. This return loop also requires additional control valves. They also added a third tube passing into the tank for extracting liquid hydrogen. This third tube accompanies the existing tube used for extracting vapor and a tube used for filling. The heat exchanger return loop is also tied into the fill tube. They included three relief valves in their cost analysis, two on the vapor extraction line, and one on the liquid extraction line. As a result of BMW’s feedback on automotive requirements, they also included a fill pipe and valve box that are both cryogenically insulated, and costed the cryogenic control valves as electronically controlled valves, as opposed to the manual control valves specified in the LLNL design.

The TIAX cost analysis assumes high volume manufacturing at the level of 500,000 units per year, consistent with prior on-board hydrogen storage and fuel cell system cost analyses conducted for the Hydrogen Program that assume “automotive scale” production volumes. TIAX obtained feedback from key cryogenic and high-pressure tank developers, held discussions with cryogenic and high-pressure component vendors, and reviewed patent literature to update the system design and cost models to update their earlier cryo-compressed cost estimates. Their latest results indicate that the manufactured cost of a complete cryo-compressed system would be approximately \$14/kWh of usable energy capacity assuming 10.1 kg usable liquid hydrogen.⁷ The two main cost contributors are the carbon fiber composite and the group of cryogenic valves and regulator, each accounting for about 30% of the total system cost.

The cost estimate for cryo compressed tanks exceeds the 2007 target of \$6/kWh, but is less than the cost estimates for complex hydride and compressed hydrogen tanks (350 and 700 bar).⁸ BMW reviewed the latest cryo-compressed cost analysis and, based on their liquid hydrogen tank experience, and on their preliminary cost estimate for a cryo-compressed hydrogen vehicle storage system, concluded that the TIAX cost estimate is within the range of expected values. According to the sensitivity analysis performed by TIAX,⁹ the range of uncertainty for the tank's carbon fiber cost and safety factor assumptions, as well as the control valve cost uncertainty, have the biggest impact on the overall cost estimate (roughly 5-10% each). Sensitivity analysis for the tank manufacturing assumptions (i.e., assumed assembly and processing times) resulted in less than 2% impact on overall cost for each individual processing step evaluated.

ANL examined the storage capacity of a cryo-compressed tank and the associated issue of energy requirements for refueling it. The cryogenic approach allows considerable flexibility in how to fill the tank and use it; for example, as a low pressure liquid hydrogen tank, a high pressure liquid hydrogen tank, a compressed gas tank at cryogenic or ambient temperatures and combinations of these options. The storage capacity is the smallest, 3.5 kg, if the tank is refueled with compressed hydrogen at 350 bar and ambient temperature. In this case, the energy consumed in storing hydrogen corresponds to the electric energy required to compress it. This amounts to 2.0 kWh/kg-H₂,¹⁰ assuming that hydrogen is compressed off-board to 125% of the storage pressure, or 6 % of the lower heating value of hydrogen. The storage capacity is the highest, 10.7 kg, if the tank is refueled with liquid hydrogen and the initial tank temperature is less than 180 K. In this case, the energy consumed in storing hydrogen corresponds to the electric energy needed to liquefy it at the central plant plus the electric energy needed to pump it at the refueling station. This amounts to 8 kWh/kg-H₂,¹¹ assuming a liquefaction plant of 200-tpd capacity, or 24% of the lower heating value of hydrogen.

The cryo-tank will contain between 6.2 kg and 10.7 kg of hydrogen if the tank is refueled with subcritical liquid hydrogen, and the initial tank (liner and carbon fiber) temperature is between 180 K and 300 K. In this case, hydrogen is stored not in a liquid state but depending on the initial temperature, as compressed cryo-gas or a two-phase mixture of liquid and gaseous hydrogen. Regardless of the initial tank temperature, 10.7 kg of liquid hydrogen can always be stored if the tank is equipped with a vent valve and refueled using a "feed and bleed" procedure. In this case, more than 10.7 kg of liquid hydrogen must be fed to the tank; the amount in excess of 10.7 kg boils off to cool the tank to 180 K. The amount that boils off and discharges through the vent valve to be collected in an off-board reservoir depends on the initial tank temperature: >10.7 kg at 300-K initial temperature, 5.4 kg at 200-K initial temperature, and zero at <180-K initial temperature. More than 10.7 kg could be stored by filling with supercritical hydrogen (e.g. 130 bar-300 bar and 30K-45K). Cryo compressed hydrogen at 250 bar and 35K, has a density of 80 g/L and results in 12 kg or 12% more hydrogen than the baseline system.

Summary and Conclusions

This assessment concludes that cryo-compressed tank research and development should continue, with the assumption that current testing onboard a vehicle provides the expected performance and does not uncover any significant issues. The volumetric system capacity was found to have an average of 32 g/L, higher than other storage options studied to date and equal to estimates for liquid hydrogen systems. The gravimetric capacity is 5.4 wt. %. Previous estimates were 4.7 wt. % and 30 g/L.⁶ The cryo-compressed system has several advantages over liquid hydrogen systems: a dormancy advantage, the option to fill with ambient temperature hydrogen for reduced travel requirements, potentially lower fueling station costs, and a simpler method for monitoring hydrogen in the tank. The cost was estimated to be approximately \$14/kWh according to TIAX. This cost is approximately 50% less than current 700 bar and 20 % less than current 350 bar system assessments respectively.⁸ The cryo-compressed system has approximately twice the volumetric efficiency of 350 bar systems and has a 40% higher volumetric efficiency than 700 bar systems. These advantages come at the cost of increased off-board energy consumption due to liquefaction energy requirements.

The cryo-compressed approach developed through DOE Hydrogen Program funding has reached a certain level of maturity and significant cost-share should be expected from industry for future work. Collaboration between LLNL and auto industry partners to ensure that next generation designs are optimal for hydrogen-powered vehicles is essential for the successful “hand off” of government-funded R&D to industry and ultimate successful commercialization. In addition, further input from the energy companies responsible for developing hydrogen refueling stations is required. The testing planned under DOE’s Technology Validation effort during 2008 will provide a better assessment of any remaining challenges with this technology. A greater understanding of actual heat leak rates, a point of concern raised by DOE’s Systems Integrator, will also be gained through the planned testing at LLNL in 2008.

The technology appears to exceed the capacity of current chemical hydride systems, with the added benefit of bypassing material regeneration issues, and is well ahead of current reversible metal hydride system capacities. Note that the numbers presented by TIAX and ANL are based on the density of liquid hydrogen (71g/L) at atmospheric pressure. The density may actually be 5% to 20% higher when considering supercritical high-pressure, cold gas.¹² Further engineering developments, although challenging, should be achievable. Both weight and volume improvements may be possible through optimizing insulation and fill temperatures and pressures. These design changes need to be balanced with dormancy and boil-off requirements. BMW is assessing driving scenarios to determine the reduction in insulation that can be realistically achieved. Future DOE funding will focus on novel concepts that have potential for meeting long term targets. This includes cryo-compressed tank concepts that allow the use of materials based technologies and/or conformable tank designs to help achieve long term targets.

References

1. Cryo-Compressed Storage Independent Review: Scope and Schedule, Dr. Rajesh Ahluwalia, Argonne National Laboratory, June, 2006 (Attached as Appendix A)
2. Review of Cryo-Compressed Hydrogen Storage Systems by Argonne National Laboratory, R. K. Ahluwalia, V. J. Novick, and J.-K. Peng, October, 2006 (Attached as Appendix A)
3. Cryo-Tank Design Elements for HYDROGEN Storage, V. J. Novick, Argonne National Laboratory, September, 2006 (Attached as Appendix B)
4. Independent Review of Cryo-Compressed Storage of Hydrogen: Interim Report, R.K. Ahluwalia, V. J. Novick and J-K Peng, Argonne National Laboratory, Hydrogen Storage Tech Team Meeting, Southfield, MI, August 17, 2006 (Attached as Appendix C)
5. United States Patent, US 6,983,611 B2, Storage Container for Cryogenic Media, January 10, 2006
6. System Level Analysis of Hydrogen Storage Options, DOE Annual Progress Report 2007; by Rajesh K. Ahluwalia, Argonne National Laboratory
http://www.hydrogen.energy.gov/pdfs/progress07/iv_f_1_ahluwalia.pdf
7. Analyses of Hydrogen Storage Materials and On-Board Systems, DOE Merit Review Presentation; by TIAX, S. Lasher, K. McKenney, Y. Yang, June, 2008
http://www.hydrogen.energy.gov/pdfs/review08/st_1_lasher.pdf (Attached Appendix E)
8. Analyses of Hydrogen Storage Materials and On-Board Systems, DOE Merit Review Presentation; by TIAX, S. Lasher, K. McKenney, Y. Yang, June, 2008
http://www.hydrogen.energy.gov/pdfs/review08/st_1_lasher.pdf (Attached Appendix E)
These other cost estimates were for smaller hydrogen storage capacities (i.e., 5.6 kg usable hydrogen), which will tend to make them somewhat more expensive on a \$/kWh basis.
9. Analyses of Hydrogen Storage Materials and On-Board Systems, DOE Merit Review Presentation; by TIAX, S. Lasher, K. McKenney, Y. Yang, June, 2008
http://www.hydrogen.energy.gov/pdfs/review08/st_1_lasher.pdf (Attached Appendix E)
10. “Fuel Cycle Efficiencies of Different Automotive On-Board Hydrogen Storage Options,” Int. J. Hydrogen Energy (2007), R. K. Ahluwalia, T. Q. Hua and J. K. Peng, doi: 03.021
11. “Liquefaction and Pipeline Costs,” Hydrogen Delivery Analysis Meeting, B. Kelly, Columbia, MD, May 8-9, 2007
12. Tobias Brunner, personal communications and T. Brunner, J. Lutz, presentation at National Hydrogen Association Conference, San Antonio, TX, 2007
Updated: “One for All, and All for One? – Automotive Hydrogen Storage Portfolio and Best-fit Application”, T. Brunner, O. Kircher, NHA Sacramento, CA, 2008 Paper#3952

APPENDIX A: Review of Cryo-Compressed Hydrogen Storage Systems

by

Argonne National Laboratory

R. K. Ahluwalia, V. J. Novick, and J.-K. Peng

(Revision 2, February 19, 2006)

Introduction

Argonne National Laboratory has conducted a review of the cryo-compressed hydrogen storage concept and prototype proposed and developed by Lawrence Livermore National Laboratory (LLNL) and Structural Composite Industries. In this concept, hydrogen is stored in an insulated pressure vessel that is capable of operating at cryogenic temperature. The vessel itself is not designed to cool or liquefy the supplied hydrogen; rather, it can be filled with liquid or compressed hydrogen at low temperatures. Argonne worked closely with LLNL to define the prototype system in detail and analyzed the system for its hydrogen storage capacity as well as dynamic performance during the charging and discharging of hydrogen to/from the storage vessel. These characteristics were analyzed with respect to the 2007 and 2010 DOE targets for automotive hydrogen storage systems.

Objective and Scope

The objective of this review and analysis was to assess the gravimetric and volumetric hydrogen storage capacity of the cryogenic-capable, insulated pressure vessel concept and prototype developed by LLNL, and to determine the operational performance of this cryo-tank technology and the benefits of potential improvements in this technology.

The Argonne analysis required that the specified minimum delivery pressure (8 bar in the 2007 target tables) and minimum full flow rate (0.02 (g/s)/kW for an 80-kW fuel cell power system) be met at all times, regardless of the “state-of-charge” of the cryo-tank.

Items not included in the Argonne review were the costs of the storage system or the costs of the hydrogen fuel. Argonne has worked closely with TIAX in the latter’s assessment of these costs.

Schedule

The schedule for the Argonne review and analysis is summarized in Table 1.

Table 1. Schedule for the review of the LLNL cryo-compressed hydrogen storage tank concept by Argonne

Activity	Schedule
Data Collection	April 1 – May 30, 2006
Data Analysis	June 1 – July 15, 2006
Compile Review Results	August 1, 2006
Draft Presentation to and Discussion with Stakeholders and DOE	August 17, 2006
Draft Report Submitted to NREL	September 15, 2006

Review of the Lawrence Livermore National Laboratory Design Data

A schematic of the LLNL cryo-tank design is shown in Fig. 1. Details of this design compiled by Argonne are given in Appendix A. The pressure vessel consists of an aluminum liner wrapped with carbon fiber composite winding, surrounded by superinsulation and a stainless steel vacuum jacket. Other in-tank equipment includes tubing for fill and vent lines and pressure sensing, thermocouples for temperature monitoring, and an electric heater to maintain the desired gas pressure in the tank.

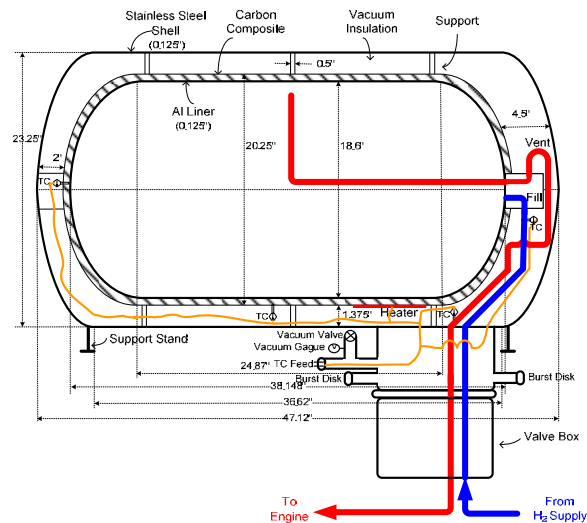

Fig. 1. Design schematic of the LLNL cryo-tank.

The ex-vessel components in the LLNL cryo-tank are shown schematically in Fig. 2. These components include various valves (pressure relief, fill, vent, and vacuum, enclosed in a valve box), piping and tubing, rupture disks, connection ports, pressure and vacuum gauges, pressure regulator, heat exchanger, tank frame and support structure, and wiring and electronics boards. For purposes of weight and volume determination, the flow controller and shut-off valve are not considered to be parts of the hydrogen storage system, rather parts of the fuel cell or engine. Inclusion of these components would add less than 1% penalty to the weight and volume.

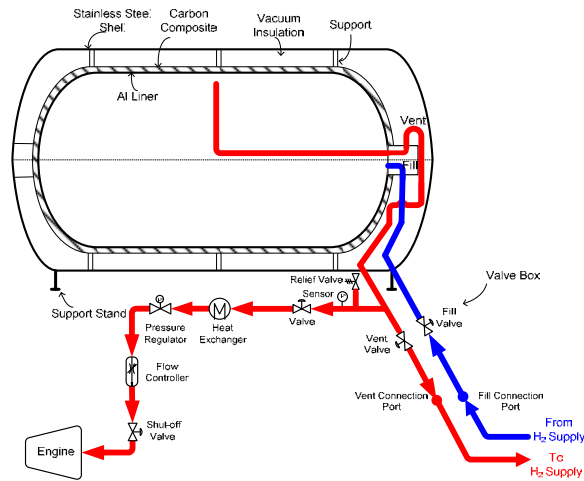

Fig. 2. Design schematic of the ex-vessel components in the LLNL cryo-tank.

For the LLNL cryo-compressed hydrogen storage system, the total system volume is calculated to be 323 L providing a storage volume of 151 L of hydrogen, corresponding to a “volumetric efficiency” of 47%. Of the total volume, the vessel volume is 297 L, while the ex-vessel components add another 26 L. The total system weight is 187 kg, not including 10.7 kg of hydrogen stored as a liquid or 3.5 kg of hydrogen stored as compressed gas. The vessel weighs 155 kg and the ex-vessel components weigh 32 kg. Breakdown of these weights and volumes by sub-component is shown by the pie charts in Fig. 3.

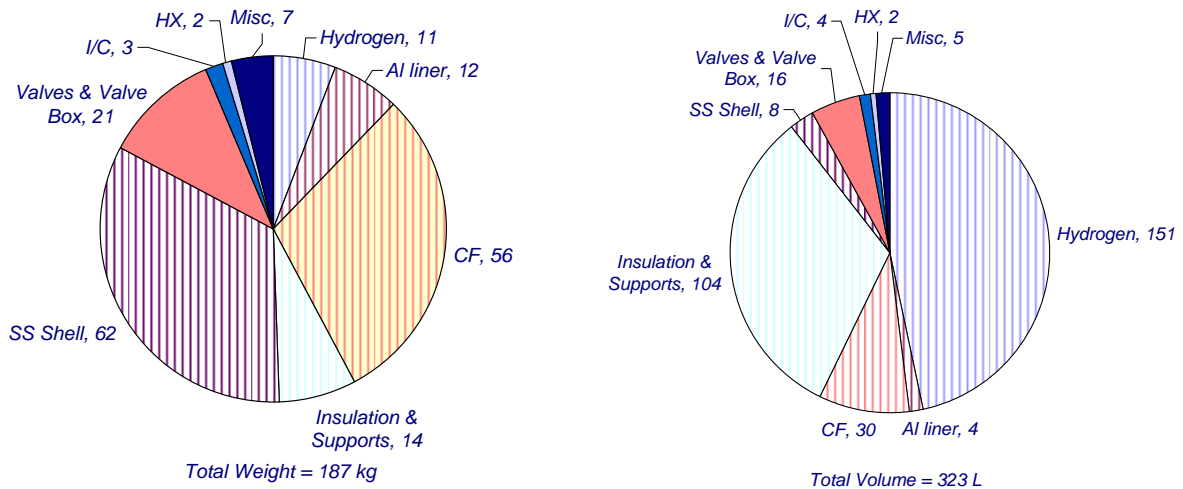

Fig. 3. Weight and volume breakdown by sub-component in the LLNL cryo-tank.

For this system design, therefore, the volumetric hydrogen storage capacity (but not necessarily the *recoverable* hydrogen storage capacity) translates to 33.1 kg/m³ or 1.1 kWh/L (based on the lower heating value of hydrogen). The density of liquid hydrogen is 71.1 kg/m³, while that of compressed hydrogen is 23.2 kg/m³. This storage system’s gravimetric capacity is 5.7 wt. % of hydrogen, corresponding to 1.9 kWh/kg.

Figure 4 shows the LLNL cryo-tank with some modifications and additions to facilitate fill and operation in different modes. These modifications include the addition of an in-tank electric

heater, a level indicator, moving the fill and vent valves inside the shell (with the actuators being outside the shell), and a larger capacity heat exchanger, where the needed heat is provided by the coolant from the fuel cell stack. The additional weights and volumes because of these modifications are not included in Fig. 3 results. It is estimated that inclusion of these components would add less than 2% to at most about 5% in terms of a weight and volume penalty.

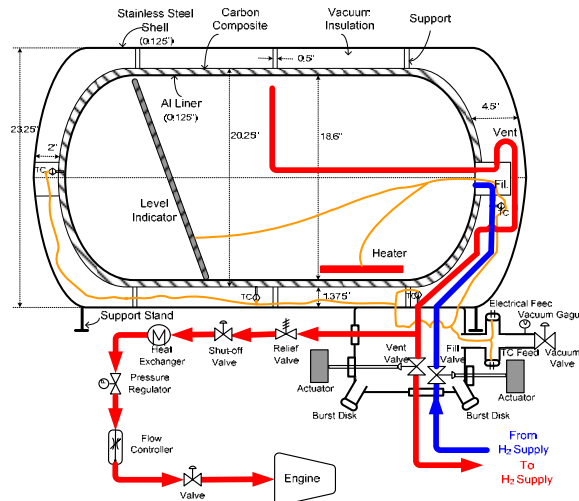

Fig. 4. Modified cryo-tank.

System Performance Analysis by Argonne National Laboratory

The operating performance of the LLNL cryo-tank concept was analyzed by Argonne and the results are summarized below. The major thrust of this analysis was to assess system performance and energy requirements for various filling and operating scenarios. For this purpose, Argonne developed a transient model for filling, discharging, and dormancy for refueling with liquid hydrogen as well as cryogenic compressed gaseous hydrogen. The fill rates (10 min and 3 min), discharge rates (0.02 (g/s)/kW and 0.02 (g/s)/kW), and delivery pressure (8 bar and 4 bar) were taken from the hydrogen storage systems targets for 2007 and 2010, respectively. For conditions where the tank pressure is lower than the minimum required delivery pressure, the in-tank electric heater was used to raise the pressure to the required value. The limit on dormancy was based on a 425-bar set-point for the pressure relief valve. The Benedict-Webb-Rubin equation-of-state was used for hydrogen in this analysis.

This analysis and its results were discussed with the FreedomCAR and Fuel's Hydrogen Storage Technical Team on August 17, 2006. The set of slides used in that discussion is shown in Appendix C; some of those slides are referred to in the summary below and Appendix B should be referred to for additional details.

Refueling and Operation: Charging, Discharging, Dormancy

To enable use of liquid hydrogen in the cryo-tank concept, the liquid interface includes separate fill and vent lines (the vent is not to the atmosphere but back to the filling station hydrogen capture system). For filling such a tank with liquid hydrogen, two different filling options were analyzed:

1. In the high-pressure fill option, the liquid hydrogen is supplied by the off-board system at 350 bar through the fill line. The displaced gaseous hydrogen is vented only at 350 bar through the vent line. The model shows that the charging dynamics depend on the initial state of the hydrogen in the tank.
2. In the low-pressure fill option, liquid hydrogen at near-ambient pressure is pumped into the tank through the fill line and the displaced gaseous hydrogen is vented at the low pressure. After the tank is filled to 100% of rated capacity, the liquid hydrogen is heated by the tank heater to the minimum required delivery pressure (8 bar for 2007 for fuel cell power systems).

High-Pressure Liquid Hydrogen Refueling

Storage dynamics for the high-pressure liquid hydrogen refueling option depend on the initial conditions of the storage vessel.

Case 1: Initial tank temperature is 300 K

At the start of the filling operation, the storage tank is at 300 K and 8 bar (fully depleted and warmed up to room temperature, Slide 10, Appendix C). Liquid hydrogen is supplied at 350 bar. As the hydrogen is added to the tank, the pressure in the tank increases, and the tank temperature decreases, until approximately 6.2 kg of hydrogen has been added. At this time, the pressure in the tank reaches 350 bar, and the temperature is 150 K. As additional liquid hydrogen is added, gaseous hydrogen is vented from the tank (recovered by the off-board fueling facility) and the temperature continues decreasing. By the time 10.7 kg of hydrogen is stored in the vessel as a cryo-compressed gas at 350 bar and 63 K, a total of 24.1 kg of liquid hydrogen have been charged into the tank.

If <6.2 kg of hydrogen are stored in the tank, no venting is needed during the refueling operation.

Case 2: Initial tank temperature is 50 K

At the start of the filling operation, the storage tank is at 50 K and 8 bar (fully depleted but at low temperature, Slide 11, Appendix C). Liquid hydrogen is supplied at 350 bar. As the first kilogram of hydrogen is added to the tank, the state of hydrogen stored in the tank is as superheated gas and its pressure and temperature decrease to 5 bar and 27 K, respectively. As the next 9 kg of hydrogen are added, the pressure and the temperature continue to decrease gradually to 3 bar and 24 K, respectively, as the stored hydrogen is a saturated liquid-gas mixture. With the addition of the last 0.7 kg of hydrogen, the pressure increases to 58 bar and the temperature rises to 27 K.

In this scenario, storing 10.7 kg in the cryo-tank requires a charge of 10.7 kg of hydrogen as no fuel is vented, because the highest pressure reached is less than 350 bar.

Other Scenarios: Initial tank temperature ranging from 30 to 300 K

For various other initial conditions of the tank, the hydrogen at the end of the filling operation will be either a compressed gas or a liquid, and different amounts of hydrogen will need to be vented to store the 10.7 kg of hydrogen. For an initial pressure of 8 bar, if the initial temperature is between 30 and 100 K, the final state of the hydrogen will be liquid at pressures between 58 and 95 bar. If the initial temperature is between 120 and 180 K, the final state of the hydrogen will be as cryo-compressed gas at temperatures up to 63 K and pressures up to 350 bar. Up to initial temperatures of <180 K, no hydrogen will need to be vented and the charged and stored hydrogen will each equal 10.7 kg. At initial temperatures >180 K, the amounts of hydrogen that can be stored without venting any gas decrease from 10.7 kg at 180 K to 6.2 kg at 300 K (see Slide 12, Appendix C).

Low-Pressure Liquid Hydrogen Refueling

For refueling with low-pressure liquid hydrogen, first the initial tank pressure of 8 bar will have to be vented down to the pressure of the liquid hydrogen feed. For an initial tank temperature of 300 K, 2.2 kg of liquid hydrogen will be needed to reduce the tank temperature to 20.3 K, the boiling point of liquid hydrogen; the vaporized hydrogen will need to be vented. Only after that, will the charged hydrogen stay in the tank as liquid hydrogen.

This initial hydrogen boil off is a measure of the liquefaction energy of hydrogen that is consumed in cooling the cryo-tank from its temperature at the start of the fueling operation to 20.3 K. This energy penalty ranges from 22% at 300 K initial tank temperature to a little over 1% at an initial tank temperature of 30 K. Note that in all of these analyses, it was assumed that at the beginning of the fueling operation, the tank pressure is 8 bar, which is vented down to 1 bar before the fill with liquid hydrogen is initiated.

Hydrogen Discharge Dynamics

Low-Pressure Liquid Hydrogen Storage (Slide 13, Appendix C)

In this option, the cryo-tank is filled at atmospheric pressure (1 bar). Since the minimum delivery pressure is 8 bar, the maximum desired discharge rate of 1.6 g/s (for an 80-kW fuel cell system) from a full tank requires a heat input of close to 1 kW. At this time, and until 2.5 kg of hydrogen have been removed from storage, the hydrogen exists as a sub-cooled liquid. During the removal of the first 2.5 kg of hydrogen, the heat input requirement decreases linearly to 0.6 kW and the temperature increases gradually to the saturation temperature of 30 K. As the hydrogen discharge continues from the tank, the hydrogen exists as a saturated liquid-gas mixture until the amount of hydrogen left in the tank drops to 1.6 kg. At a hydrogen inventory of less than 1.6 kg, additional heating is required to provide superheated gas; the input heat requirement increases rapidly as the hydrogen is depleted, reaching more than 1 kW as the stored hydrogen amount decreases below about 0.5 kg. In this scenario, the ultimate amount of

recoverable hydrogen (at the desired full flow rate of 1.6 g/s) depends on the heater's power rating.

Medium-Pressure Liquid Hydrogen Storage (Slide 14, Appendix C)

If the initial hydrogen discharge conditions are 58 bar at 27 K (see Case 2, above, for high-pressure liquid hydrogen refueling), no heat input is required for the removal of the first 0.7 kg of hydrogen. Assuming that this removal is at the full flow rate of 1.6 g/s (perhaps not a justified assumption for the automotive application), the tank temperature decreases slightly as the tank pressure decreases to 8 bar. At that point, the tank conditions are similar to those of the low-pressure discharge dynamics case discussed above.

High-Pressure Cryo-Gas Hydrogen Storage (Slide 15, Appendix C)

For discharge from a tank full of cryo-compressed gas at initial conditions of 350 bar and 63 K (state of the tank after complete filling according to Case 1, above), the tank initially cools as the hydrogen is withdrawn. The supercritical gas transforms to saturated liquid when 4.1 kg of hydrogen have been removed. As another ~1 kg of hydrogen is discharged, the tank pressure drops to 8 bar, and further withdrawals of hydrogen from the tank require 600 W of heat input to maintain the 8 bar pressure while supplying hydrogen at the full flow rate of 1.6 g/s.

Dormancy and Hydrogen Loss

Dormancy (time before any hydrogen will need to be vented) and hydrogen loss (maximum fraction of the original charge that may be lost by venting) may be expressed in terms of the cumulative heat in-leakage into the tank. A 1 Wd (Watt-day) heat in-leakage is equivalent to 86 kJ. Starting with a full tank containing 10.7 kg of hydrogen at 8 bar and 20.9 K (Slide 16, Appendix C), there will be no venting of the hydrogen until the tank pressure builds up to 425 bar (the setting on the pressure relief valve). This requires a heat input of nearly 46 Wd or 4 MJ, as a result of which the temperature of the hydrogen rises to nearly 80 K. Hydrogen then vents at an initial rate of 1.7 g/h, which rate decreases with time as the tank warms. Even if the tank warms to room temperature, there will still be 4 kg of hydrogen remaining in the tank at 425 bar pressure (i.e., there would be a maximum loss of 64% of the initial charge of hydrogen).

The dormancy and hydrogen loss were analyzed for the different types of hydrogen storage in the cryo-tank (Slide 17, Appendix C). The cases examined and their initial conditions at full charge were:

1. Cryo-compressed gas at 350 bar and 63 K
2. Medium-pressure liquid at 58 bar and 27 K
3. Low-pressure liquid at 8 bar and 20.9 K

Hydrogen stored as a low-pressure liquid offers the highest dormancy of 46 Wd (3.95 MJ), while the cryo-compressed gas offers the lowest dormancy of 10 Wd (0.85 MJ). The medium-pressure liquid hydrogen storage option offers an intermediate dormancy of 41 Wd (3.55 MJ).

Summary and Conclusions

- The LLNL cryo-tank with the high-pressure liquid hydrogen fueling option offers a *recoverable* hydrogen gravimetric capacity of 1.8 kWh/kg (5.4 wt. %), which exceeds the 2007 target of 1.5 kWh/kg (4.5 wt. %). However, this gravimetric capacity falls short of the 2010 target of 2 kWh/kg (6 wt. %).
- The cryo-tank has a *recoverable* hydrogen volumetric capacity of 1 kWh/L (0.031 kg/L), which is less than the 2007 target of 1.2 kWh/L (0.036 kg/L) or the 2010 target of 1.5 kWh/L (0.045 kg/L).
- The recoverable fraction of the total stored inventory in the cryo-tank depends on the minimum hydrogen delivery pressure and the power rating on the heater; in general, it is approximately 94% at temperatures below 50 K (the value used throughout this report, corresponding to chiefly cryogenic operation), but up to an additional 0.5kg hydrogen fuel, corresponding to 99% recoverability, would be available as the vessel warms to ambient conditions.
- The consumption of liquid hydrogen during refueling depends on the initial temperature in the tank, which, in turn, depends on the previous refueling and fuel consumption (driving) history. For initial temperatures less than 180 K, no hydrogen needs to be vented and the amount of liquid hydrogen charged into the tank equals the amount of hydrogen stored. At higher initial temperatures, the amount of liquid hydrogen charged may be as high as 2.27 kg per kilogram of hydrogen stored. (This excess liquid hydrogen represents an excess energy consumption for re-liquefying the vented hydrogen.)
- For the cases where the tank heater needs to be turned on to maintain the 8-bar minimum delivery pressure, energy input to the tank ranges from 1.75 MJ for cryo-compressed gas at 350 bar and 63 K to 3.6 MJ for liquid hydrogen at 8 bar and 31 K. This energy input includes the energy provided by in-leakage. Thus, the electrical energy requirement for complete recovery of the stored hydrogen (subject to the constraint of the maximum recoverable fraction discussed above) will be somewhat less, depending on the elapsed time over which the hydrogen is discharged.
- The effects of improvements to the cryo-tank design were also analyzed. These improvements included the tank modifications discussed above, improved (tighter) packaging, and a thinner insulation (1-in thick rather than 1.375-in thick). Even with these improvements, the 2015 targets for gravimetric and volumetric hydrogen storage capacities will not be achieved (Slide 19, Appendix C), and more radical design changes will need to be explored.
- In order to achieve the DOE 2010 target for volumetric storage capacity, the vacuum jacket volume must be reduced substantially, and the hydrogen storage volume likely increased through use of a lower pressure vessel. A 3600-psi vessel with an internal volume of 160 L, enclosed in a 235 L jacket, with 15 L of ex-vessel components would achieve this 2010 volumetric capacity goal. This would correspond to a 60% reduction in the volume of ex-vessel components, a reduction of 4 inches in vacuum jacket length (to

about 43 inches), and 2 inches in vacuum jacket diameter (to 21.25 inches). Recent heat leak testing at LLNL indicates these reductions may be feasible without undue dormancy impacts.

APPENDIX B: Cryo-Tank Design Elements for Hydrogen Storage

V. J. Novick, Argonne National Laboratory

September 2006

A hydrogen storage system designed for automotive fuel cell applications, can be divided into in-vessel and ex-vessel components. The in-vessel components described below are identical to those developed by Lawrence Livermore National Laboratory (LLNL) and Structural Composite Industries. Ex-vessel components are similar, but some effort has been made to select the lightest weight components that meet the temperature and pressure requirements of the system. Values of the LLNL systems were used if nothing lighter was found.

1. In-Vessel

1.1 Pressure Vessel

The pressure vessel is composed of an aluminum liner wrapped with a carbon composite. The aluminum liner is chosen for its low weight and excellent resistance to hydrogen permeability. The carbon composite is bonded to the exterior of the aluminum liner to increase the pressure rating of the vessel. The entire pressure vessel is rated at 5000 psig with a safety factor of 2.25. The operating temperature range is specified as -51°C (-60°F) to $+71^{\circ}\text{C}$ ($+160^{\circ}\text{F}$).

1.1.1 Aluminum Liner

- The liner is fabricated from Grade 6061-T6 aluminum, 3-mm-thick around the circumference but thicker at the rounded (but not hemispherical) ends.
- The liner is 472.4-mm (18.6") ID x 969-mm (38.15") long, with an enclosed volume (available for hydrogen storage) of 151 L.
- The calculated weight and volume of the aluminum liner are 10.64 kg and 3.94 L.
- One end is open to the fill stub, which transitions from aluminum to stainless steel, allowing for stainless steel fill fittings and tubing. The stub is estimated to have internal dimensions of 51.6 mm (2.03") ID x 51.6 mm (2.03") length, and external dimensions of 80.8 mm (3.18") OD x 90.2 mm (3.55") length. The calculated stub volume and weight are 0.27 L and 1.35 kg, respectively.

1.1.2 Carbon Composite

- The carbon composite is made up of approximately 60% carbon fibers, with the ends being thicker (32.3 mm) than the circumference (21 mm).
- The composite OD is 514.4 mm (20.25"), with an overall length of 1033.5 mm (40.69").
- The calculated weight and volume of the composite are 48.58 kg and 30.17 L, respectively.

An end fitting is attached to the stub to allow for inlet and outlet tubing connections. The end fitting measures 64.5 mm (2.54") OD x 80.8 mm (3.18") long. The calculated weight and volume of the fitting are 2.05 kg and 0.26 L, respectively. The calculated weight and volume of the entire pressure vessel are 62.62 kg (138 lbs) and 185.41 L, respectively.

Three rings fabricated from G-10 support and center the vessel on the circumference. An additional support/stand-off is installed at each end of the pressure vessel. The calculated weight and volume of the five G-10 pieces are 5.48 kg and 3.06 L, respectively.

Insulation around the pressure vessel consists of 40 layers of superinsulation, except for the G-10 supports. Two layers of superinsulation are used over the G-10 supports. This insulation is calculated to have a volume of 104 L and a mass of 6.04 kg, assuming a density of 60 kg/m^3 for the superinsulation.

1.2 Vacuum Jacket

The vacuum jacket is comprised of a 3-mm-thick, Type 304, stainless steel shell that surrounds the pressure vessel. The shell allows confinement and protection of the insulation and the instrumentation between the shell and the pressure vessel. The shell has a flanged nipple welded to its circumference, near the stub end of the pressure vessel, that allows for vessel evacuation, instrumentation feed-throughs, and the fill and vent lines.

1.2.1 Shell

- The vacuum shell is 591 mm (23.25") OD x 1196.8 mm (47.12") length.
- The enclosed volume of the vacuum shell is 300 L, including the flanged half-nipple.
- Weight, including the flanged half-nipple, is calculated to be 57.32 kg

1.2.2 Instrumentation and Equipment

- Four thermocouples monitor the temperature of the storage vessel. One is located on the metal end fitting of the pressure vessel, while the other three are on the carbon composite: one at the support opposite from the end fitting, one near the heater, and the third on the circumference of the pressure vessel.
- Two coils of tubing are provided to fill and empty the pressure vessel. Each coil is three to four feet long. The OD of the tube is 1/2", and the wall thickness is 0.065". The coils are used to increase the thermal resistance to the heat flowing from the valve box to the pressure vessel.
- A pressure sensing tube, 1/16" ID, is used to sense the hydrogen pressure in the vessel. The sensor itself is located outside the vacuum jacket. The pressure line in the vessel weighs about 5 g.
- An electric resistive heater is mounted to the pressure vessel. The mass and volume are unknown but the weight is included in the pressure vessel weight. The heater is needed for long distance driving. For short range driving, the heat gained by the hydrogen from the cryo-tank surroundings is sufficient to vaporize the required hydrogen gas needed for the engine. This ambient heat transfer is insufficient for extended driving, however, and must be supplemented by the electric heater to provide sufficient hydrogen gas to the engine.

The weight of the assembled vacuum jacket with the installed pressure vessel was measured by LLNL to be 144 kg. The sum of the weights calculated above is 151 kg. The difference is likely due to the 5.5 kg mass of the 10-in flange that seals the half-nipple, since all of the intermediate weights are in close agreement (i.e., within <1 kg). The volume of the assembly is given by

LLNL as 297 L, compared to the calculated volume of 300 L. Again, the difference appears to be the inclusion of the half-nipple in the calculated volume.

2. Ex-Vessel

There is a variety of ancillary equipment and instrumentation outside the hydrogen storage vessel. This equipment is needed to facilitate monitoring and transfer of hydrogen to and from the storage vessel.

2.1 Computer

The hydrogen storage vessel computer is a microprocessor add-on to the vehicle's on-board computer. This computer monitors and controls various electronic components needed to measure and record system pressures and temperatures. It can also be used to calculate the quantity of hydrogen in the vessel and control the addition of heat by the electric heater when needed. The mass of this computer is estimated by LLNL to be 0.2 kg.

2.2 Electronic Boards

These boards are needed to interface the sensors to the computer. These are estimated to weigh 9 kg by LLNL.

2.3 Valves

- Fill Valve – valve used in hydrogen filling operations. For high energy efficiency and low heat loss, this valve should be located inside the vacuum chamber.
 - Manually operated - estimated mass is 1.8 kg.
 - Automatic - estimated mass is 4.5 kg.
- Vent Valve – valve used in hydrogen filling operations. From an energy efficiency and heat loss standpoint, the valve should be located inside of the vacuum chamber.
 - Manually operated – estimated mass is 1.8 kg.
 - Automatic – estimated mass is 4.5 kg.
- Fuel control and shut off valve – assumed to be part of the fuel cell system, not the hydrogen storage system.
- Pressure relief valve – safety valve to prevent excessive pressure inside the pressure vessel, associated tubing, and heat exchanger. Estimated mass is 2.7 kg.
- Vacuum valve – required to allow evacuation of the vacuum jacket. The valve is attached to a 1” half nipple and cross (see feed-through section below). A KF to Conflat adapter and the vacuum valve together weigh 0.63 kg.
- Rupture disks (2) – safety device to prevent excessive pressure in the vacuum jacket. Assembly includes small half-nipples welded to the vacuum shell port. The total estimated mass for both assemblies is 1.2 kg.

2.4 Gauges

- Hydrogen pressure – sensor, transmitter, and readout to monitor the hydrogen pressure in the tubing connected to the pressure vessel. Estimated mass is 0.7 kg.
- Vacuum – sensor, transmitter, and readout to monitor the vacuum level in the shell. Estimated mass is 0.9 kg.

- Fuel gauge – currently the storage tank capacity level is calculated from the pressure and temperature of the hydrogen in the vessel.

2.5 Feed-Throughs

- Thermocouples – the four thermocouples monitoring the temperature on the surface of the pressure vessel are routed through a half-nipple (0.23 kg) welded to the vacuum shell port, then a 1” cross (0.175 kg), and finally the thermocouple feed-through (0.05 kg).
- Heater – the electrical feed-through for the heater is attached to another branch of the 1” cross with an adapter. The feed-through and adapter mass is estimated to be 1.13 kg.
- Actuators – automatic operation of the fill and vent valves is anticipated for fueling operations. Actuator weights are included in the automatic valves listed above. Rotating feed-throughs are needed to couple the actuator outside the vacuum to the valves inside. The rotary feed-throughs weigh 0.6 kg.

2.6 Pressure Regulator

Regulates the hydrogen pressure from the tank (5,000 psig, max) to the engine (118 psia required for the fuel cell). The estimated weight of the regulator is 3.9 kg.

2.7 Tank Frame

Support structure for mounting the cryo-tank to the vehicle. Weight given by LLNL is 7 kg.

2.8 Heat Exchanger

Device to warm the hydrogen gas supplied to the engine. Analyses by ANL show that a 6.8 kW heat exchanger will be necessary to meet the maximum flow rate requirements. The corresponding heat exchanger mass is calculated to be 2.4 kg.

2.9 Conduit

Used to route and protect system wiring. Mass is estimated by LLNL to be 1.4 kg.

2.10 Tubing

Used to transport hydrogen from the tank, through the various valves, gauges, and heat exchanger, to the engine. Estimated to be 9 m of 0.065” wall, 1/2” stainless tubing, and weighing 2.9 kg.

2.11 Wiring

Used to electrically connect sensors to the electronic boards and the computer; thermocouples; supplying electrical power to the resistance heater; and to attach the grounding lugs between the tank and the vehicle. Estimated mass is 4.5 kg (LLNL).

2.12 Grounding Lugs

Safety feature to prevent a buildup of static charge that could result in a spark. Mass is estimated by LLNL to be 0.1 kg.

2.13 Nuts & Bolts

Used to mount and attach components of the system. Estimated mass is 1.1 kg (LLNL).

2.14 Miscellaneous Fittings

Used to make plumbing connections. Estimated mass is 1.8 kg (LLNL).

The weight of the original LLNL ex-vessel components was estimated as 68 kg. Using lighter valves, heat exchangers, and feed-throughs can reduce the weight to 60 kg, even though heavy actuators and rotary feed-throughs were added for automated valve operation.

3. Operation

3.1 Fueling

The cryo-tank is intended for storing hydrogen fuel on-board a motor vehicle. The tank is expected to be filled from a large stationary supply tank at a fueling station, much like vehicle refueling at current gas stations. Unlike existing gas stations that use a single fill port and dispense a volume of gas or diesel, however, the hydrogen supply station would likely require two ports, one for filling the on-board tank with cold gaseous or liquid hydrogen and a vent port to return warm hydrogen gas back to storage. This arrangement is necessary to maximize on-board hydrogen storage. Such an arrangement also dictates that the hydrogen be metered by mass and not volume and that the automatic shut-off be tied to the pressure in the on-board cryo-tank.

There appear to be two options for the source pressure needed to fill the vehicle tank. One is for the supply tank to contain an integral pump to force the hydrogen into the vehicle tank at the desired pressure. The other option is to pressurize the supply tank to 5000 psig and fill the vehicle tank by means of a pressure transfer. This second option is precluded in the use of both feed and vent valve connections.

In either case, once the connections are made, the supply valves on both the supply tank and the vehicle tank are opened. Once filled, the valves are closed and the hydrogen trapped in the supply lines is vented. The lines are then disconnected and the fueling process is complete.

3.2 Driving

To supply hydrogen to the engine or fuel cell to drive the vehicle, a signal is sent to the flow controller valve (part of the engine, not the fuel supply system) to open and allow the desired quantity of hydrogen to flow to the engine. The gas is replenished from the cryo-tank, through the heat exchanger, to the upstream side of the pressure regulator. The cryo-tank is pressurized in two ways. After the vehicle has remained stationary for some time, heat from the ambient environment is transmitted through the insulation to the pressure vessel at a rate of about one Watt. Depending on the duration of the idle period, this in-leakage of heat may be sufficient to develop a pressure of hydrogen gas that can operate the vehicle for some time. For longer trips, or when the supply side pressure at the regulator falls below the level needed by the engine, the auxiliary resistance heater is activated to vaporize additional liquid hydrogen or to pressurize the gaseous hydrogen to the needed upstream pressure.



APPENDIX C: Presentation to the FreedomCAR & Fuel Hydrogen Storage Technical Team

August 17, 2006, Southfield, MI



*Independent Review of
Cryo-Compressed Storage of Hydrogen:
Interim Report*

*R.K. Ahluwalia, V. J. Novick and J-K Peng
Hydrogen Storage Tech Team Meeting
Southfield, MI
August 17, 2006
Revised February 19, 2008*



A.U.S. Department of Energy laboratory
managed by The University of Chicago

Slide 1



*Cryo-Compressed Storage
Independent Review: Interim Report*

- Review of LLNL Design Data
 - Volumetric capacity
 - Gravimetric capacity
- ANL Analysis
 - Refueling dynamics
 - Discharge dynamics
 - Dormancy and boil-off losses
 - Refueling energy consumption
 - Discharge energy requirement



2

Slide 2

LLNL Cryo-Tank

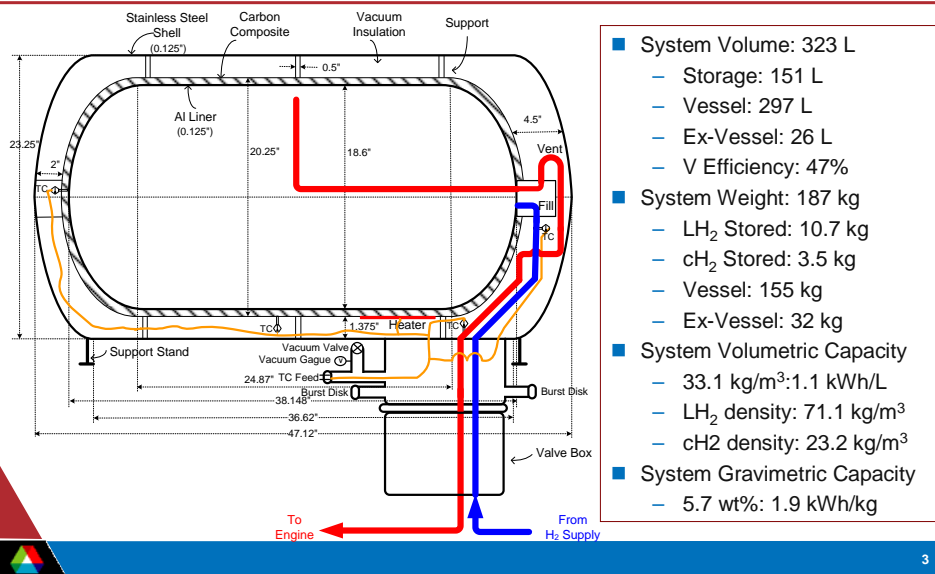

Slide 3

LLNL Cryo-Tank Ex-Vessel Components

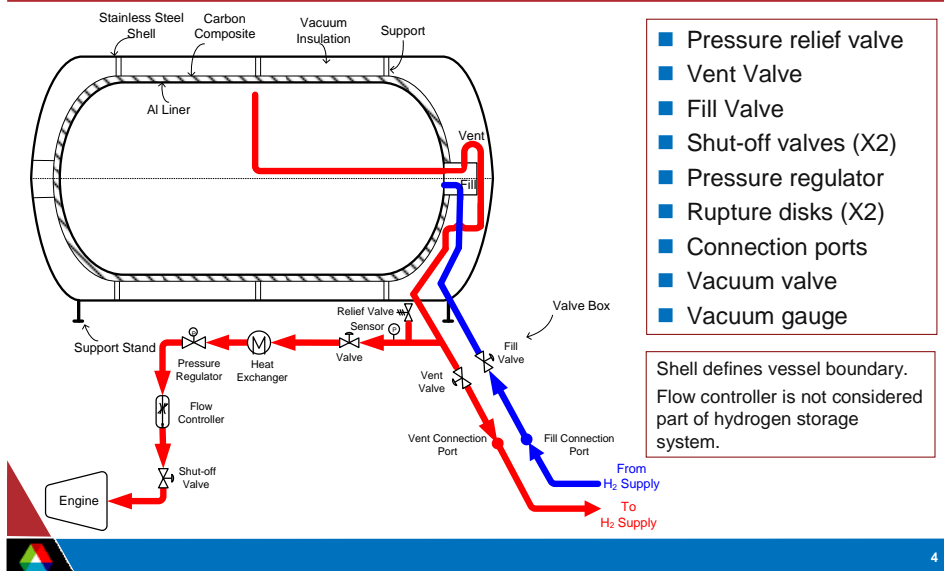

Slide 4

Cryo-Tank with Some Modifications

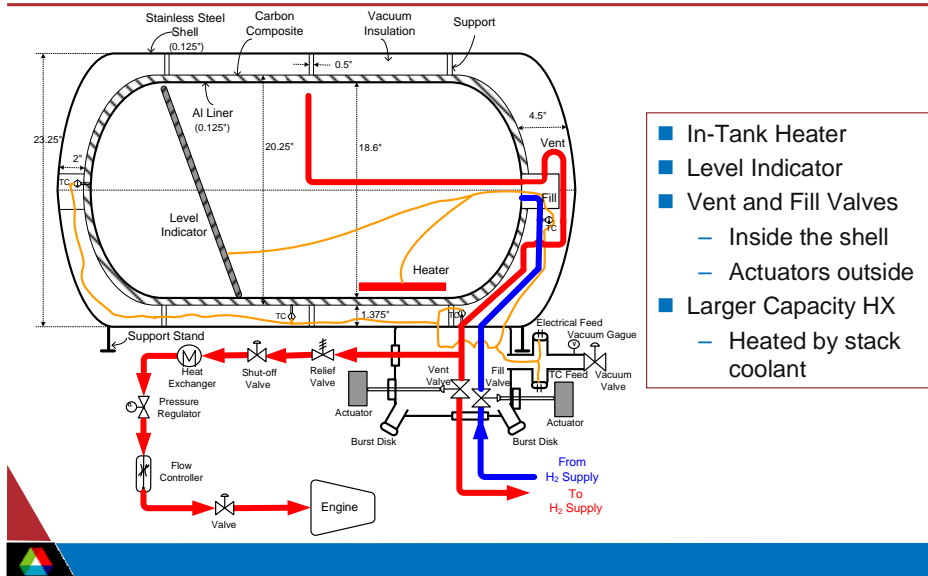

Slide 5

Weight and Volume Distribution

- SS shell and valve box account for ~44% and CF ~30% of total weight
- Insulation represents ~32% of total volume

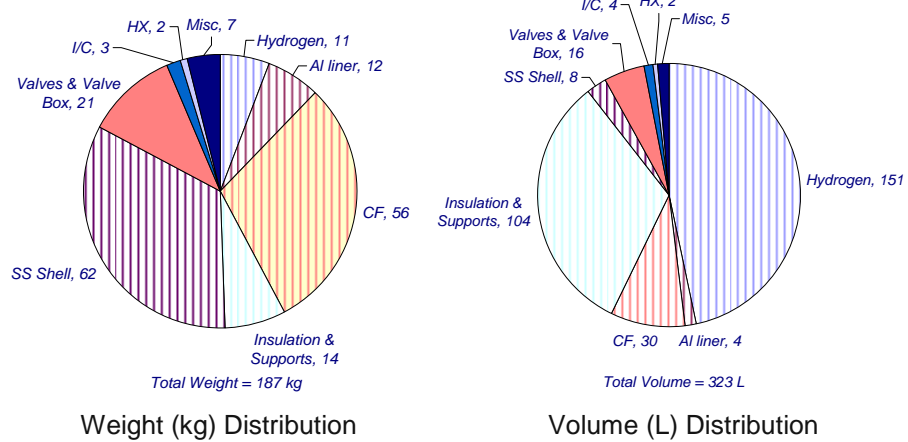

Slide 6

Outstanding Issues

Filling Issues

- 1) Filling Station
 - Standardized connection: Is vehicle H_2 allowed into station?
 - Station control of vehicle fill and vent valves
- 2) Heat Transfer Mitigation
 - Valves in the vacuum shell with external actuators vs. outside the shell
- 3) Tank Fill Ports
 - Inlet pipe with multiple spray nozzles
- 4) Indication of Tank Fill
 - Pressure
 - Temperature to sense liquid H_2 in vent line

Heat Exchanger Issues

- 1) Sized for 2 g/s LH_2
- 2) Is a valve needed between tank and HX to minimize heat transfer to the tank
- 3) Heat transfer medium: air or stack coolant
- 4) Designed for maximum storage P because regulator is located downstream

Flow Control Issues

- 1) Supply Pressure
 - Is electrical heater needed to maintain minimum delivery P?
- 2) Pressure Regulator
 - Not compatible with low T, must be downstream of HX

Other Issues

- 1) Tank Level Indicator
 - Do we need to measure level beside P & T?
 - Current pressure rating on electrical feedthru at 20 K is 4000 psi
- 2) Aluminum vs. stainless steel shell
- 3) Manual vs. remotely actuated valves

7

Slide 7

Liquid Refueling Interface

Liquid Feed - Gas Bleed System with Separate Fill and Vent Lines

- (A) Low pressure fill (LPF): LH_2 transfer pump
- Gaseous hydrogen vented at low pressure
 - After filling tank to 100% capacity, LH_2 heated to minimum delivery pressure (8 bar)
- (B) High pressure fill (HPF)
- Gaseous hydrogen vented at 350 bar

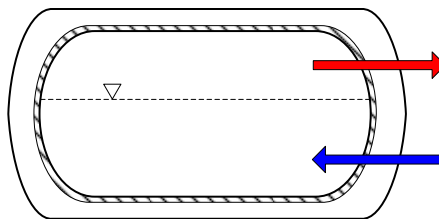

8

Slide 8

Transient Model for Charge, Discharge and Dormancy

- Variable speed LH2 refueling pump, 75% isentropic efficiency
- In-tank electric heater to maintain H₂ at minimum delivery pressure
- Dormancy based on 425-bar set point pressure for relief valve
- Stored hydrogen, Al liner and CF assumed isothermal
- Debye theory for T-dependent specific heats of Al liner and CF
- BWR EOS for H₂ (REFPROP)

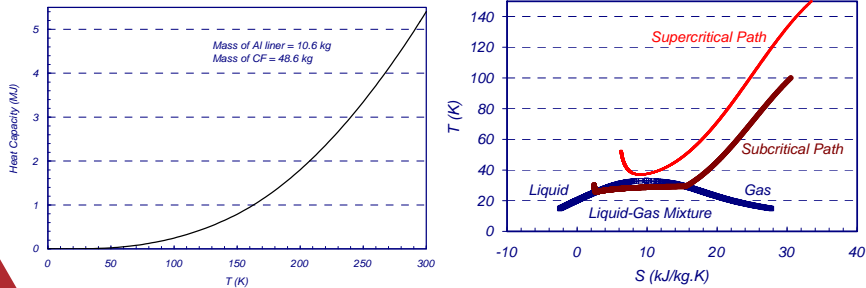

Slide 9

High-Pressure LH₂ Refueling Storage Dynamics: Cryo-Gas

- Initial T = 300 K, P = 8 bar
- Change of slope in H₂ stored signifies onset of venting
- 24.1 kg of LH₂ charged, 10.7 kg stored as cryo-gas at 350 bar, 63 K

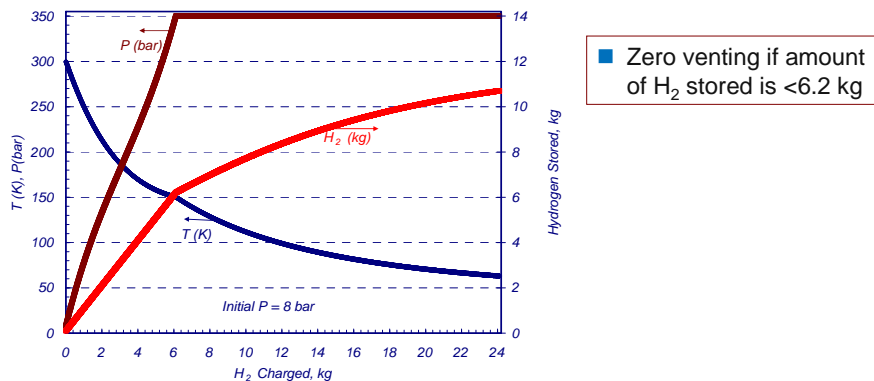

Slide 10

High-Pressure LH₂ Refueling Storage Dynamics: LH2

- Initial T = 50 K, P = 8 bar
- No venting of H₂ as the maximum pressure reached is only 58 bar

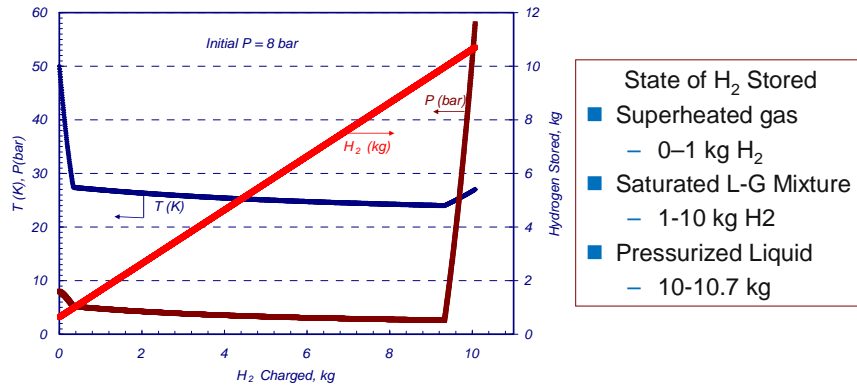

Slide 11

High-Pressure LH₂ Refueling Cryo-Gas or LH2?

- Cryo-gas if initial T > 120 K, P < 350 bar if initial T < 180 K
- No venting of H₂ if the initial T < 180 K
- Final LH2 P is 58 – 95 bar for initial T between 30 and 100 K

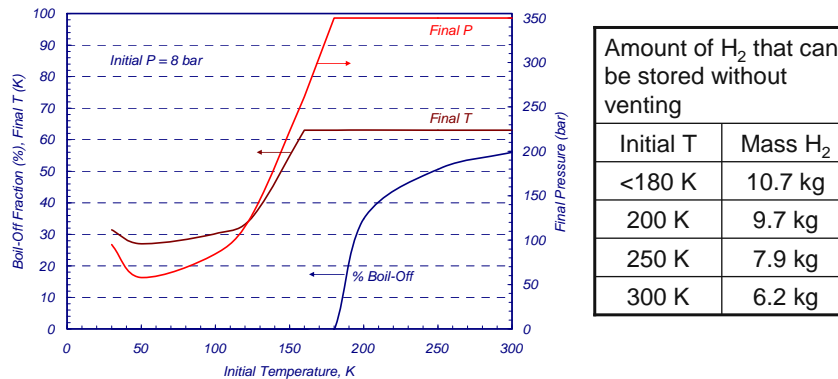

Slide 12

Low-Pressure LH₂ Storage Discharge Dynamics at Full Flow (1.6 g/s)

- Subcooled liquid until H₂ decreases to 8.2 kg, saturated liquid-gas mixture if 8.2–1.6 kg, superheated gas for <1.6 kg

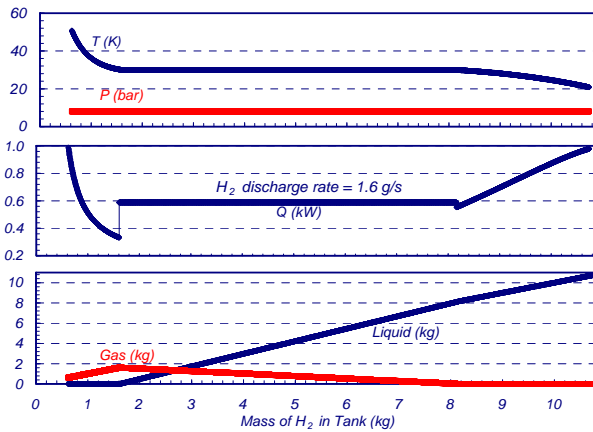

- P maintained at 8 bar by heating liquid (>8.2 kg H₂), generating gas (8.2-1.6 kg), or heating gas (<1.6 kg)
- Amount of recoverable H₂ depends on the heater rating

Slide 13

Medium-Pressure LH₂ Storage Discharge Dynamics at Full Flow (1.6 g/s)

- Initial P = 58 bar, T = 27 K
- No heat input required until stored H₂ decreases to 10 kg

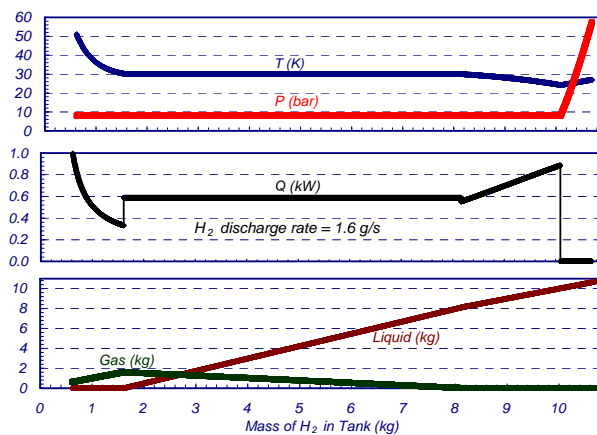

Slide 14

High-Pressure Cryo-Gas Storage Discharge Dynamics

■ Initial P = 350 bar, T = 63 K

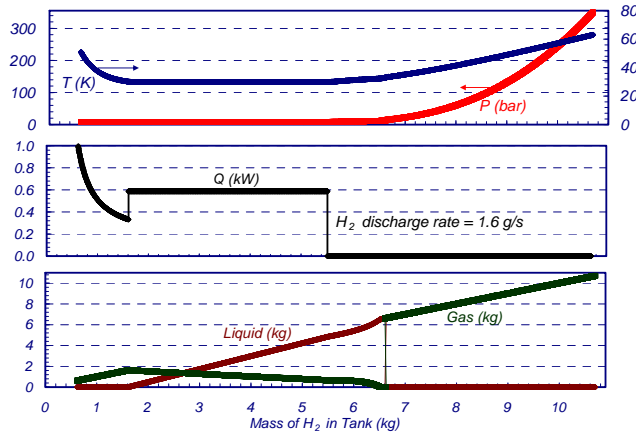

- Tank initially cools as H₂ is withdrawn. Supercritical gas transforms to liquid as amount of H₂ decreases to 6.6 kg.
- Heat input is needed when P decreases to 8 bar.

15

Slide 15

High-Pressure Cryo-Gas Storage Discharge Dynamics

■ Initial P = 350 bar, T = 63 K

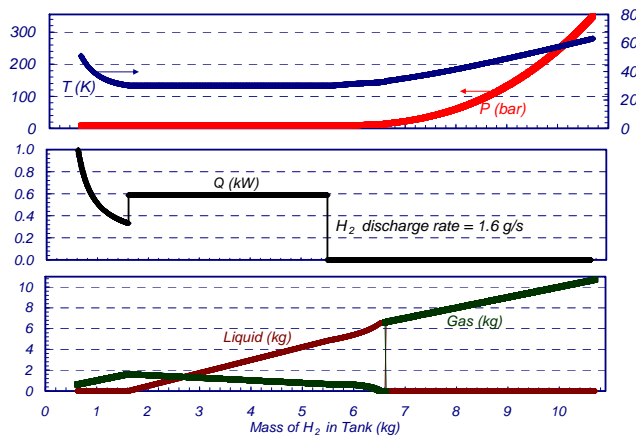

- Tank initially cools as H₂ is withdrawn. Supercritical gas transforms to liquid as amount of H₂ decreases to 6.6 kg.
- Heat input is needed when P decreases to 8 bar.

15

Slide 16

Dormancy and H₂ Loss

- HPG: Cryo-gas at 350 bar, 63 K
- MPL: Medium pressure liquid at 58 bar, 27 K
- LPF: Low-pressure liquid at 8 bar, 20.9 K
- Heat absorption capacity: Q corresponding to final T = 50°C

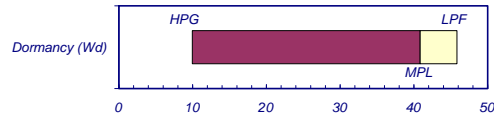

Longer dormancy if H₂ stored as liquid

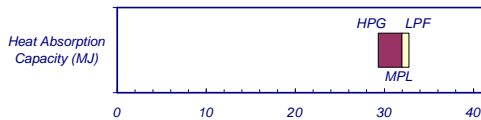

Higher heat absorption capacity if H₂ stored as liquid

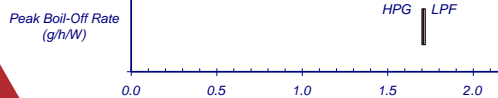

Peak boil-off rate independent of H₂ initial state

17

Slide 17

Summary High-Pressure LH₂ Refueling Option

- Recoverable gravimetric capacity of system: 5.4 wt%
- Recoverable volumetric capacity of system: 31.1 kg/m³

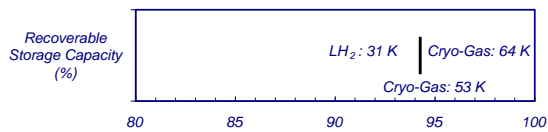

Recoverable storage capacity depends on minimum delivery pressure and heat input

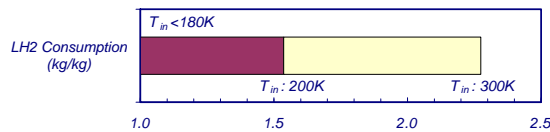

Initial temperature depends on prior refueling and driving events

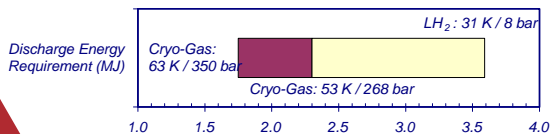

Includes electrical heat input and in-leakage of heat

18

Slide 18

Summary of Sensitivity Analysis: Recoverable System Storage Capacity

- More radical changes needed to satisfy 2010 volumetric capacity target of 45 kg/m³

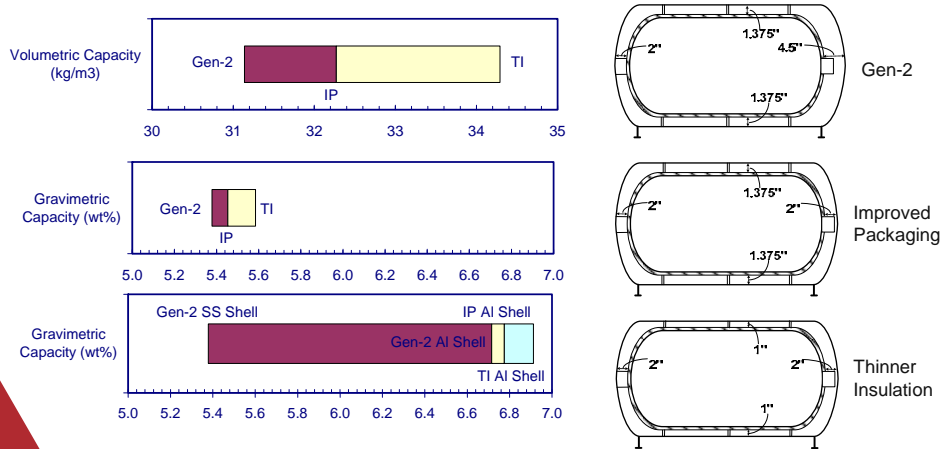

Slide 19

Low-Pressure LH₂ Refueling Storage Dynamics

- Initial T = 300 K
- Tank bled to liquid inlet pressure
- 2.2 kg of LH₂ fed to cool tank to boiling point of H₂ - 20.3 K at 1 bar

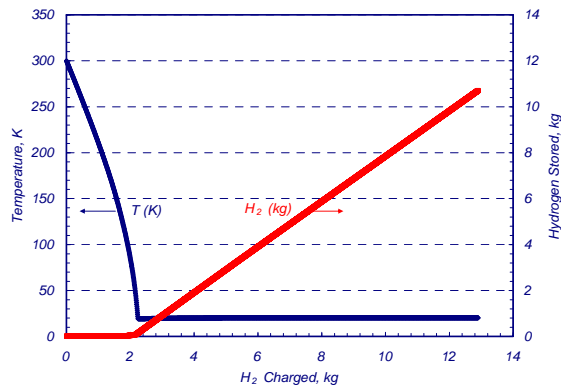

Slide 20

Low-Pressure LH₂ Refueling Energy Consumption

- Hydrogen boil-off is a measure of liquefaction energy consumed in cooling the tank.
- Energy penalty: 22% at 300 K initial temperature, 1.2% at 30 K

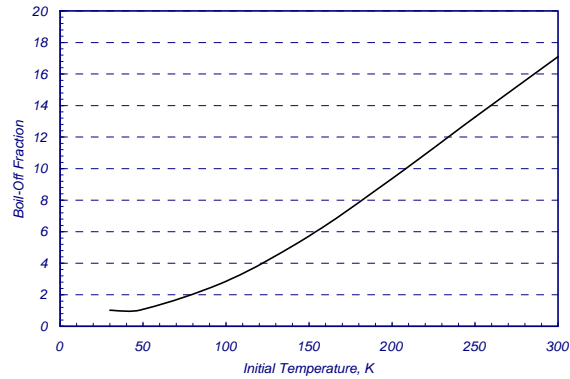

Slide 21

21



APPENDIX D: Independent Review of Cryo-Compressed Hydrogen Storage Systems

List of Formal Presentations and Discussions (2006-2008)

1. May 19, 2006, Scope and schedule for independent assessment of cryo-compressed hydrogen storage.
2. July 18, 2006, Progress report on ANL's independent assessment.
3. August 16, 2006, Teleconference with BMW, DOE and LLNL to discuss ANL's analysis of cryo-compressed hydrogen storage.
4. August 17, 2006, Presentation at Hydrogen Storage Tech Team Meeting, "Independent Review of Cryo-Compressed Storage of Hydrogen: Interim Report," R. K. Ahluwalia, V. J. Novick and J-K Peng.
5. September 27, 2006, Teleconference with DOE, LLNL, NREL and TIAX.
6. December 5th, 2007 US Freedom Car cryo-compressed workshop
7. March 31st, 2008 NHA cryo-compressed workshop
8. June 9th, 2008 Annual Merit Review side-meeting cryo-compressed workshop

APPENDIX E: TIAX Cost Analysis: Cryo-compressed and Liquid Hydrogen System Cost Assessments

S. Lasher, K. McKenney, Y. Yang, M. Hooks
June 10, 2008



Analyses of Hydrogen Storage Materials and On-Board Systems

Project ID # ST1 Cryo-compressed and Liquid Hydrogen System Cost Assessments

DOE Merit Review
June 10, 2008

Stephen Lasher
Kurtis McKenney
Yong Yang
Matt Hooks

TIAX LLC
15 Acorn Park
Cambridge, MA
02140-2390
Tel. 617-498-6108
Fax 617-498-7054
www.TIAXLLC.com
Reference: D0268

This presentation does not contain any proprietary, confidential, or otherwise restricted information

Timeline

- ◆ Start date: June 2004
- ◆ End date: June 2009
- ◆ 54% Complete

Barriers

- ◆ Barriers addressed
 - B. Cost
 - C. Efficiency
 - K. System Life Cycle Assessments

Budget

- ◆ Total project funding
 - DOE share = \$1.5M
 - No cost share
- ◆ FY07 = \$170k
- ◆ FY08 = \$350k (plan)

Collaboration

- ◆ Argonne and other National Labs
- ◆ Centers of Excellence and other developers
- ◆ Tech Teams and other stakeholders



SL/042108/00266 ST1_Lasher_H2 Storage_v1.ppt 1

Approach On-Board Assessment

The on-board cost and performance assessments are based on detailed technology assessment and bottom-up cost modeling.

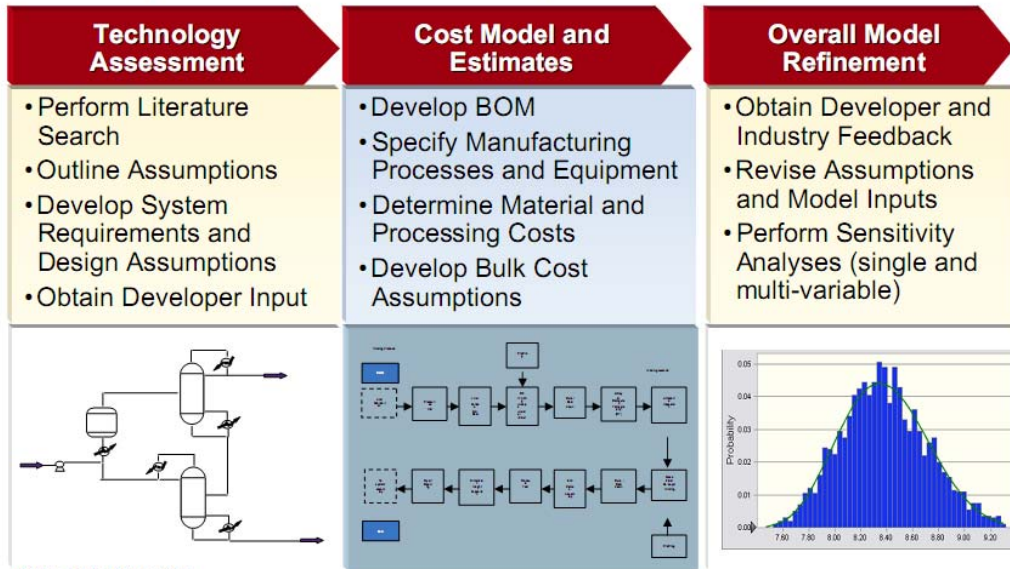

BOM = Bill of Materials

SL/042108/00266 ST1_Lasher_H2 Storage_v1.ppt 3

We completed on-board cryogenic system assessments and updated compressed and SBH cost estimates since the last Review.

- ◆ Completed cryo-compressed and preliminary liquid hydrogen (LH₂) on-board storage system cost assessments
 - Based on the LLNL 2nd generation cryo-compressed system with modifications
 - Included processing and detailed component cost estimates
 - Updated carbon fiber cost based on industry feedback (\$13/lb fiber)
 - \$14/kWh and \$8/kWh (preliminary) for cryo-compressed and LH₂, respectively
- ◆ Updated compressed hydrogen (cH₂) on-board storage system estimates
 - Based on Tech Team and industry feedback for pressure requirements and material cost (\$13/lb fiber)
 - \$17/kWh and \$27/kWh for 5,000 and 10,000 psi storage, respectively
- ◆ Updated Sodium Borohydride (SBH) on-board and off-board system estimates
 - Based on latest information provided by developers (primarily MCell and Rohm and Haas)
 - The higher SBH concentration assumed by MCell results in reduced on-board system size, but still does not meet the DOE 2010 targets
 - New off-board regeneration pathways could reduce costs, but the resulting selling price is still in excess of the goal of \$2-3 kg/H₂ using the base case assumptions



Progress Cryo-compressed System Schematic

The LLNL second generation tank design was the basis of our cryo-compressed storage system cost assessment.

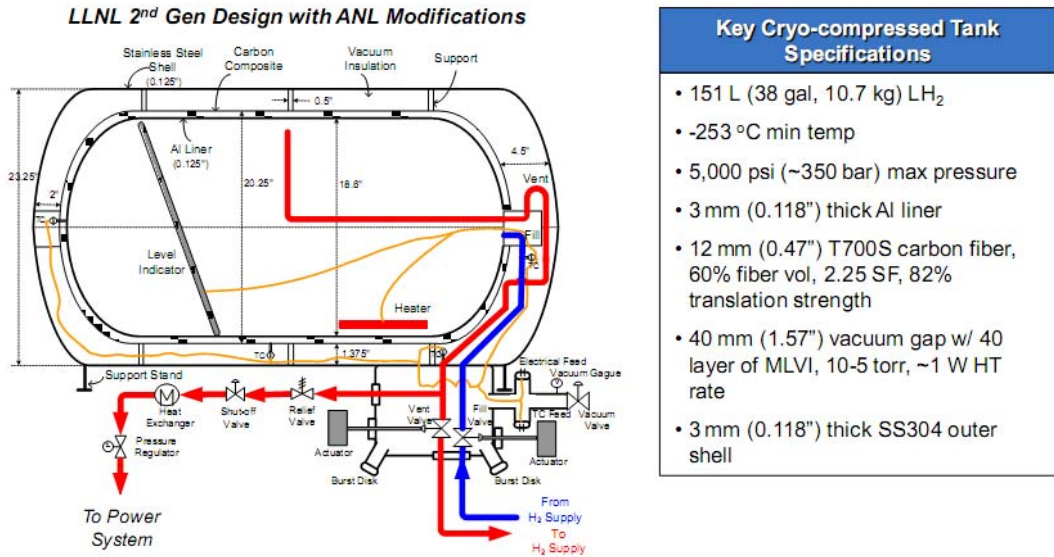

Additional modifications were made based on literature and developer feedback.



Processing and assembly/inspection costs were generated by developing process maps, and obtaining developer feedback.

Processing Steps for Cryo-tank Insulation, Assembly, and Inspection

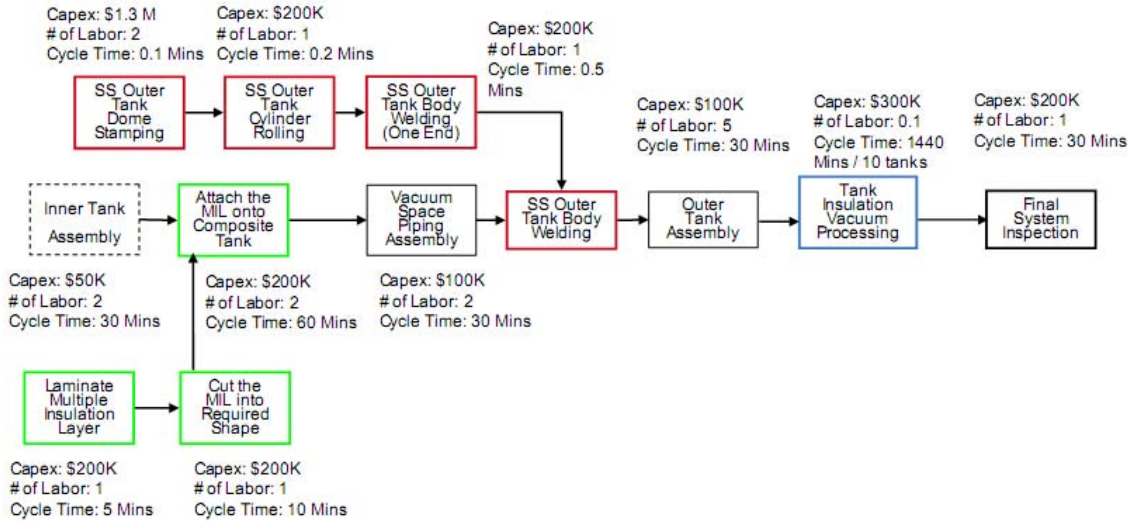

The costs of key processing steps were estimated from capital equipment, labor, and other operating costs assuming high volumes (500,000 units/year) and a high level of automation.

Cryo-compressed Key Processing Steps	Process Cost per Tank	% of Total Processing Cost
Al Liner Fabrication, Assembly, & Inspection	\$76	13%
Carbon Fiber Winding Process	\$56	10%
SS Vacuum Shell Fabrication	\$14	2%
MLVI Wrapping	\$108	18%
In-vessel Assembly	\$42	7%
Ex-vessel Assembly	\$128	22%
Vacuum Processing	\$119	20%
Final Inspection	\$40	7%
Total	\$583	-

Processing costs make up 13% of the total cryo-compressed system cost.

Note: Details provided in Backup Slides.



Carbon fiber and cryogenic valves are the dominant costs, accounting for approximately 50% of the overall system cost.

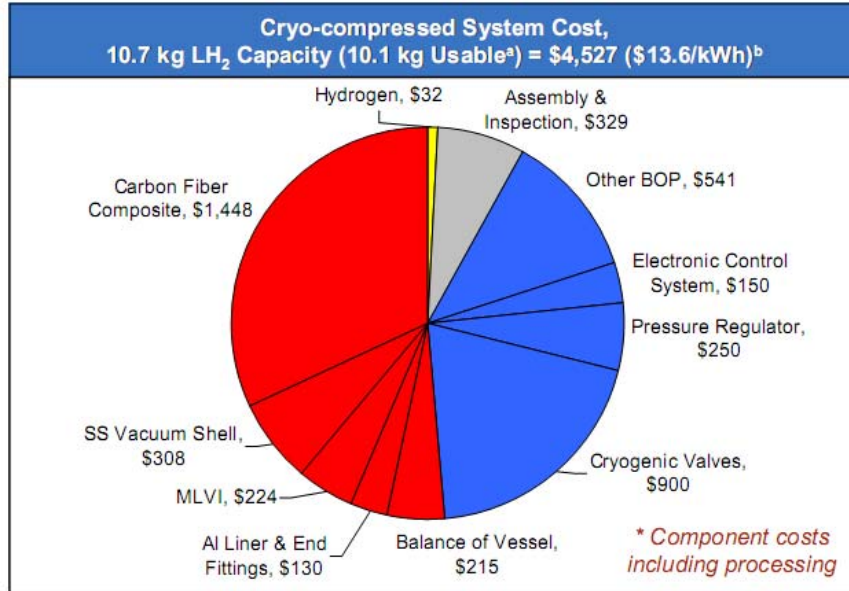

^a Costs per kWh are based on a projected 10.1 kg (336 kWh) "usable" hydrogen assuming 94% drive cycle utilization (ANL 2006).
^b The total system cost could be reduced by ~5% by using an aluminum shell rather than stainless steel.



Variability in the carbon fiber (CF) related costs and valve costs can significantly affect the overall cost of the cryo-compressed system.

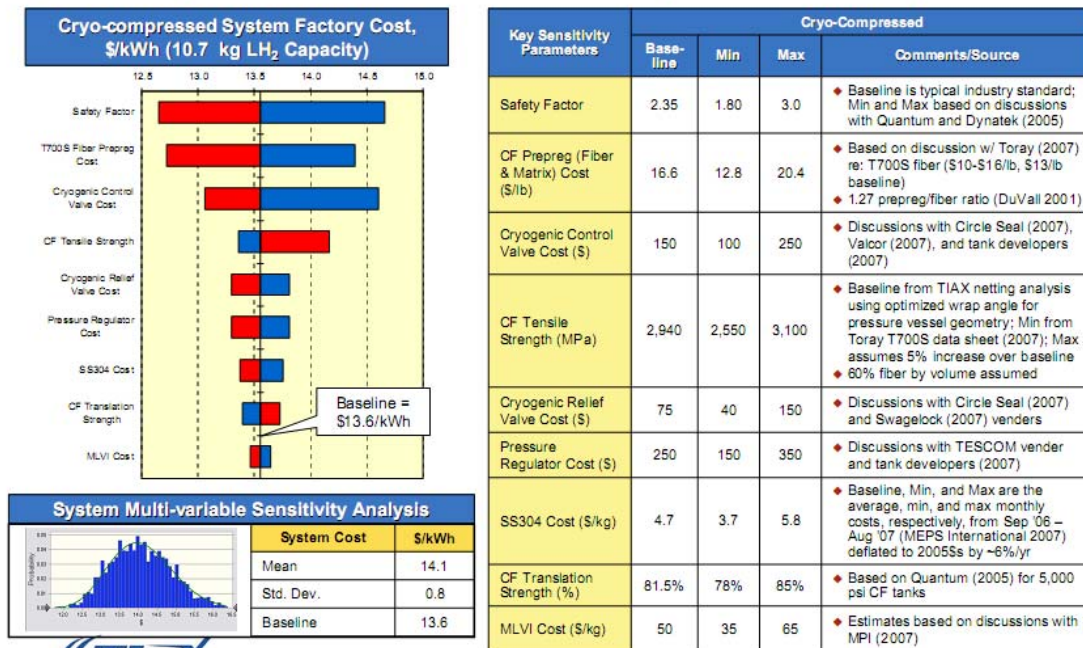

The cryo-compressed tank design was used as a starting point for the liquid hydrogen system cost assessment.

Sketch of Key LH₂ System Components

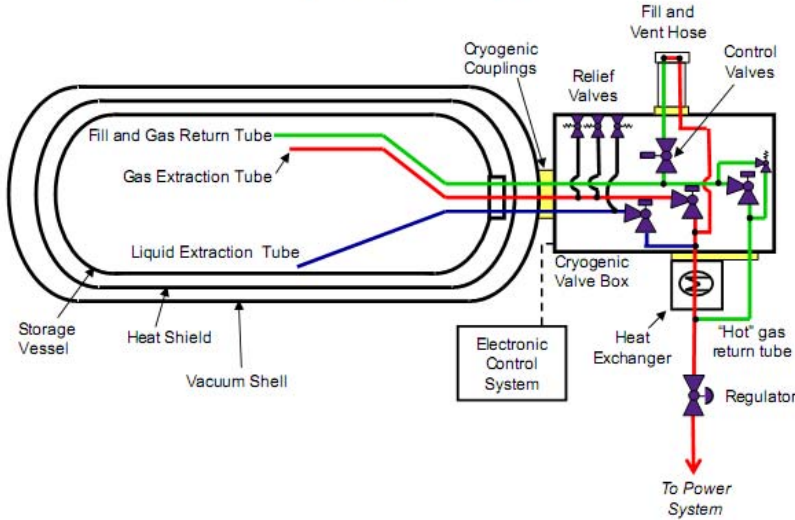

Liquid Hydrogen Tank Specifications
• 151 L (38 gal, 10.7 kg) LH ₂
• -253 °C min temp
• 3 mm (0.118") thick Al inner tank
• 40 mm (1.57") vacuum gap w/ 40 layer of MLVI, 10-5 torr, ~1 W HT rate
• 3 mm (0.118") thick SS304 outer shell
• 10% tank ullage requirement

Modifications were made based on literature and developer feedback.



Control and relief valves account for a combined 30% of the total cost, but costs are relatively evenly distributed among major components.

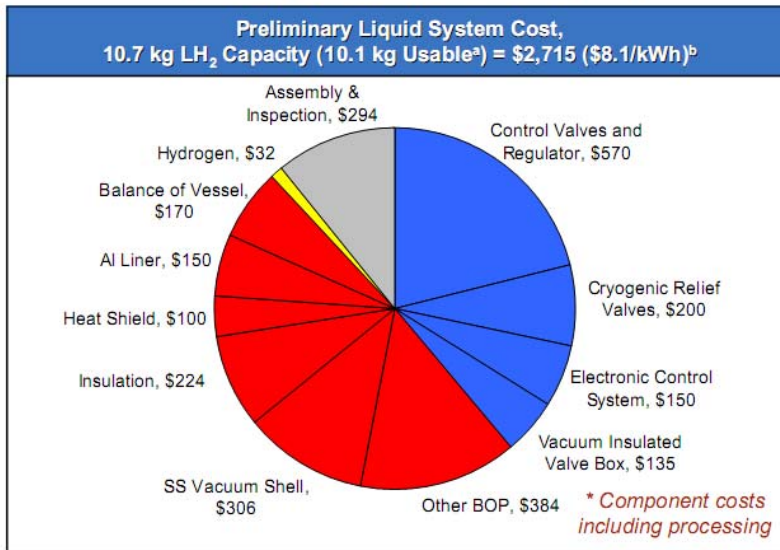

^a Costs per kWh are based on a projected 10.1 kg (336 kWh) "usable" hydrogen assuming 94% drive cycle utilization (ANL 2006) for cryo-compressed drive cycle efficiency. Utilization needs to be updated for LH₂.

^b The total system cost could be reduced by ~8% by using an aluminum shell rather than stainless steel.



Variability in the cryogenic valve costs can significantly affect the overall cost of the liquid system.

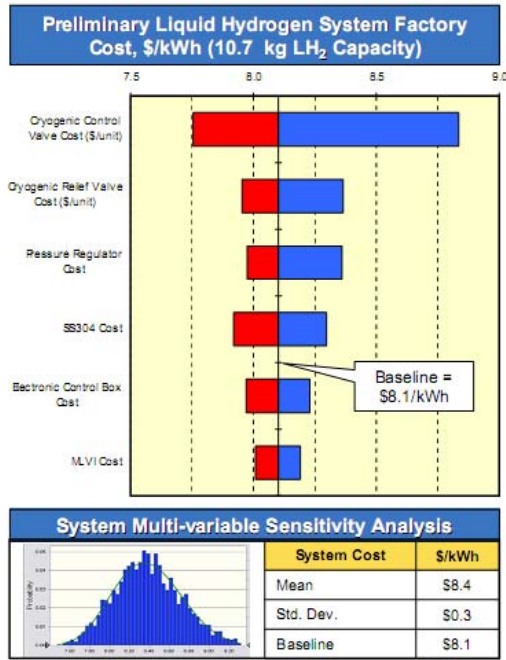

Key Sensitivity Parameters	Liquid Hydrogen System			Comments/Source
	Base-line	Min	Max	
Cryogenic Control Valve Cost (\$/unit)	105	70	175	◆ Discussions with Circle Seal (2007), Valcor (2007), and tank developers (2007)
Cryogenic Relief Valve Cost (\$/unit)	50	35	75	◆ Discussions with Circle Seal (2007) and Swagelock (2007) vendors
Pressure Regulator Cost (\$/unit)	150	100	250	◆ Discussions with Circle Seal (2007), Valcor (2007), and tank developers (2007)
SS 304 Cost (\$/kg)	4.7	3.7	5.8	◆ Baseline, Min, and Max are the average, min, and max monthly costs, respectively, from Sep '06 – Aug '07 (MEPS International 2007) deflated to 2005\$ by ~6%/yr
Electronic Control Box Cost (\$/unit)	150	100	200	◆ Estimate based on interviews with technology experts (includes microcontroller, valve relays, analog inputs, and power regulator)
MLVI Cost (\$/kg)	50	35	65	◆ Estimates based on discussions with MPI (2007)



SL/042108/D0268 ST1_Lasher_H2 Storage_v1.ppt 12

Results Comparison System Cost

The cryo-compressed and liquid hydrogen on-board systems are projected to be cheaper than pressurized-only options.

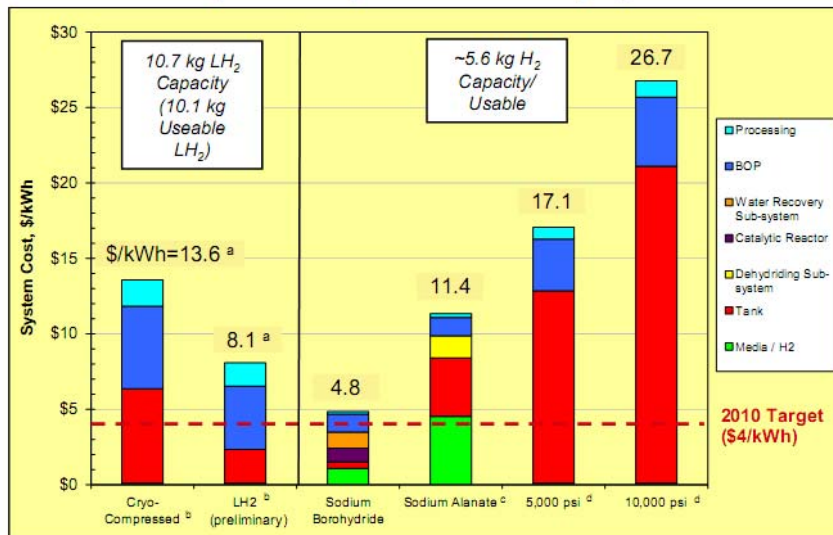

^a Normalizing the cryo-compressed and liquid systems for 5.6 kg of usable hydrogen storage results in system costs of approximately \$20/kWh and \$14/kWh, respectively.
^b An aluminum shell (rather than SS) offers approximately 5% and 8% costs savings for the cryo-compressed and liquid systems, respectively.
^c The sodium alanate system requires high temp waste heat for hydrogen desorption, otherwise the usable hydrogen capacity would be reduced.
^d Includes updated carbon fiber cost estimate, 2007.



SL/042108/D0268 ST1_Lasher_H2 Storage_v1.ppt 13

The liquid system meets the 2010 weight target, and the cryo-compressed system would also meet the target with an aluminum shell^a.

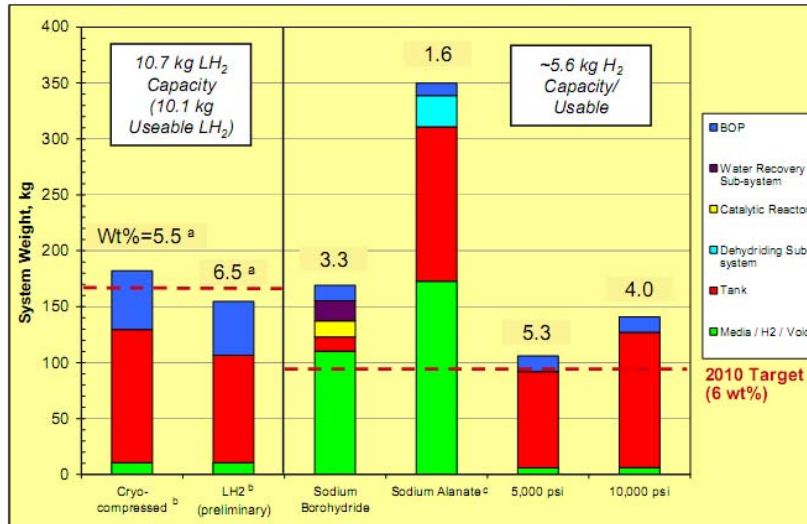

^a Normalizing the cryo-compressed and liquid systems for 5.6 kg of usable hydrogen storage results in system gravimetric capacities of approximately 4.0 wt% and 4.4 wt%, respectively.
^b An aluminum shell (rather than SS) increases gravimetric capacities to 7wt% and 9 wt% for the cryo-compressed and liquid systems, respectively.
^c The sodium alanate system requires high temp waste heat for hydrogen desorption, otherwise the usable hydrogen capacity would be reduced.



None of the on-board storage systems evaluated to date meet the 2010 volume target given our base case assumptions.

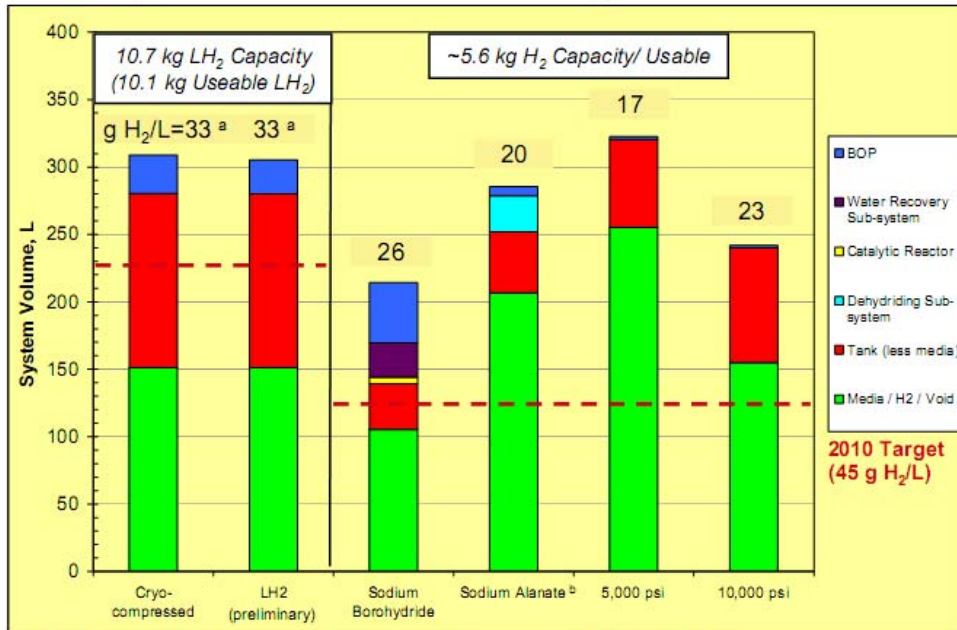

Note: Volume results do not include void spaces between components (i.e., no packing factor was applied).
^a Normalizing the cryo-compressed and liquid systems for 5.6 kg of usable hydrogen storage results in system volumetric capacities of approximately 28 g/L each.
^b The sodium alanate system requires high temp waste heat for hydrogen desorption, otherwise the usable hydrogen capacity would be reduced.



We will focus on the liquid hydrocarbon- (HC) and ammonia borane-based hydrogen storage systems for the remainder of FY08.

- ◆ Complete on-board assessments of APCI liquid HC system and begin assessment of ammonia borane system
 - Solicit feedback from developers and coordinate with ANL on final system requirements and design assumptions
 - Specify manufacturing processes and equipment and determine material and processing costs
 - Use sensitivity analysis to account for uncertainties and potential future technology developments
- ◆ Conduct off-board analyses for the liquid HC and ammonia borane systems
 - Finalize designs and cost inputs for the complete fuel chain
 - Estimate refueling cost and Well-to-Tank energy use and GHG emissions for the fuel chain
- ◆ Continue to work with DOE, H2A, other analysis projects, developers, National Labs, and Tech Teams to revise and improve past system models
 - Including finalize liquid hydrogen storage system results based on developer (e.g., Air Liquide) and stakeholder feedback



Summary

We have completed certain aspects of on-board and off-board evaluations for eight hydrogen storage technologies.

Analysis To Date		CH ₂	Alanate	MgH ₂	SBH	Cryo-comp	LH ₂	AC	Liquid HC
On-Board	Review developer estimates	√	√		√	√	√	√	√
	Develop process flow diagrams and system energy balances	√	√		√	√	√		WIP
	Independent performance assessment (wt, vol)	√	√		√	√	√*		WIP
	Independent cost assessment	√	√		√	√	√*	WIP	WIP
Off-Board	Review developer estimates	√		√	√		√		√
	Develop process flow diagrams and system energy balances	√		√	√		√		√
	Independent performance assessment (energy, GHG)	√			√		√		WIP
	Independent cost assessment	√			√		√		WIP
Overall	WTT analysis tool ^a	√							
	Solicit input on TIAX analysis	√	√		√	√	√*	WIP	WIP

* Preliminary results under review.

^a Working with ANL and H2A participants on separate WTT analysis tools.

☐ = Not part of current SOW
WIP = Work in progress



APPENDIX F: Summary of BMW Comments on Cryo-Compressed Hydrogen Storage Concept

Throughout the assessment of cryo-compressed tank technology developed by LLNL, technical experts from BMW provided valuable input and feedback. BMW is a leader in the development of hydrogen-powered internal combustion engine vehicles and is a strong advocate of liquid hydrogen technology for on-board vehicular hydrogen storage. The following slides were provided by Tobias Brunner and summarize BMW's perspective on the cryo-compressed approach.

A number of targets, similar to the DOE targets, are shown and the potential to meet several of them using cryo-compressed tanks appears favorable. One of the key advantages is that loss-free dormancy time may be significantly improved. For large systems (150 l of net fuel volume or more), the loss-free dormancy time could potentially be improved from 3 days for liquid hydrogen to between 20 or even to 40 days using cryo-compressed tanks. For smaller cryo-compressed hydrogen storage systems (e.g. 4kg to about 8kg hydrogen stored), the mean loss-free dormancy time range may be between 7 days and 20 days depending on the vessel geometry, the amount of stored hydrogen and on insulation quality. The application of cryo-compressed storage is particularly of interest for such smaller vessels from 4kg to 8kg of hydrogen, whereas for large storage systems it appears as if liquid hydrogen may be the preferred option in terms of weight, volume and cost- as long as the car is used regularly enough to avoid significant boil-off loss. Cost and durability/cycle life are key issues that have yet to be addressed. Discussions will continue to be held to further refine the analyses. In summary, BMW has provided beneficial feedback to DOE from the OEM perspective in assessing the value of federally-funded R&D efforts on cryo-compressed tank technology.

BMW Group
CleanEnergy
Fuel Systems
Detroit 12/05/07
Page 16

Cryo-compressed Hydrogen Vehicle Storage. Solution for a high capacity, no-loss H₂ storage?

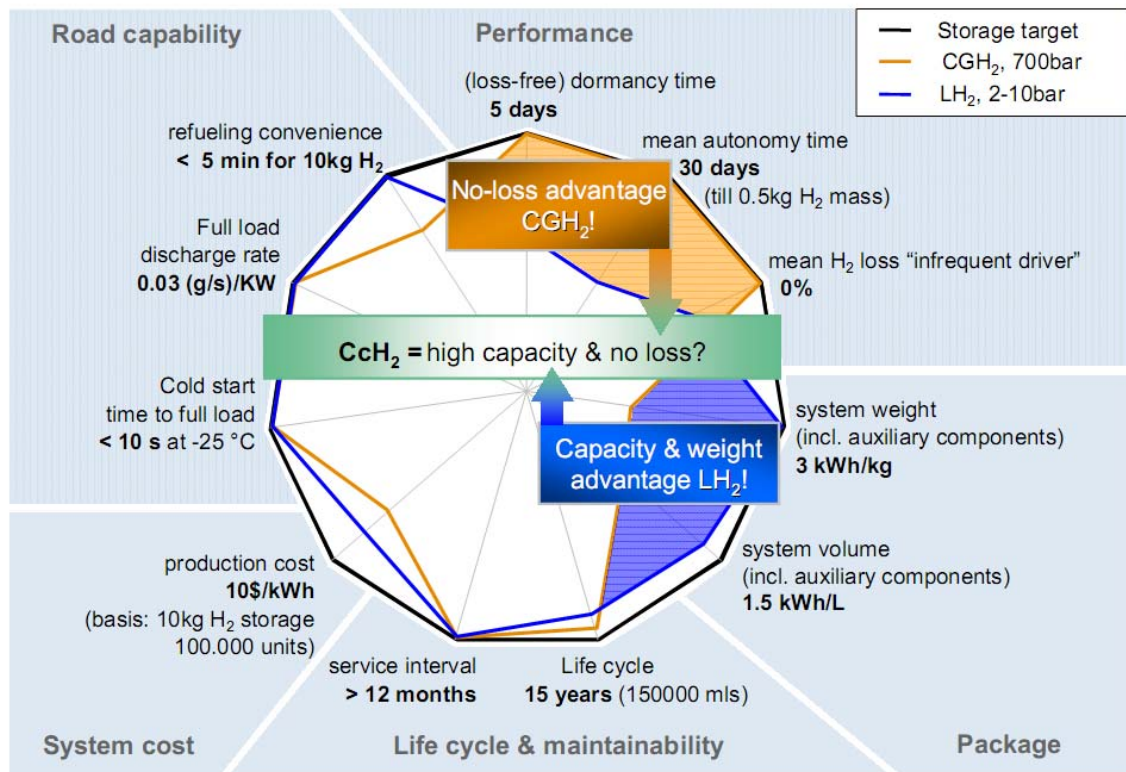

Cryo-compressed Hydrogen Vehicle Storage. C_cH₂: Physically denser than LH₂.

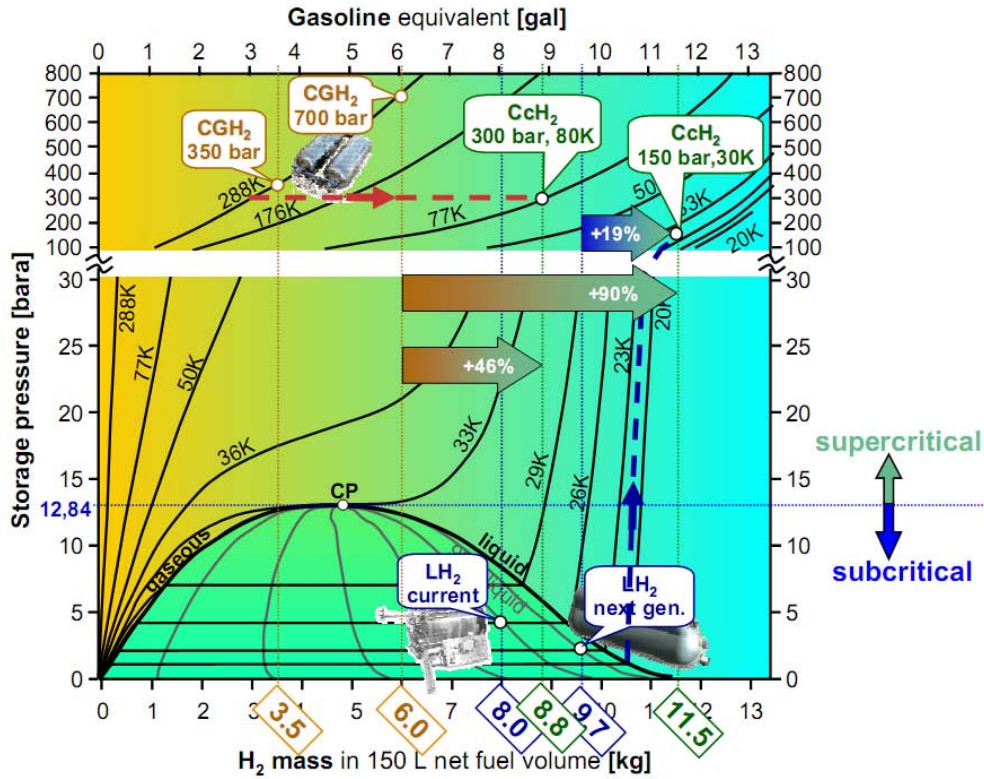

Cryo-compressed Hydrogen Vehicle Storage. Low vent rates and high autonomy.

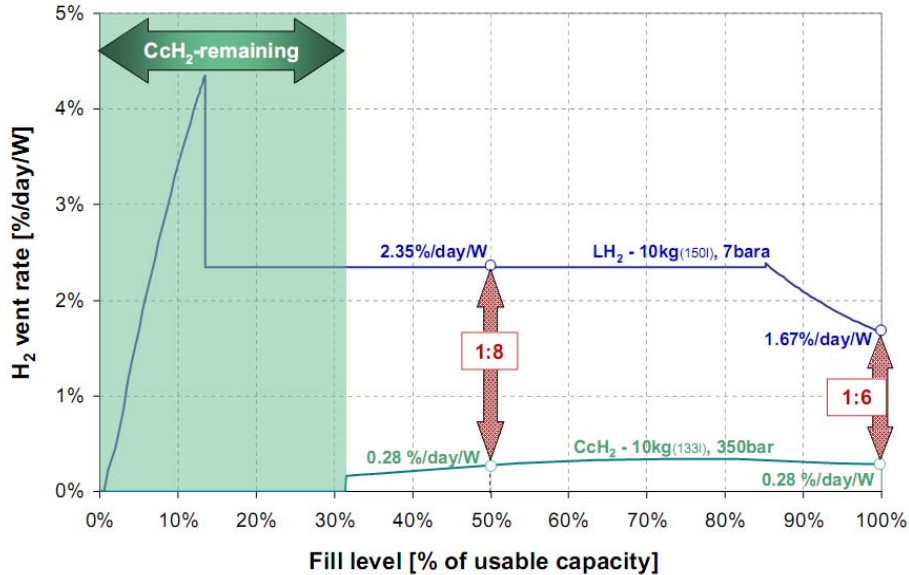

Cryo-compressed Hydrogen Vehicle Storage. "CCH₂ recipe": Reducing implications.

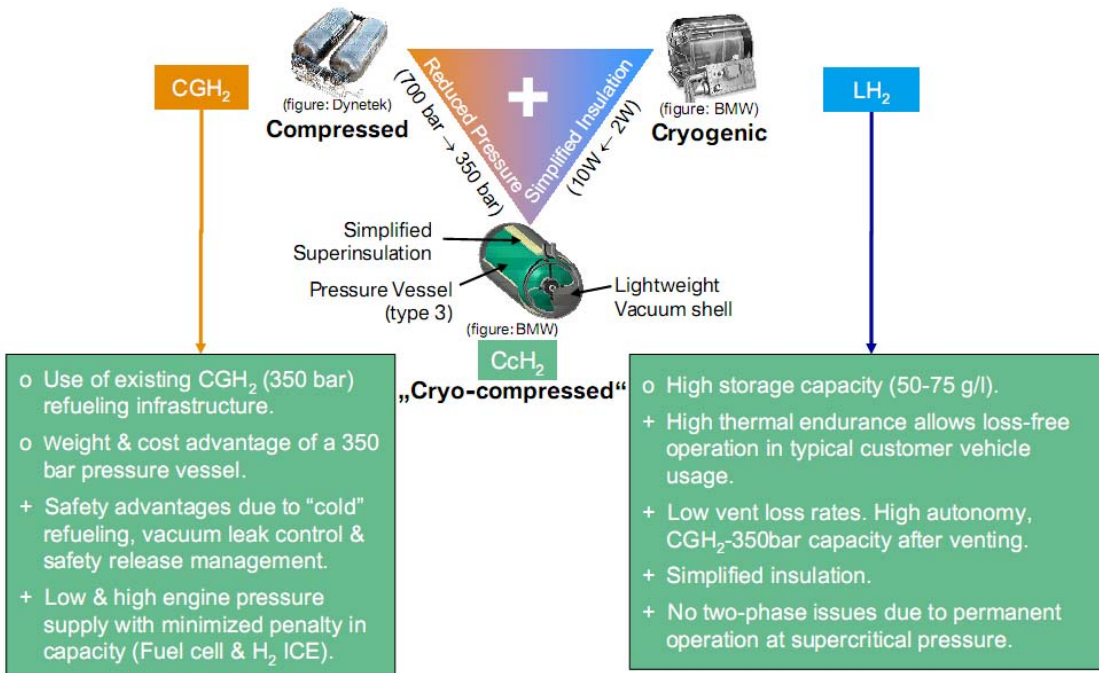

Cryo-compressed Hydrogen Vehicle Storage. High-density, no-loss hydrogen storage.

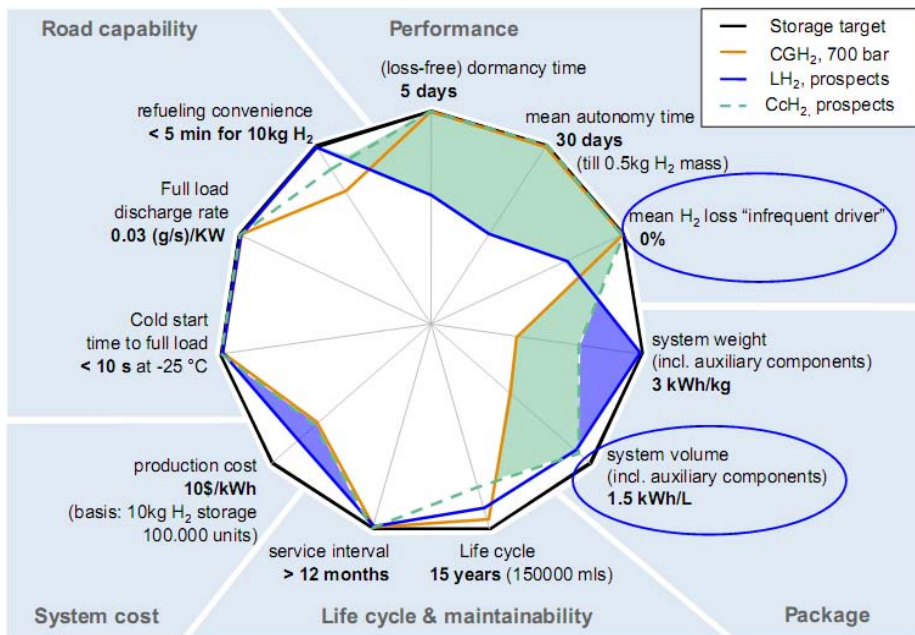

APPENDIX G: Summary of DOE Systems Integrator Input

The DOE Hydrogen Program's Systems Integration office provided support throughout the assessment of cryo-compressed tank technology during 2006. Thomas Sheahen and Michael Duffy convened multiple conference calls and meetings as listed below to aid in a thorough assessment of the technology.

Teleconferences/meetings:

1. June 22, 2006: Tanks independent assessment schedule for FreedomCAR & Fuel Partnership Tech Team discussion
2. July 18, 2006: ANL review of their findings thus far
3. August 11, 2006: Conference Call on Cost Sensitivity Analysis
4. August 16, 2006: The objectives of the meeting were to:
 - (1) hear Rajesh Ahluwalia's presentation on ANL's analysis of "cryo-compressed tank" technology and LLNL's approach
 - (2) get feedback from participants on the analysis/the technology.
5. August 17, 2006: Tech Team meeting;
 - (1) LLNL (cryo-compressed tanks)
 - (2) ANL (independent assessment of cryo-compressed tanks)
6. September 27, 2006: final conf call on the cryo-compressed tank review and the final opportunity to raise any issues, concerns, points that need clarification, assumptions, recommendations for future analysis, etc.

-
- 1** Cryo-Compressed Storage Independent Review: Scope and Schedule, Dr. Rajesh Ahluwalia, Argonne National Laboratory, June, 2006
(Attached as Appendix A)
 - 2** Review of Cryo-Compressed Hydrogen Storage Systems by Argonne National Laboratory, R. K. Ahluwalia, V. J. Novick, and J.-K. Peng, October, 2006 (Attached as Appendix A)
 - 3** Cryo-Tank Design Elements for H₂ Storage, V. J. Novick, Argonne National Laboratory, September, 2006 (Attached as Appendix B)
 - 4** Independent Review of Cryo-Compressed Storage of Hydrogen: Interim Report, R.K. Ahluwalia, V. J. Novick and J-K Peng, Argonne National Laboratory, Hydrogen Storage Tech Team Meeting, Southfield, MI, August 17, 2006 (Attached as Appendix C)
 - 5** United States Patent, US 6,983,611 B2, Storage Container for Cryogenic Media, January 10, 2006
 - 6** System Level Analysis of Hydrogen Storage Options, DOE Annual Progress Report 2007; by Rajesh K. Ahluwalia, Argonne National Laboratory http://www.hydrogen.energy.gov/pdfs/progress07/iv_f_1_ahluwalia.pdf
 - 7** Analyses of Hydrogen Storage Materials and On-Board Systems, DOE Merit Review Presentation; by TIAX, S. Lasher, K. McKenney, Y. Yang, June, 2008 http://www.hydrogen.energy.gov/pdfs/review08/st_1_lasher.pdf (Attached as Appendix E)
 - 8** Analyses of Hydrogen Storage Materials and On-Board Systems, DOE Merit Review Presentation; by TIAX, S. Lasher, K. McKenney, Y. Yang, June, 2008 http://www.hydrogen.energy.gov/pdfs/review08/st_1_lasher.pdf (Attached as Appendix E)

These other cost estimates were for smaller hydrogen storage capacities (i.e., 5.6 kg usable hydrogen), which will tend to make them somewhat more expensive on a \$/kWh basis.
 - 9** Analyses of Hydrogen Storage Materials and On-Board Systems, DOE Merit Review Presentation; by TIAX, S. Lasher, K. McKenney, Y. Yang, June, 2008 http://www.hydrogen.energy.gov/pdfs/review08/st_1_lasher.pdf (Attached as Appendix E)
 - 10** R. K. Ahluwalia, T. Q. Hua and J. K. Peng, "Fuel Cycle Efficiencies of Different Automotive On-Board Hydrogen Storage Options," Int. J. Hydrogen Energy (2007), doi: 03.021
 - 11** B. Kelly, "Liquefaction and Pipeline Costs," Hydrogen Delivery Analysis Meeting, Columbia, MD, May 8-9, 2007
 - 12** Tobias Brunner, personal communications and T. Brunner, J. Lutz, presentation at National Hydrogen Association Conference, San Antonio, TX, 2007