

# 2006 DOE Hydrogen Program Review--Hydrogen Filling Station

UNLV Research Foundation

Presented by R. F. Boehm and R. Hurt

UNLV Center for Energy Research

April 21, 2006

Project ID

#TVP 8

# Overview

## Timeline

- Project start 6/12/03
- Project end 12/31/06
- % complete 78
- % complete, spent 55

## Budget

- Total project funding
  - DOE \$12,336,073
  - Contractor \$3,469,469
- FY05 Funding \$4.9M
- FY06 Funding \$3.4M

## Barriers

- Barriers addressed (technology validation)
  - Vehicles
  - Hydrogen Refueling Infrastructure
  - Hydrogen from Renewable Resources.

## Partners

- Project collaborations with: Air Products, Altair Nanomaterials, Hydrogen Solar, IF LLC, Las Vegas Valley Water District, Proton Energy Company, Kells Automotive, NREL

# Objectives

- To demonstrate renewably-based hydrogen generation and means of utilization of this.
- To develop new means of hydrogen production, including high pressure PEM electrolysis and the application of Tandem Cells<sup>TM</sup>. Improve the performance of these devices and bring down costs.
- To assist in developing a hydrogen-based business climate in the Desert Southwest including companies with expertise in hydrogen applications.

# Objectives

- To exhibit success with conversion technology in vehicles and transfer this to local businesses.
- To further the codes and safety efforts of DOE particularly for the Desert Southwest.
- To provide a roadmap for hydrogen development in Nevada and the neighboring region of the Desert Southwest.

# Approach

- In partnership with LVVWD, a major potential customer for hydrogen technology applications, to install this technology in the field.
- Build a facility where generation and utilization technology can be developed, demonstrated and refined.
- Work with and encourage local companies to move into hydrogen technology development.
- Further work on codes and standards.
- Collaborate with stakeholders and experienced personnel to roadmap a hydrogen-development scenario for our area.

# Technical Accomplishments/ Progress/Results

- Components of phase I hydrogen filling station (HFS) system have been completed. PV array configuration has been selected and is being purchased by LVVWD.
- Have developed phase II HFS hardware (including a high pressure electrolyzer) and are in the process of installation.
- An electric vehicle has been converted to be a Hybrid FCV that demonstrates an effective and relatively low cost method for this type of conversion.
- Direct cylinder injection has been demonstrated locally and is being optimized. The application to a vehicle is underway. Plans are being developed for larger scale conversions, including a H<sub>2</sub> V-8 ICE conversion with FC for auxiliary power.

# Technical Accomplishments/ Progress/Results

- A CFD model for understanding performance of Tandem Cells™ has been developed. Results have shown tradeoffs in performance that have been valuable in improved design directions.
- Developed the program for terminal voltage - current density and power density - current density relationships for water electrolysis
- Proposed a photoelectrochemical model for the electrolysis process inside solar Tandem Cell™
- An on-sun facility for evaluation of Tandem Cells™ is nearing completion. Data from this as well as from the CFD modeling, and from physical insights, are being used to develop a parametric prediction model for performance.
- Studies of balance of plant aspects for Tandem Cell™ applications have been initiated
- Developed new substrates for Tandem Cell™
- Demonstrate new PEC material durability for Tandem Cells™

# Technical Accomplishments/ Progress/Results

- Conventional pressure electrolysis/compression/distribution system was built, tested, and is being installed - 0.5 kg H<sub>2</sub>/day
- 1,100 psig electrolysis/compression/distribution system completely designed, built, tested, delivered. Site design completed. Site work initiated.
- 400 psig dryer design completed and hardware procurement in progress.



# Technical Accomplishments/ Progress/Results

- A hydrogen codes and safety workshop was held prior to the Powergen Renewable Energy Conference. Fire officials and others were briefed by industry experts on current standards, codes, and safe design practices.
- Plans have been formulated for a hydrogen roadmapping meeting that will bring together stakeholders with people experienced in this type of effort to lay out a development strategy for Nevada. The meeting will be held in June.

# Future Work

- Operate complete renewably-based HFS system (generation and utilization) and optimize its performance. System to be operated by LVVWD.
- Convert a V8 ICE powered pickup to hydrogen fuel with in-cylinder injection, and replace the alternator with a fuel cell to supply electrical requirements.
- Configure a FC/ICE hybrid vehicle.
- Develop a fundamental model of Hydrogen Solar Tandem Cells™ calibrated with experimental (on-sun) results, and configure a balance of plant for these units' development.
- Perform fundamental studies with Proton Energy on improvement of electrolyzer membranes.

# Summary

- Several of the milestones of the project were delayed because of contracting problems. Phases I and II of project to be completed in the next two months. This includes two phases of filling station and two vehicle conversions.
- We have been successful in developing local hydrogen generation and utilization capability that will greatly facilitate our work toward developing a hydrogen economy in Nevada.

# Summary

- We hosted a Hydrogen Codes/Standards/ Safety workshop that attracted key officials in the local area to participate. Industry experts presented relevant topics and gave insight to the attendees.
- A roadmapping workshop is scheduled for June 20 in Las Vegas to define paths to hydrogen utilization in Nevada.
- 14 graduate and undergraduate students have been involved with this project effort.

# Responses to Previous Year Reviewers' Comments

- **Some comments questioning the development of solar concepts in a hydrogen program:** Two ways solar energy is used in this program. **a)** One is as the driver for the first two phases of the filling station. This uses conventional approaches, and the system is being purchased by the LVVWD, not us or DOE. Significant industrial interest has been shown in this aspect of the project. **b)** The second was in the study of Tandem Cells™, combined solar cell/electrolyzers, which are cutting edge hydrogen generation technology. We are assisting with the development of these. It is not experimental solar technology, rather experimental hydrogen generation technology.

# Responses to Previous Year Reviewers' Comments

- **The project is too diverse, scattered, etc.** As originally conceived, proposed and pursued, it was to assist in introducing the local region to renewably-based hydrogen generation and typical methods of utilization, and to develop local industries in these areas. This was to be done while pushing the envelope on selected generation and utilization technologies. This thrust is being pursued precisely.

# Responses to Previous Year Reviewers' Comments

- **Should not be working on vehicle development. Instead have the car companies do this.** This also was part of the original proposal. There were three reasons why this is a critical element of the program. **a)** It was very clear that the car companies would not furnish vehicles to a project just getting off the ground, or perhaps even later (they told us that). Ours is a cost effective approach to supplying vehicles. **b)** We wanted to develop local, commercial expertise in vehicle conversions. **c)** Our host was extremely interested in building hydrogen expertise inside its organization. We are posting success in all aspects, and now we are attracting the interest of some car companies.

# Responses to Previous Year Reviewers' Comments

- **The project is significantly behind schedule.** To a degree this is true, primarily because of the bid process and having difficulty securing competent contractors (for what is in fact a small--another problem--construction project) in the very busy construction industry in Las Vegas. While our schedule is lagging, our expenditures are on track with the amount of progress. Virtually all aspects are moving forward at a good rate now, and phases I and II will be completed only slightly late compared to the phase II scheduling.



# Publications and Presentations

R. Boehm, Y. Baghzouz, and T. Maloney, "A Strategy for Renewable Hydrogen Market Penetration", International Solar Energy Conference, Orlando, Florida, 2005.

R. Boehm, "Safety Approaches in UNLV Hydrogen Project," New Mexico Hydrogen Business Council, Sante Fe, New Mexico, 2006

M. Popek, Y. Baghzouz, and R. Boehm, "Added Value of Hydrogen Fuel Cells in Electric Vehicles," NHA Annual Hydrogen Conference 2006, Long Beach, California.

R. Maldin, R. Hurt, J. Gardner, M. Popek, Y. Baghzouz, and R. Boehm, "Performance Evaluation of Fuel Cell-Battery Hybrid Vehicle, NHA Annual Hydrogen Conference 2006, Long Beach, California.

A. Khan, K. Dreier, N. Borland, T. Maloney, R. Boehm, Y. Baghzouz, M. Cardin, O. Chow, H. Garabedian, S. Goyette, M. Kowalski, S. Porter, E. White, "Real World Experience with Renewable Hydrogen Fueling Stations," PowerGen Renewable Energy Conference, Las Vegas, 2006

S. Deshmukh and R. Boehm, "Mathematical Modeling of a Solar-Hydrogen System for Residential Applications," International Solar Energy Conference, Denver, Colorado, 2006.

R. Boehm, Y. Baghzouz, R. Hurt, R. Mauldin, E. Bulla, R. Fifield, and J. Gardner, "Development of a Renewably-Based Hydrogen Generation/Utilization System," International Solar Energy Conference, Denver, Colorado, 2006.

S. Deshmukh, Y. Baghzouz, and R. Boehm, "Design of a Grid-Connected PV System for a Hydrogen Filling Station," International Solar Energy Conference, Denver, Colorado, 2006

# Critical Assumptions and Issues

- First critical assumption was that we would easily find an engineering firm and contractor to construct the slab. Since we are constrained by the bid process, it took three times going out for bid to have success, and the low bidder on the engineering part had to subcontract some of the work. This all delayed the project immensely.

# Critical Assumptions and Issues

- Another critical assumption was that it would be relatively straight forward to procure direct cylinder injectors for hydrogen in ICEs. We were able to find only one company that was willing to sell us what we needed, and their unit has failed twice. It remains to be seen if this will be successful. We also pursued our own device design, and this is what we are currently using for our work.

# Hydrogen Filling Station

**200 psig PEM Electrolysis with PV**



Phase I System Built and Tested; PV Compatible  
2 kg H<sub>2</sub>/day generated at 200 psig;  
7 kg H<sub>2</sub> compressed and stored at 6,250 psig

**1,100 psig PEM Electrolysis**



Phase II System Built and Tested  
0.5 kg H<sub>2</sub>/day generated at 1,100 psig  
H<sub>2</sub> compressed and stored at 6,250 psig

**400 psig  
PEM Electrolysis**



Phase III System – build in progress  
12 kg H<sub>2</sub>/day generated at 400 psig  
Utilize same compressor as Phase I to provide  
Low Cost Approach for fueling  
Additional 12 kg H<sub>2</sub> storage at 6,250 psig

# Cumulative Power Consumption for Phase I

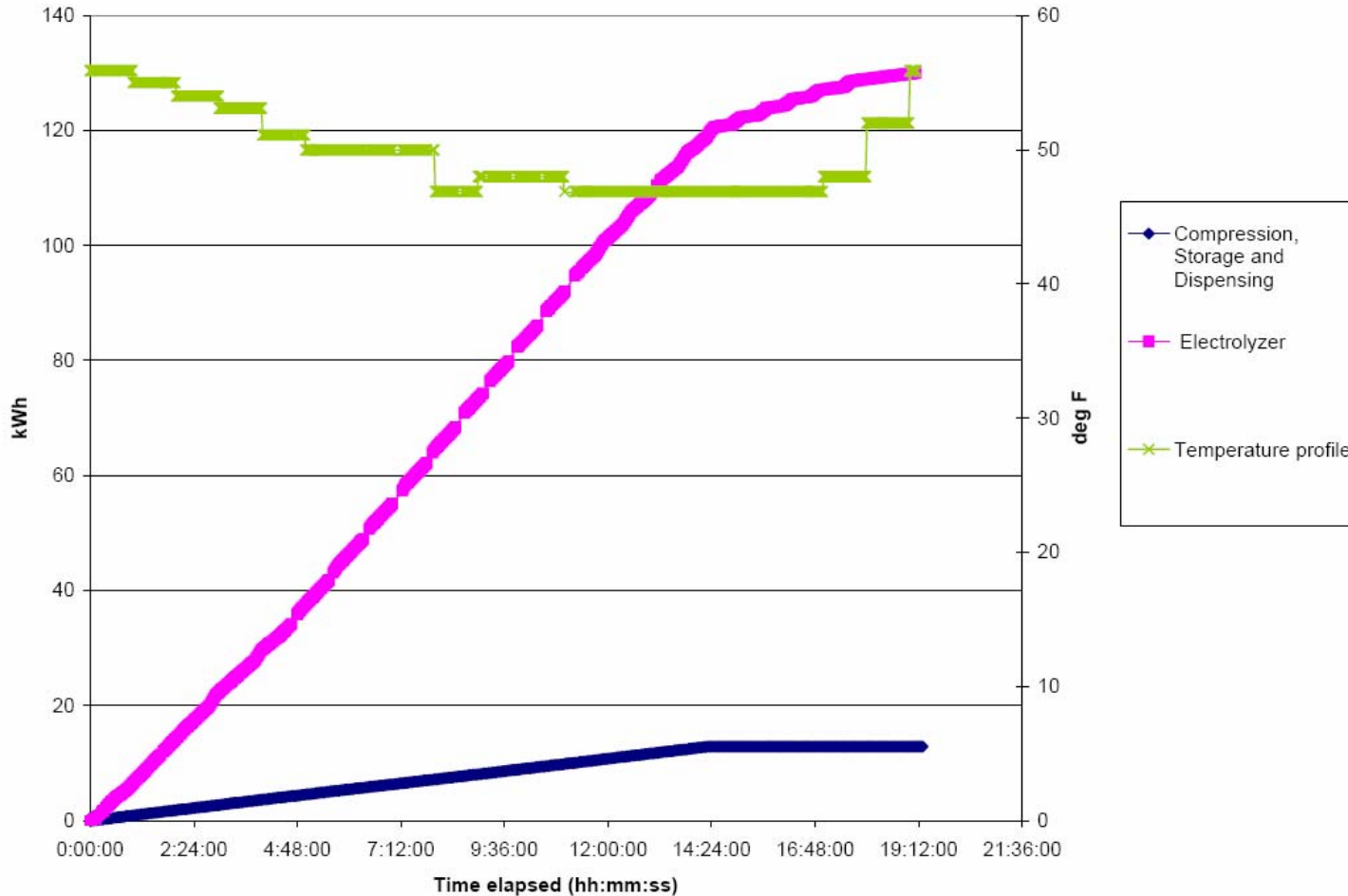

Cumulative power consumption with heaters operating at 45°F

# Projected Hydrogen Production using PV for Phase I

(Based on 2 Kg H<sub>2</sub>/Day, Las Vegas, NV Insolation Data)

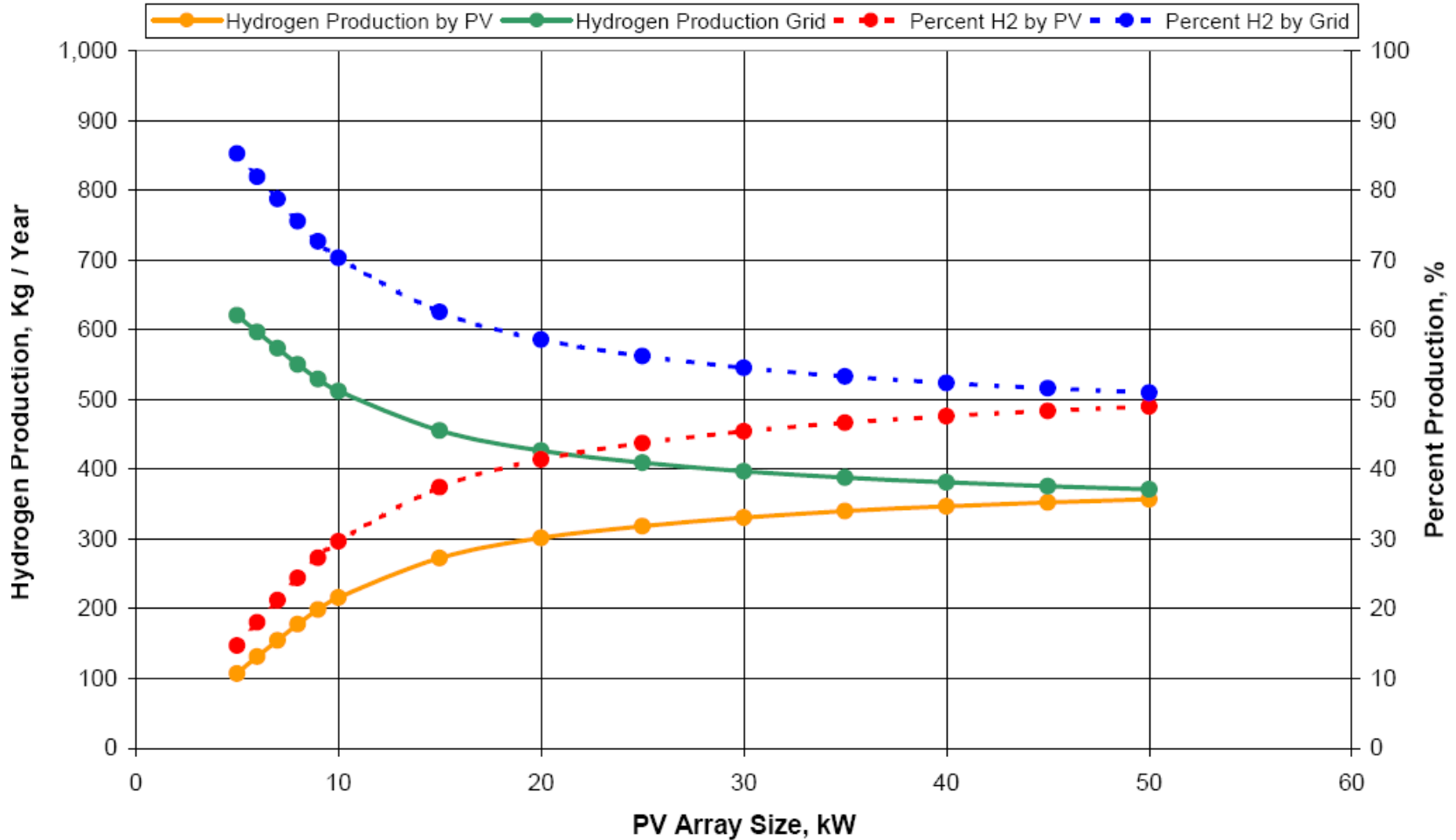

# High Pressure PEM Electrolysis UNLV Phase II

## Advanced High Pressure Cell Stack

3-Cell (Avg) Verification, 1100 psid H<sub>2</sub>, 36°C, (2005)

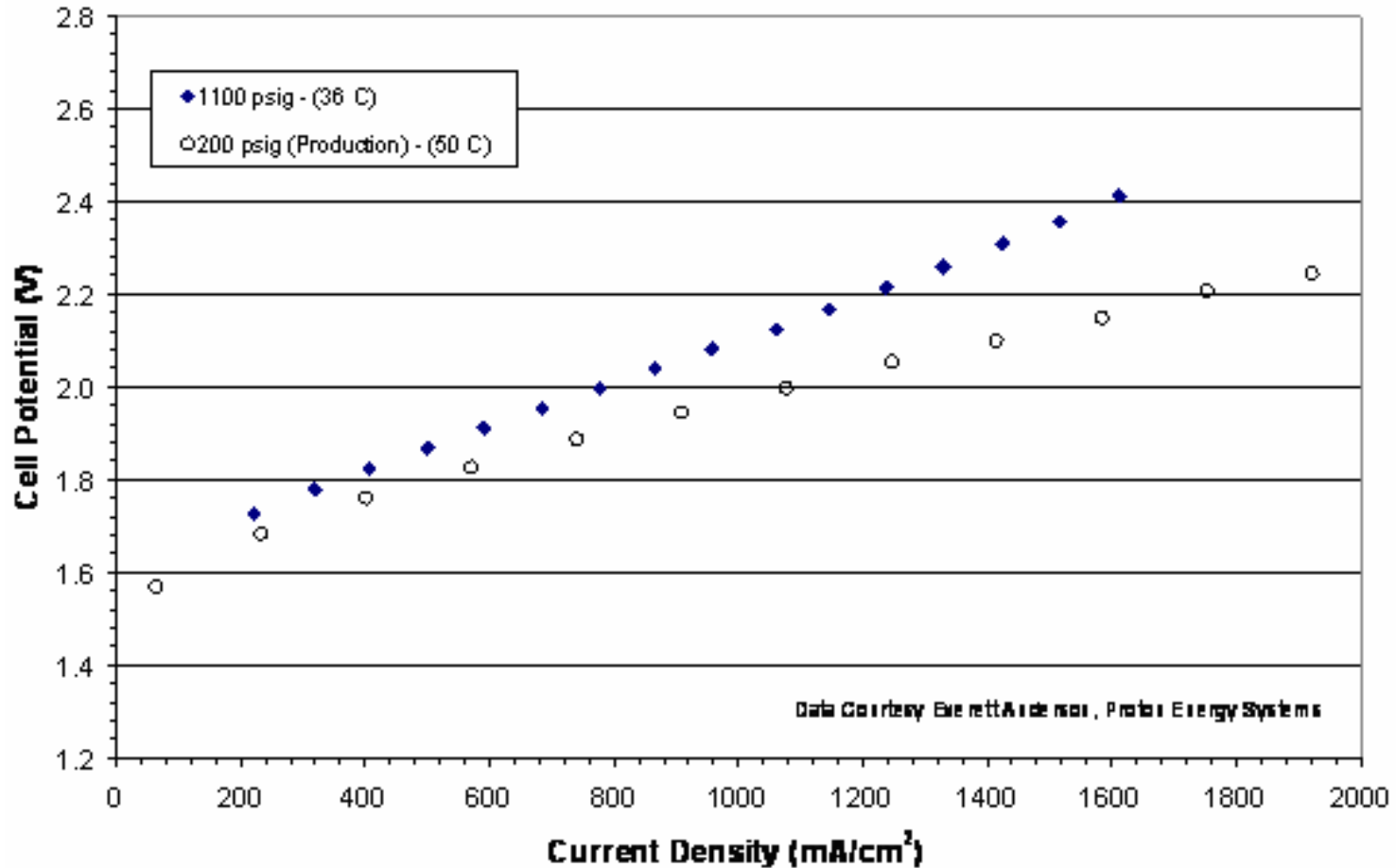



# Fuel Cell Vehicle After Conversion

Fuel cell  
Fuel Tanks  
Batteries  
Power Conversion  
& Controls

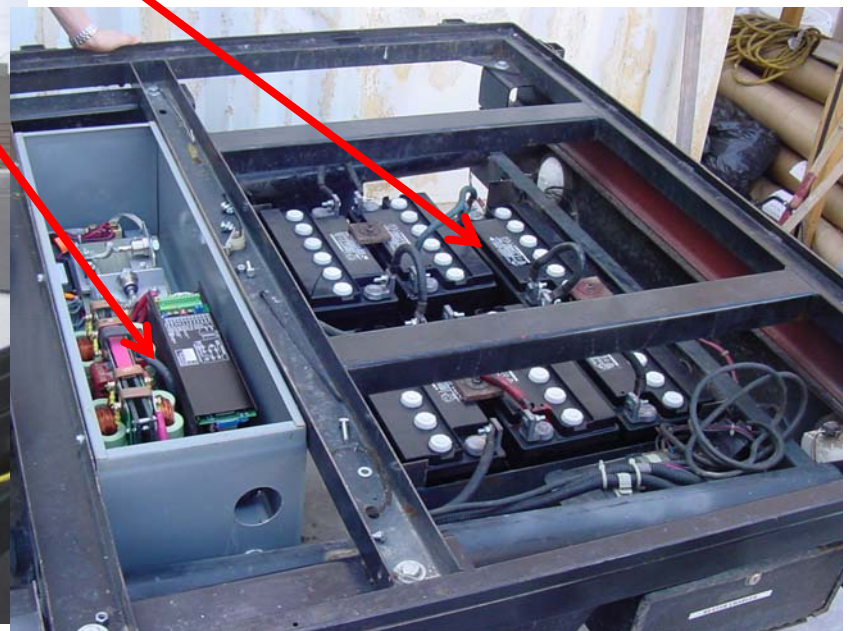
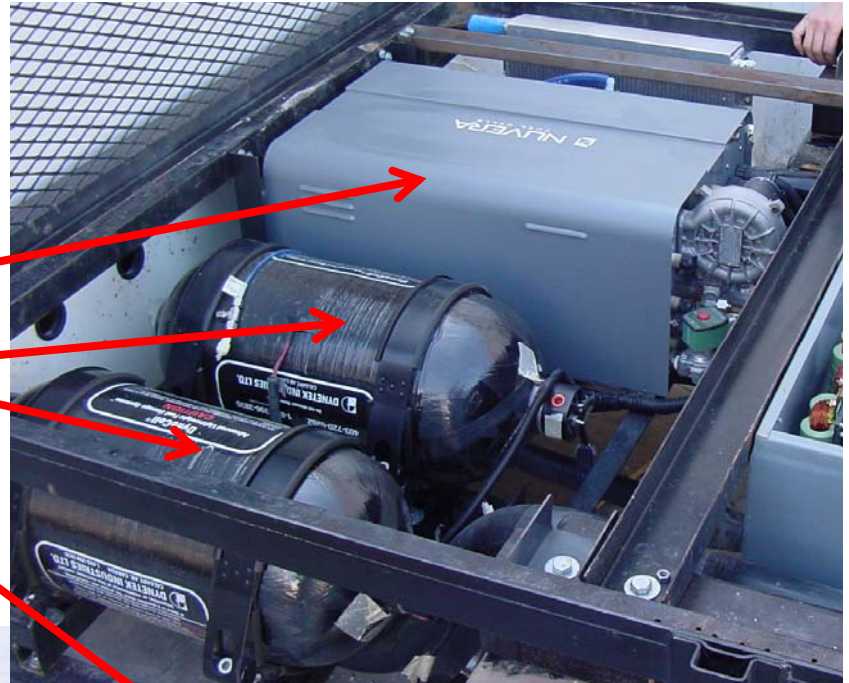



# Fuel Cell Conversion

Battery Operates in Peaking Mode

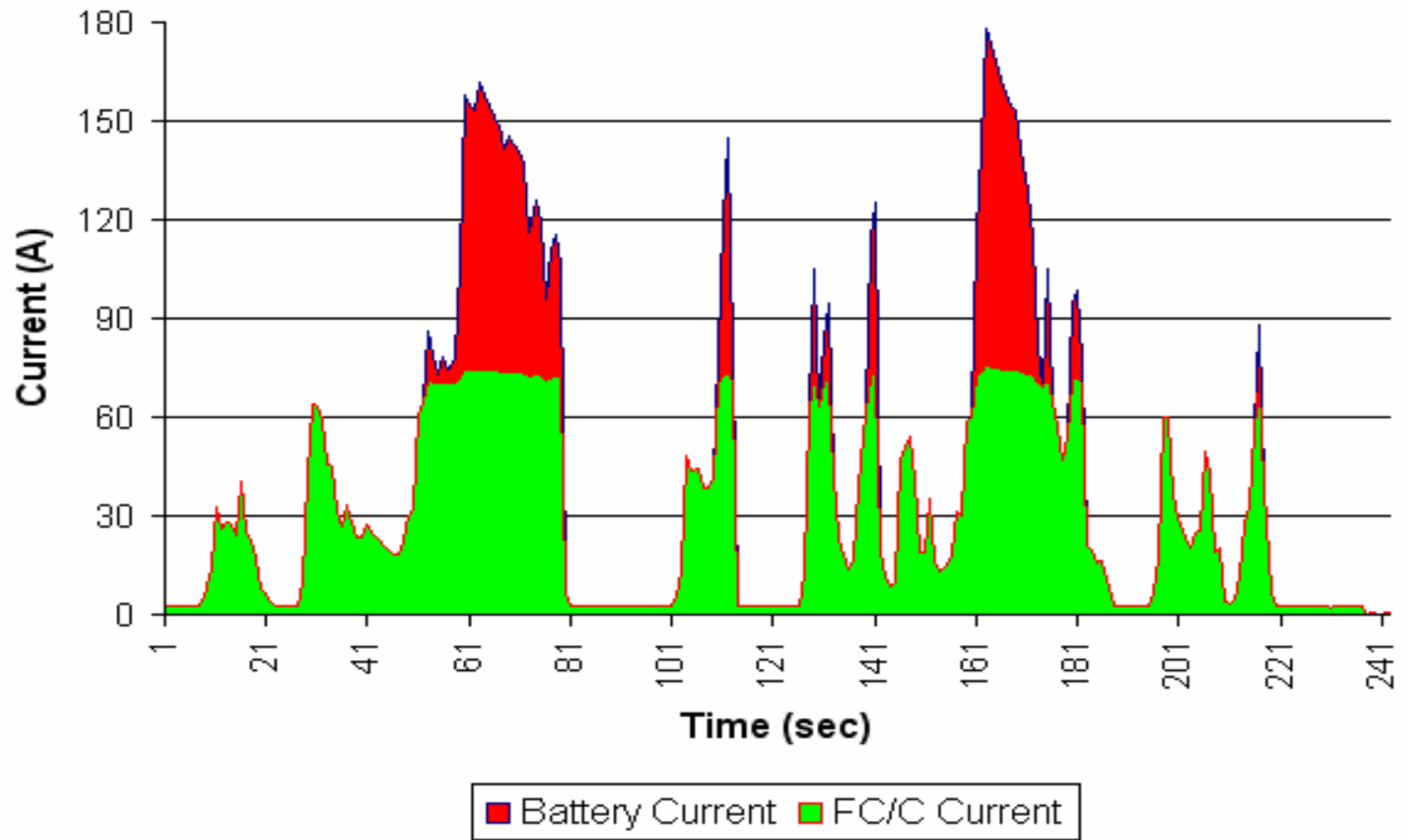

# Fuel Cell Conversion System Diagram

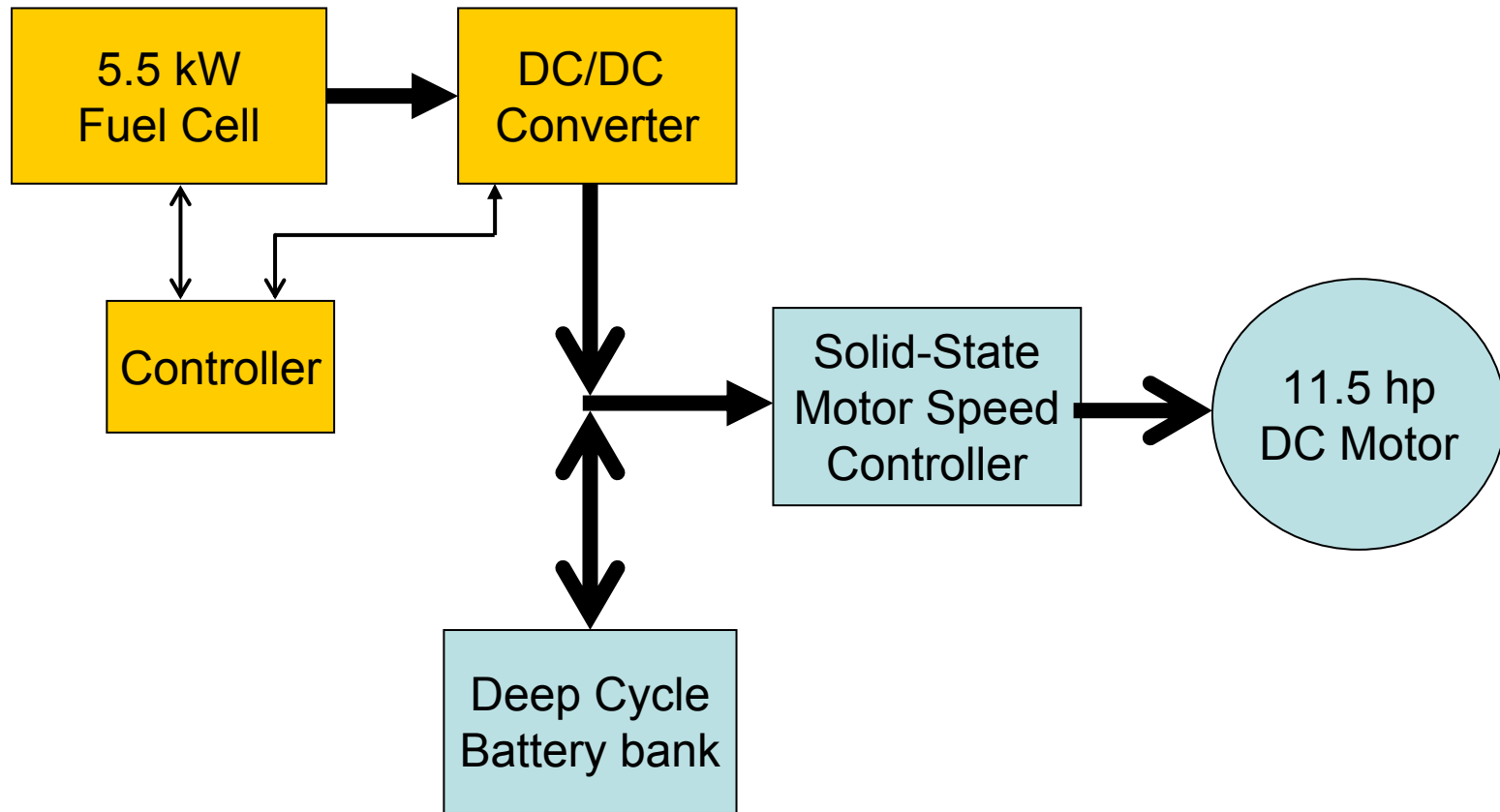

# Direct Injection ICE

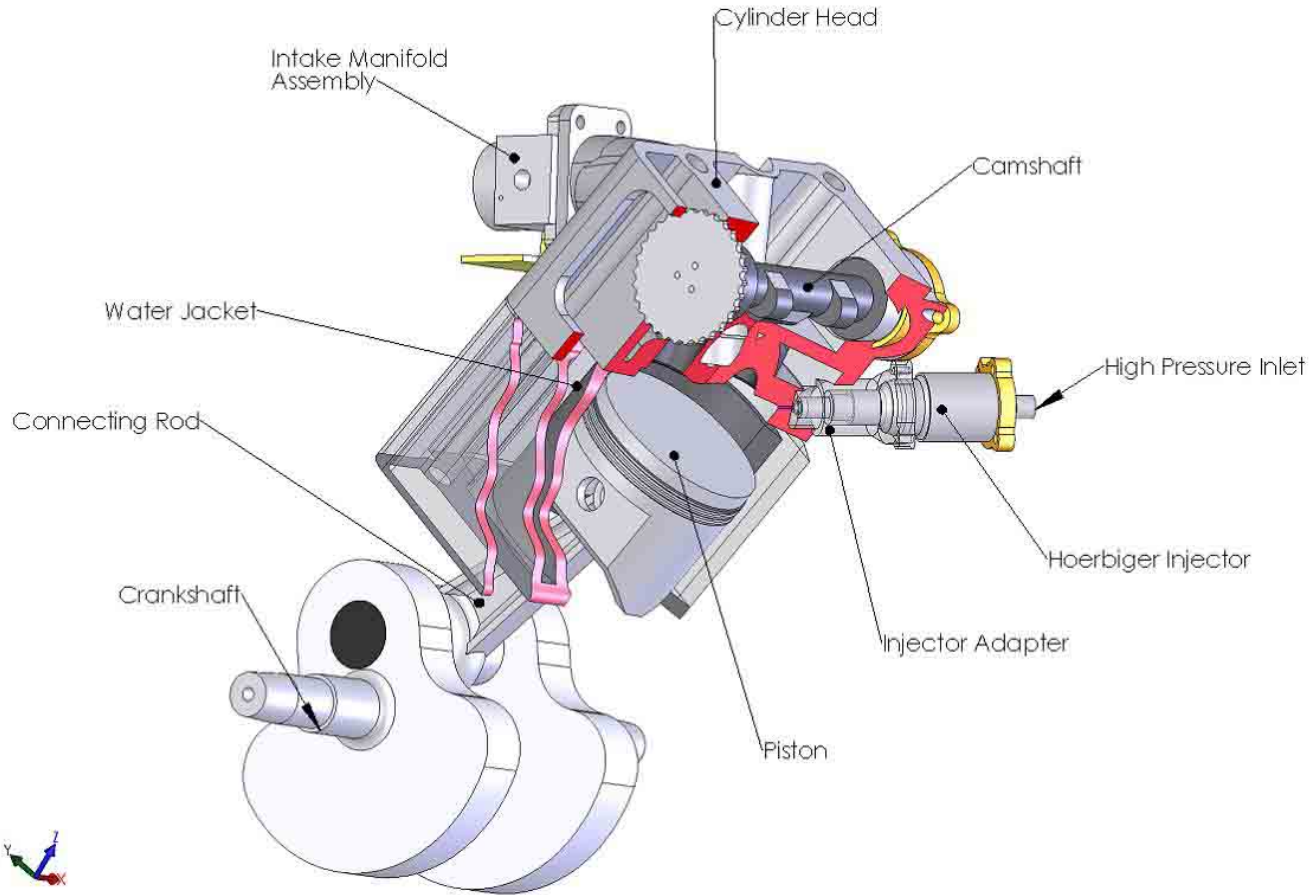

# Direct Injection ICE

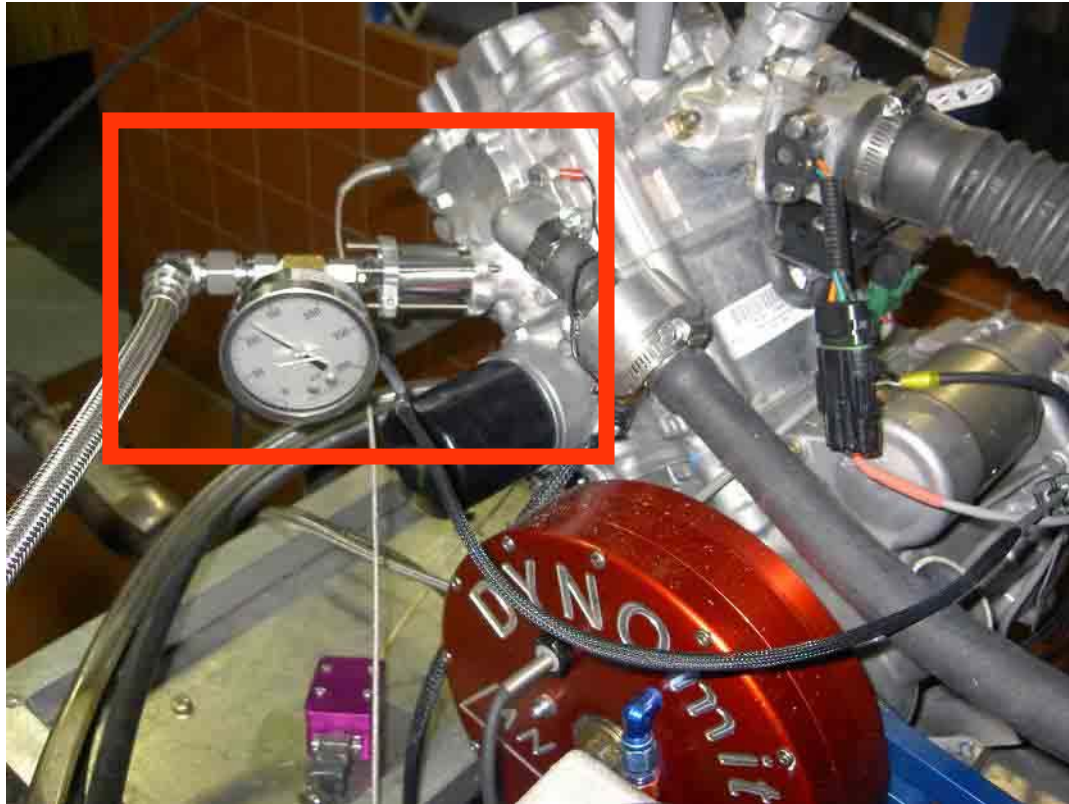

Shown is Hoerbiger direct injection unit on Polaris single cylinder engine.

# Schematic of Tandem Cell™ Experimental Setup

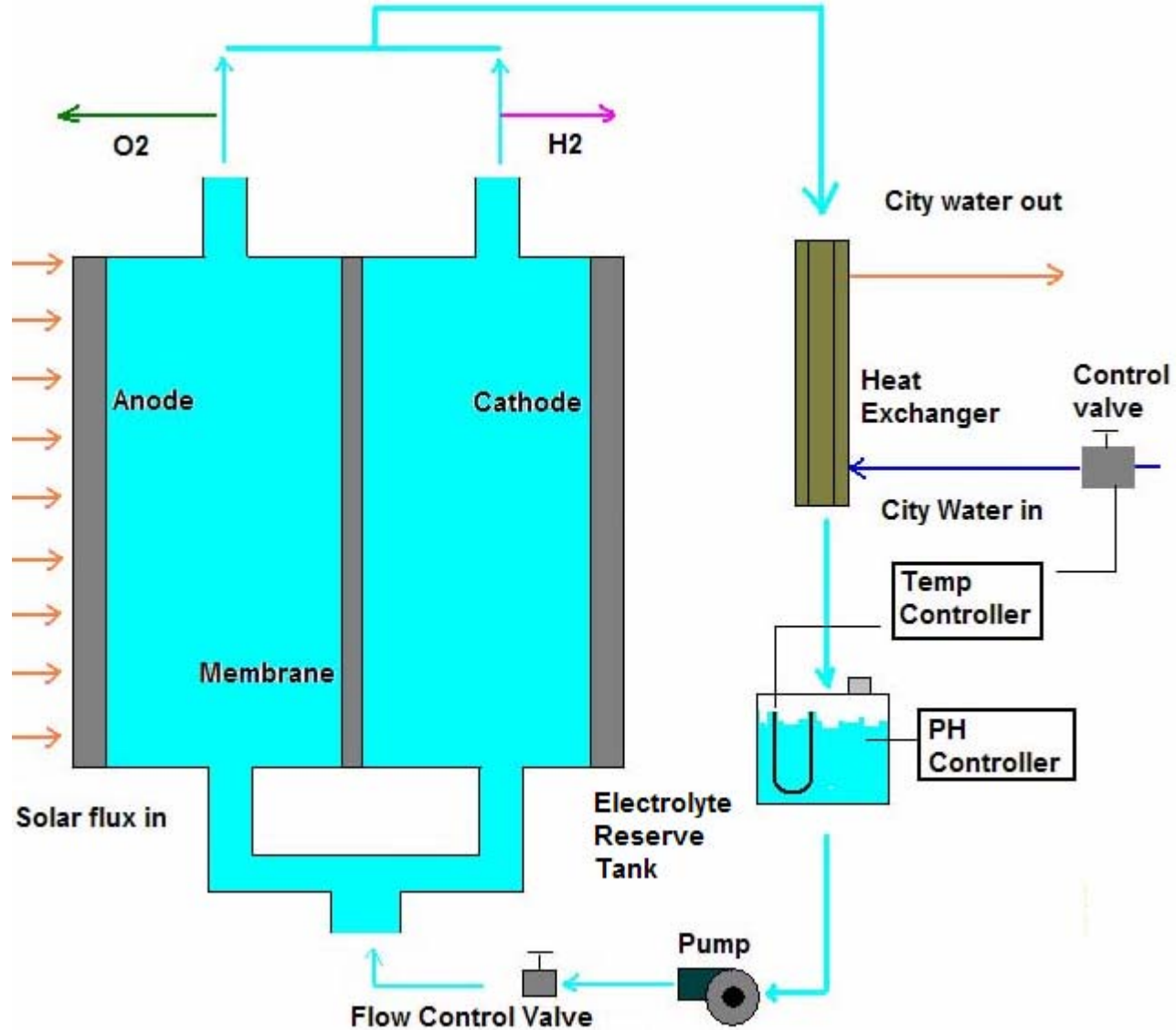

# Work in Progress-Array Testing System

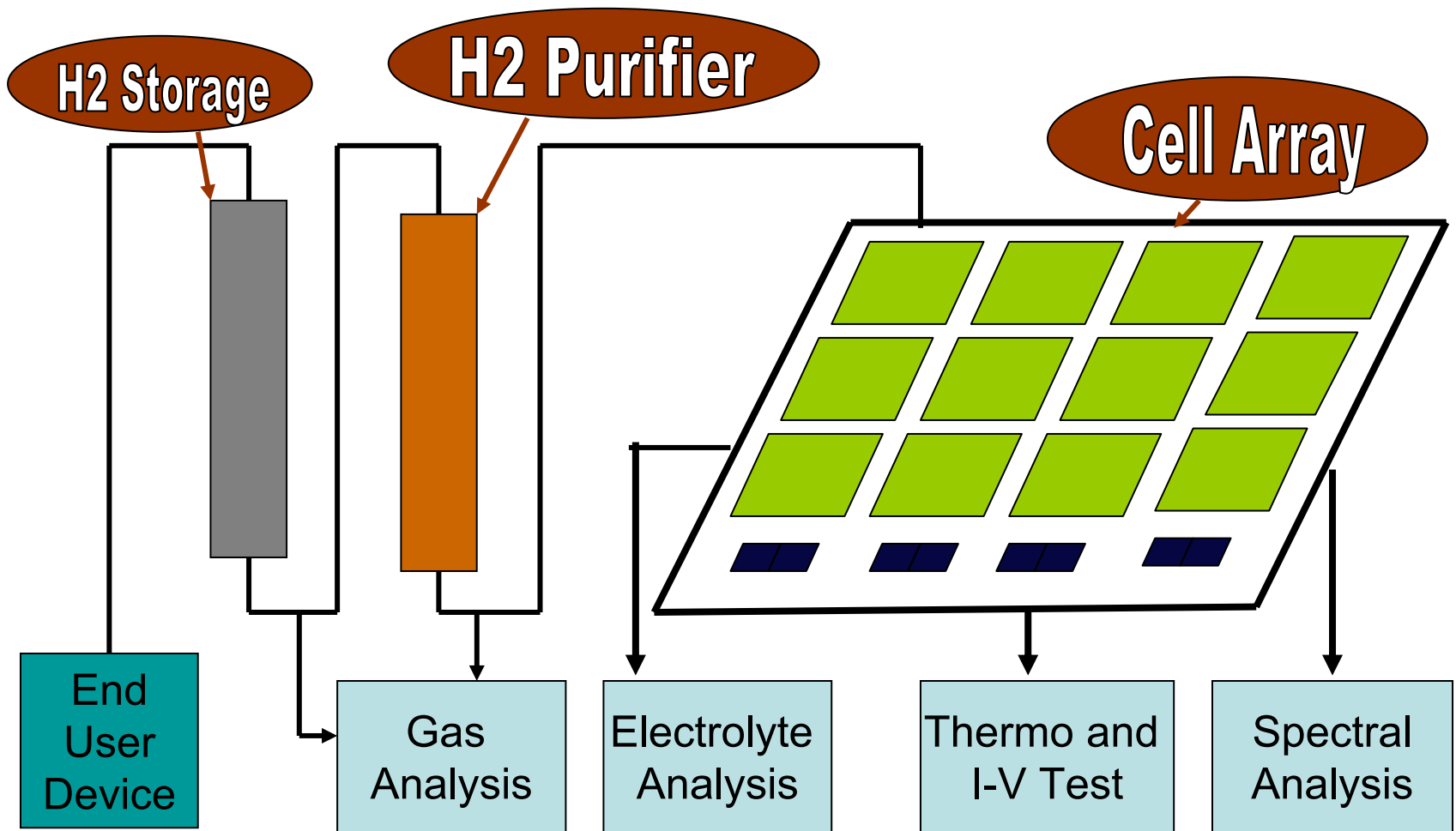

**Hydrogen Solar**

# Accomplishments-UK Operation

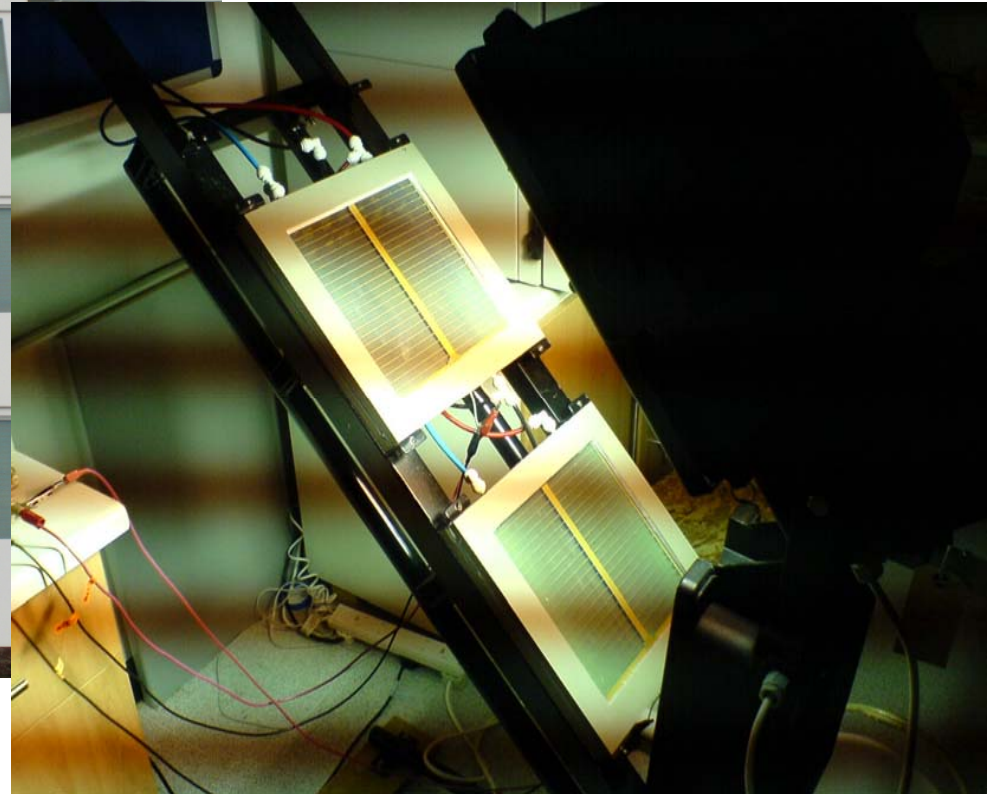
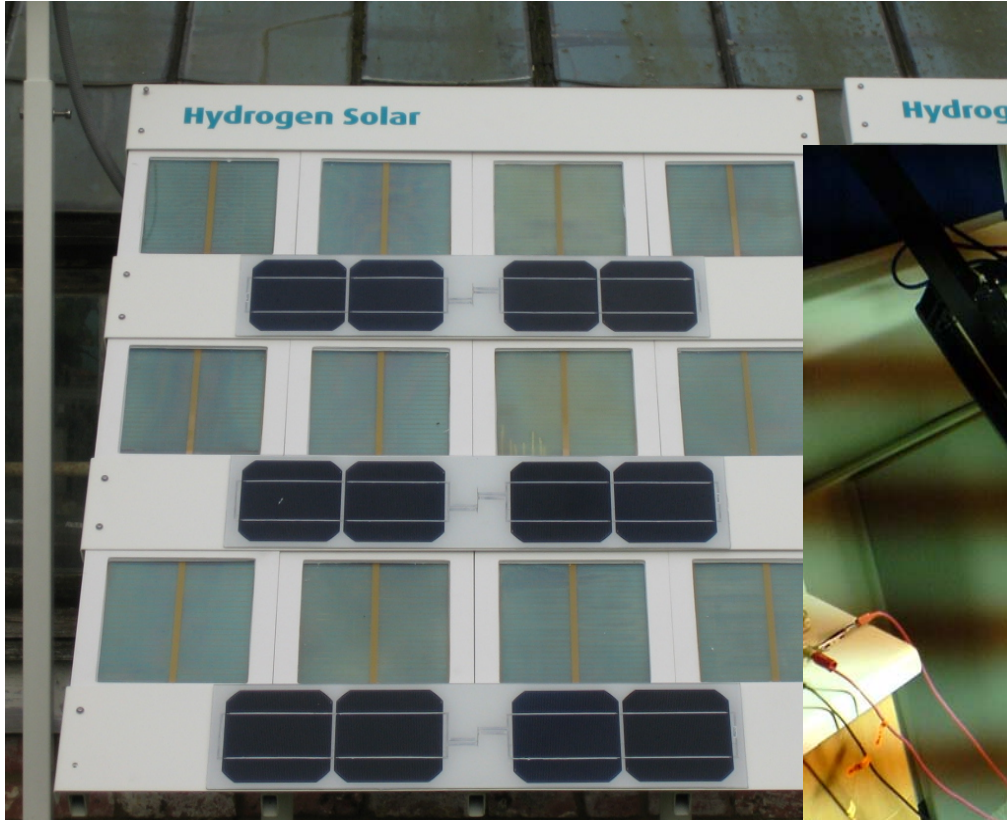

**Hydrogen Solar**



# Tandem Cell<sup>TM</sup> H<sup>+</sup> Specie Concentration Contour (mol/m<sup>3</sup>) from CFD Analysis

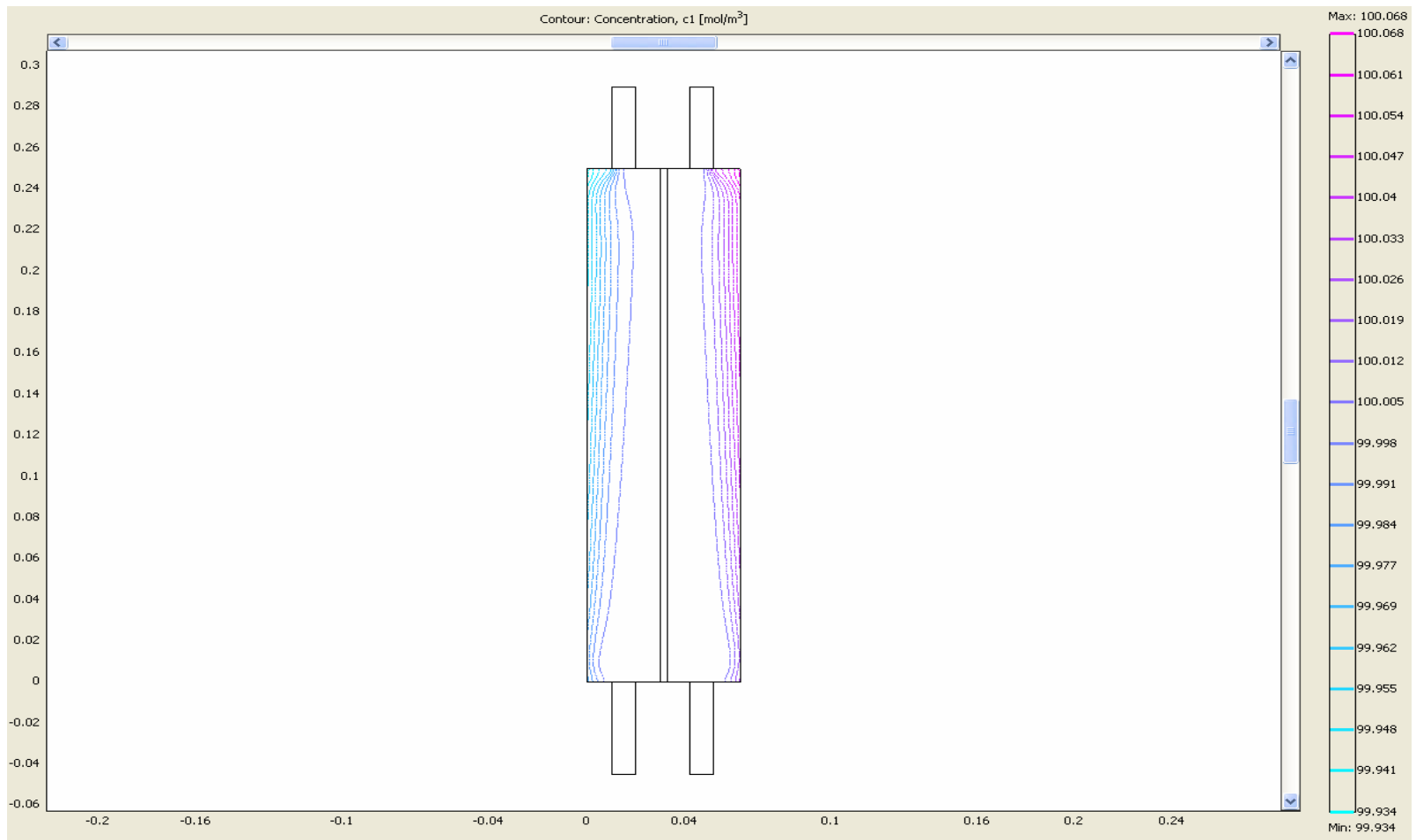



# Tandem Cell™ Velocity (m/s) Contours from CFD Analysis

