



Direct Hydrogen PEMFC Manufacturing Cost Estimation for Automotive Applications

Project ID # FC27

DOE Merit Review

May 17, 2007

Stephen Lasher
Jayanti Sinha
Yong Yang
Suresh Sriramulu

TIAX LLC
15 Acom Park
Cambridge, MA
02140-2390

Tel. 617- 498-6108
www.TIAXLLC.com

Reference: D0362

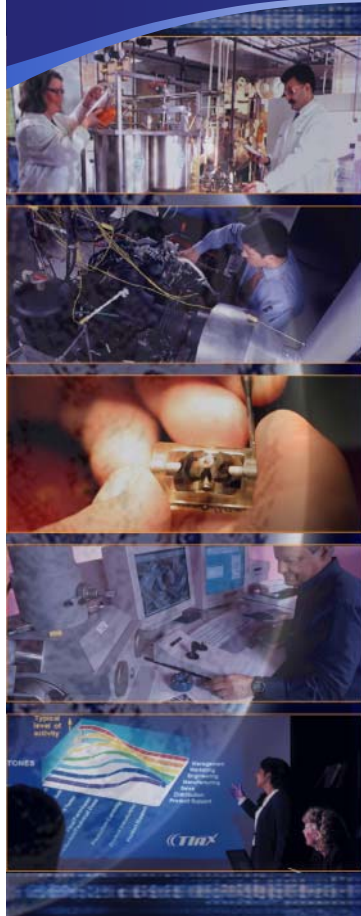

This presentation does not contain any proprietary or confidential information

Timeline

- ◆ Start date: Feb 2006
- ◆ Base period: Feb 2008
- ◆ Option period: Feb 2011

Budget

- ◆ Total project funding
 - » Base Period = \$323K
 - » With Options = \$1,484K
 - » No cost share
- ◆ FY06 = \$100K
- ◆ FY07 = \$150K

Barriers

- ◆ Barriers addressed

- » A. Cost

	Cost Targets* (\$/kW)		
	2005	2010	2015
Fuel Cell System	110	45	30
Fuel Cell Stack	70	25	15

* Manufactured at volume of 500,000 per year.

Partners

- ◆ Collaborate with ANL on system configuration and modeling
- ◆ Feedback from: Fuel Cell Tech Team, Developers, Vendors

Objectives

	Objectives
Overall	<ul style="list-style-type: none">◆ Manufacturing cost assessment of 80 kW direct-H₂ PEMFC system for automotive applications
2007	<ul style="list-style-type: none">◆ High-volume cost projection for PEMFC system using “current” performance/cost assumptions◆ Bottom-up manufacturing cost analysis for BOP components◆ Economies-of-scale impacts on the stack and BOP◆ Technology/cost breakthroughs needed for systems to meet 2010 and 2015 targets
2008–2011	<ul style="list-style-type: none">◆ Annual updates of high-volume cost projection◆ Optional: specific analysis topics including cost implications of:<ul style="list-style-type: none">» Ambient versus pressurized operation» High temperature, low humidity operation» Lower temperature, low humidity hydrocarbon membrane» Alternative PEMFC approaches including cell/stack constructions and BOP components» Other topics as the need arises

Our cost assessment addresses only the fuel cell stack and related balance-of-plant (BOP) components.

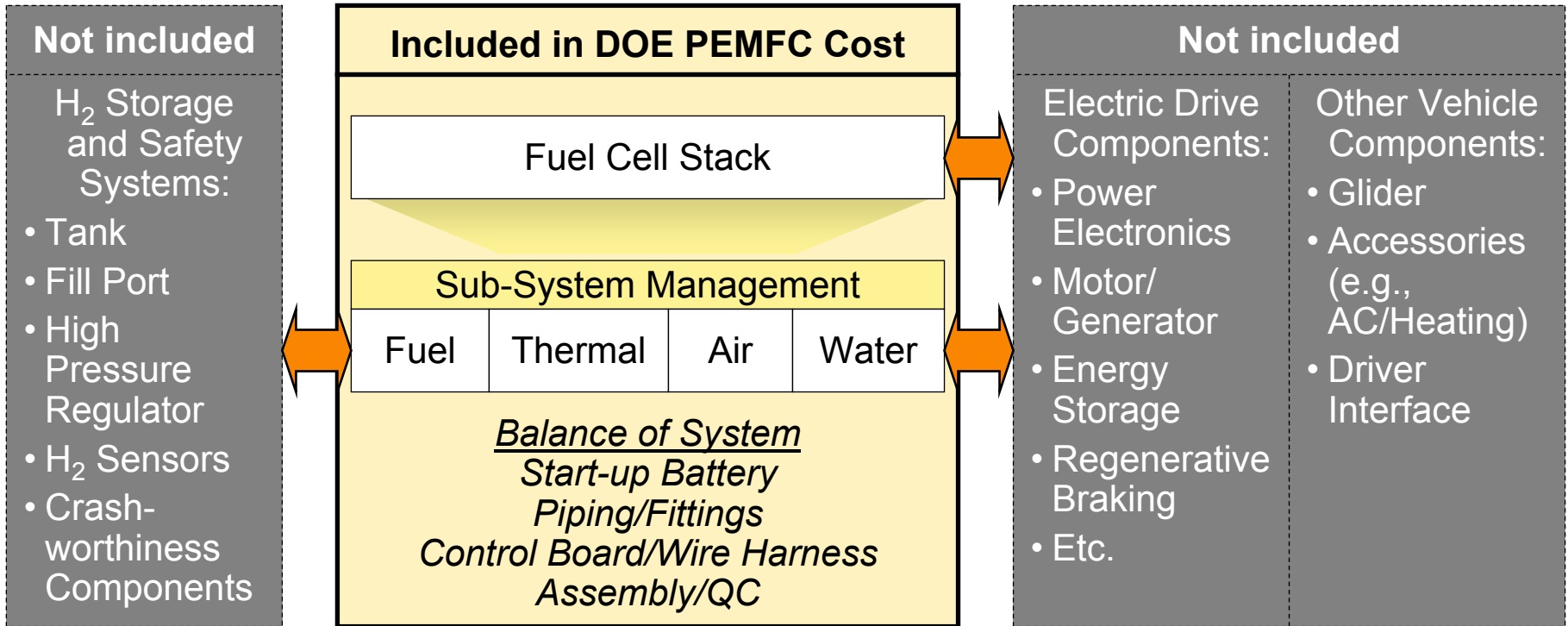

Quality Control (QC) includes leak and voltage tests, but does not include stack conditioning.

Approach Overall Cost Assessment

Manufacturing cost estimation involves technology assessment, cost modeling, and industry input to vet assumptions and results.

Technology Assessment

- Perform Literature Search
- Outline Assumptions
- Develop System Requirements and Design Assumptions
- Obtain Developer Input

Cost Model and Estimates

- Develop BOM
- Specify Manufacturing Processes and Equipment
- Determine Material and Processing Costs
- Develop Bulk Cost Assumptions

Overall Model Refinement

- Obtain Developer and Industry Feedback
- Revise Assumptions and Model Inputs
- Perform Sensitivity Analyses

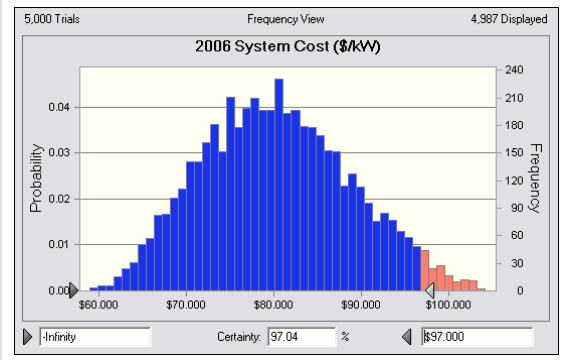
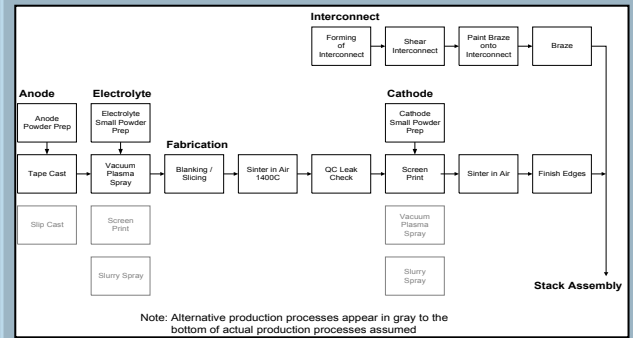
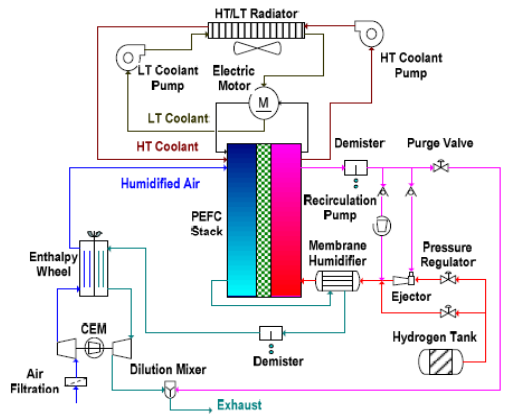

BOM – Bill of Materials

We are working with Argonne National Laboratory (ANL) to define the 2007 system configuration, performance and component specifications.

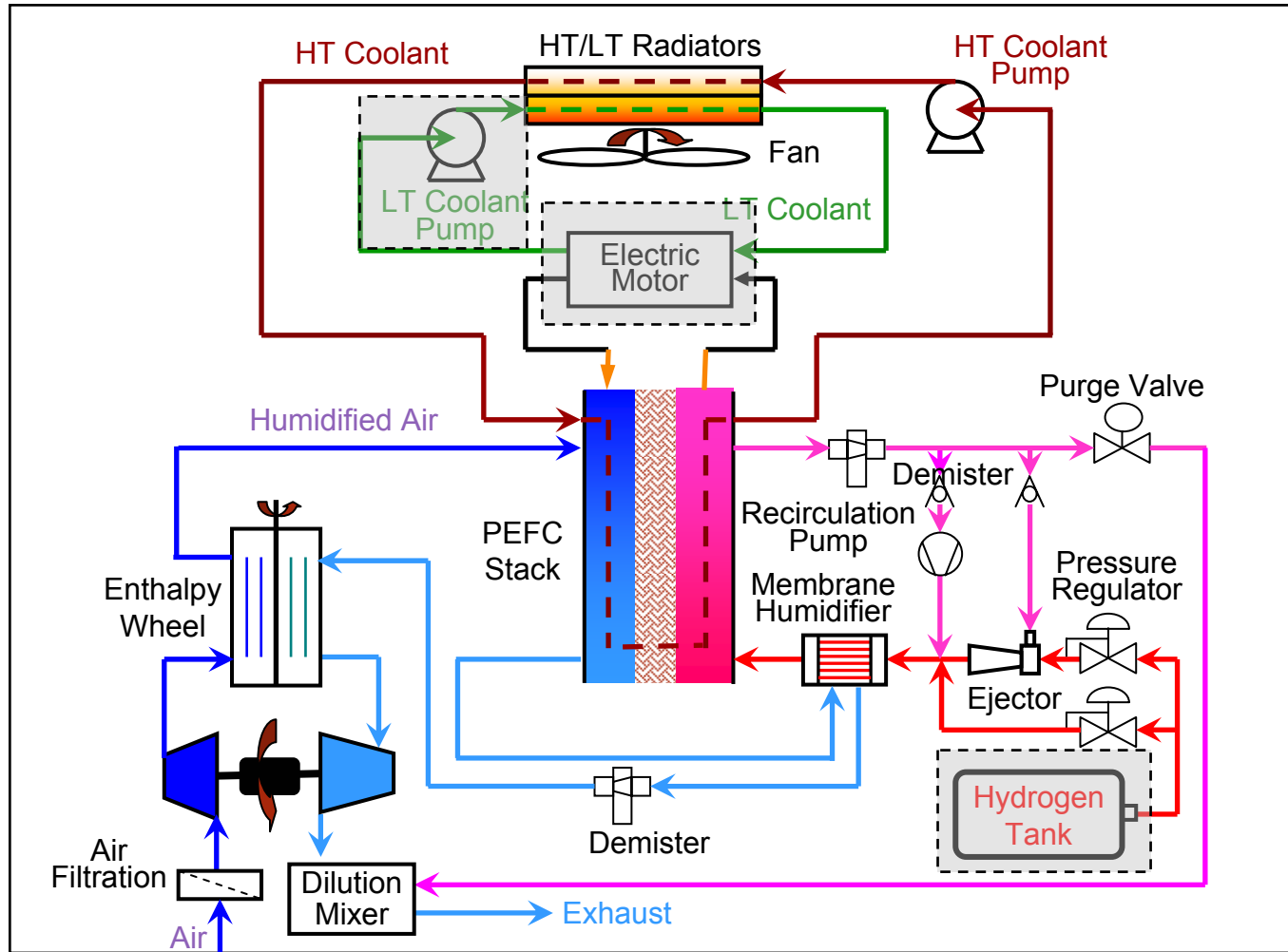

Not included in the fuel cell system cost assessment

Reference: R.K. Ahluwalia and X. Wang, Reference Fuel Cell System Configurations for 2007: Interim Results, ANL, Feb. 6, 2007

We primarily use a bottom-up approach to determine manufacturing cost and the impact of economies-of-scale (i.e., production volumes).

Stack Components

- Catalyst Coated Membrane
- Electrodes
- Gas Diffusion Layer (GDL)
- Membrane Electrode Assembly (MEA)
- Bipolar Plates
- Seals/Gaskets

- » **Develop production process options for key subsystems and components**
- » **Obtain raw material prices from potential suppliers**
- » **Estimate manufacturing costs using capital equipment and raw material costs, and labor rates**

BOP Components

- Radiator
- Membrane Humidifier
- Enthalpy Wheel Humidifier
- Compressor/Expander/Motor (CEM)
- H₂ Recirculation Pump
- H₂ Ejector

- » **Develop Bill of Materials (BOM)**
- » **Obtain raw material prices from potential suppliers**
- » **Estimate manufacturing costs using TIAX cost models and Boothroyd Dewhurst Design for Manufacturing (DFM®) software**

We estimate an automotive OEM factory cost, excluding OEM corporate charges for profit, sales and G&A expenses.

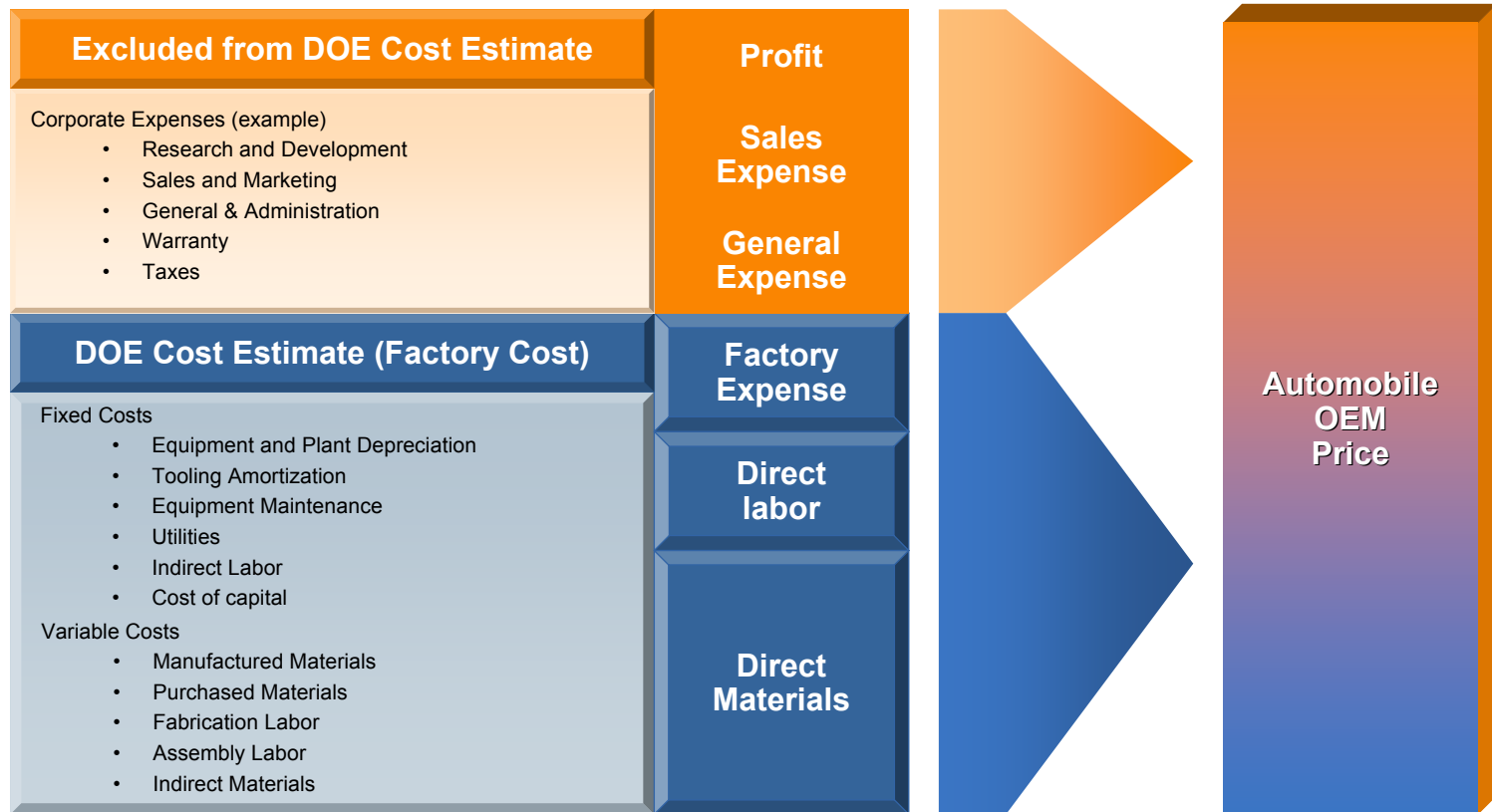

- We assume a vertically integrated process for the manufacture of the stack, so no mark-up is included on those components
- Raw materials and BOP components are assumed to be purchased by the OEM and therefore include supplier mark-ups

Approach Stack Costing

Our PEM stack cost model integrates expertise in materials, design, and manufacturing operations.

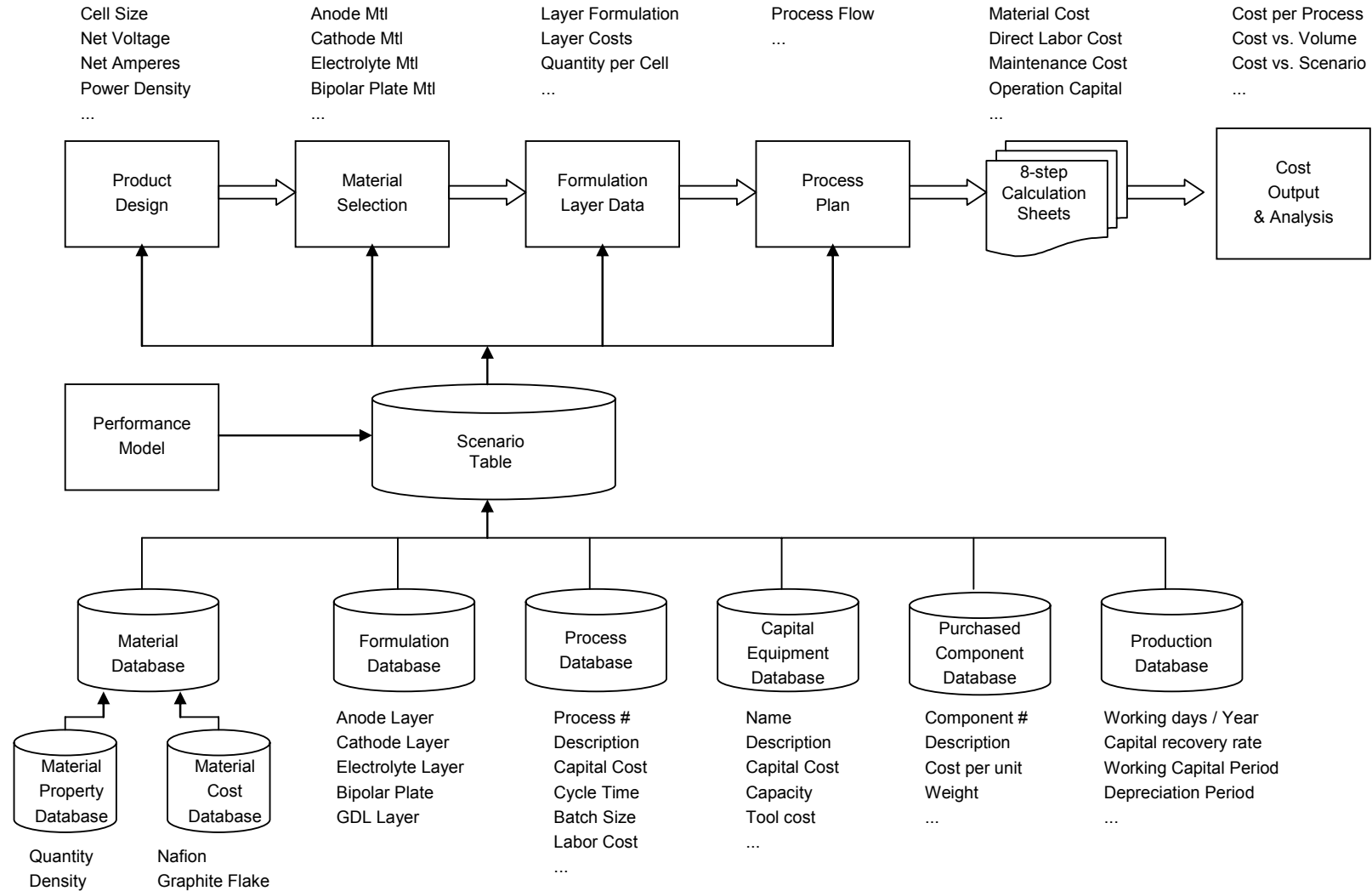

Patents, white papers and personal communications are used to determine the BOM and other inputs for cost estimation.

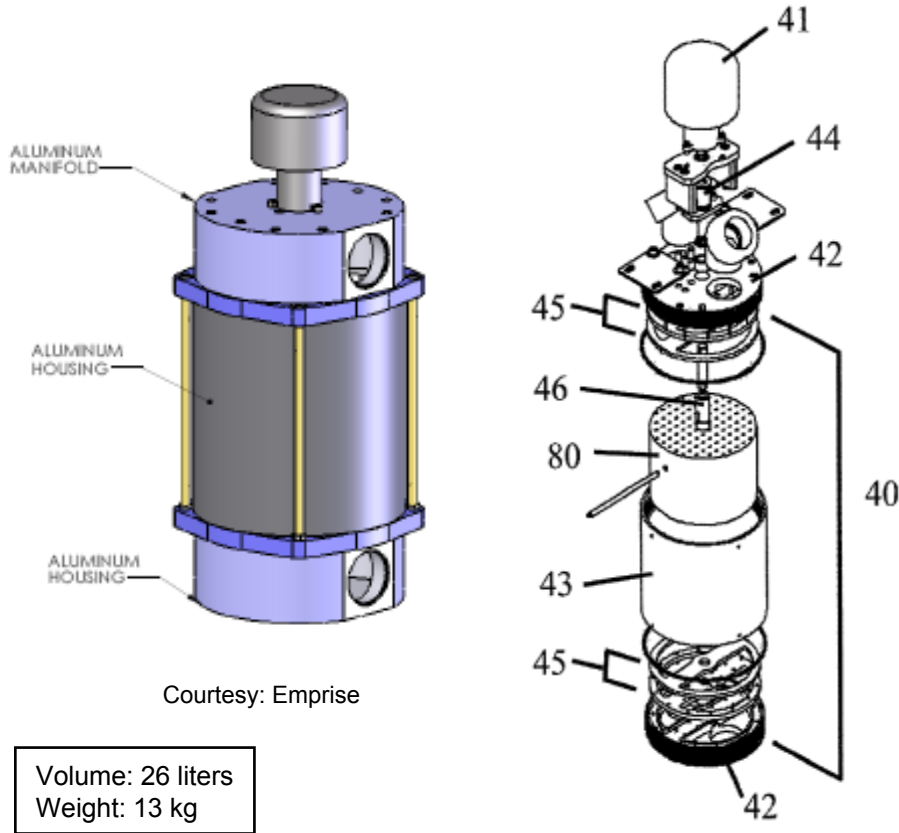

Courtesy: Emprise

US Patent 2002/0071979

Enthalpy Wheel Humidifier			
Component	#	Material	Size
DC motor with gear box	1	Misc.	Φ4" x 4 3/4"
Shaft	2	Steel	Φ 3/8" x 3"
Wheel shaft	2	Steel	OD:Φ1/2", ID:Φ 3/8", L1"
Bearing	2	Misc.	ID Φ3/8"
End plate	2	Teflon	Φ7 1/4" x 1/4"
Spring plate	2	Steel	Φ7 1/4" x 1/8"
End seal plate	2	Teflon	Φ7 1/4" x 1/4"
Core	1	Cordierite	Φ7 1/4" x 9"
Core pin	1	Steel	Φ7 " x 1/4"
Manifold (motor side)	1	Al	Φ8 1/2" x 7"
Bolts	24	Misc.	Φ1/4" x 3 1/2"
Main housing	1	Al	Φ7 3/4" x 10"
Bolts	4	Misc.	Φ3/8" x 10 1/2"
Base manifold	1	Al	Φ8 1/2" x 7 "

With the exception of heat exchangers, the BOP components have not been made at high volumes.

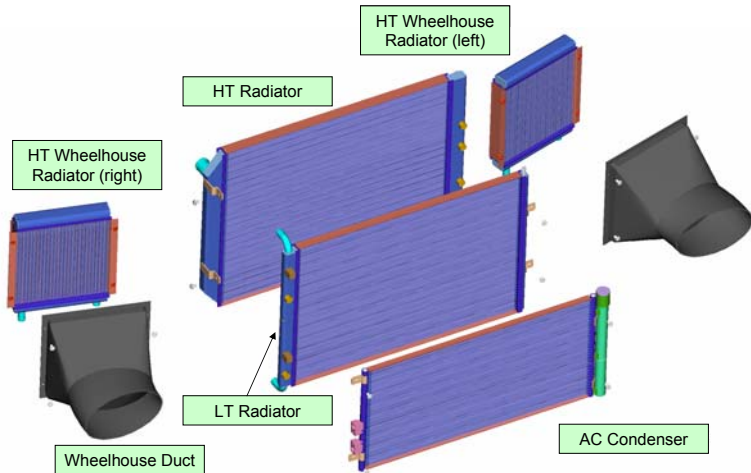

Radiator - Modine



CEM - Honeywell

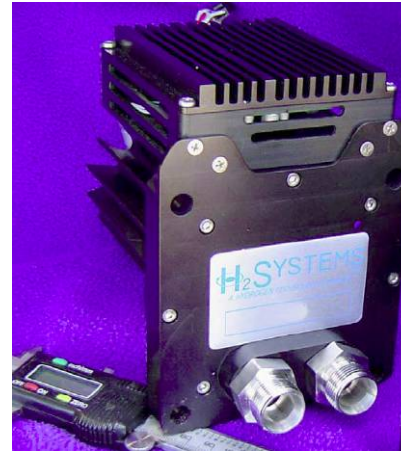

H₂ Recirc. Pump - H₂ Systems

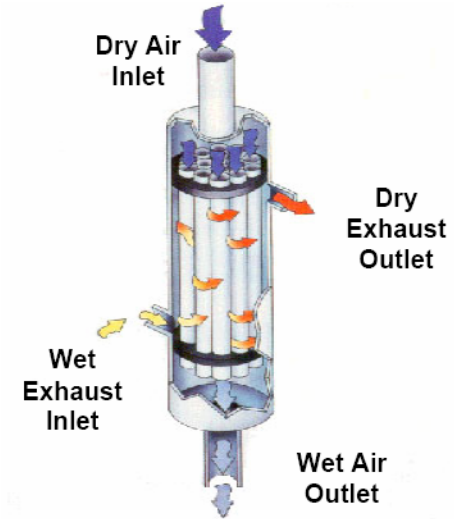

Membrane Humidifier - Perma Pure LLC

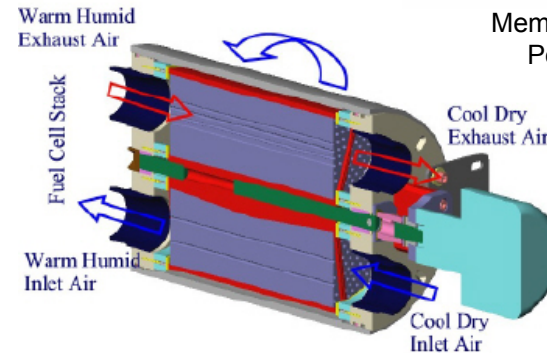

Enthalpy Wheel - Emprise Corp.

Technology advances such as high temperature membranes could simplify and reduce the size/cost of some of the BOP components.

To date, we have developed preliminary bottom-up costs for the 2007 stack configuration and some BOP components.

2007 Objectives and Status

- High-volume cost projection for PEMFC system using “current” performance/ cost assumptions
 - 2006 Stack Update = complete (see Backup Slides)
 - 2007 System Update = preliminary results
- Bottom-up manufacturing cost analysis for BOP components = preliminary results for radiator, membrane humidifier and enthalpy wheel
- Economies-of-scale impacts
 - 2006 Stack = preliminary results (see Backup Slides)
 - 2007 BOP = work in progress
- Technology/cost breakthroughs needed for systems to meet 2010 and 2015 targets = work in progress

Stack performance assumptions were provided by ANL based on their modeling of a 3M-like stack.

- Improvement over 2005 assumptions:
 - 60% reduction in Pt loading with an increase in power density
 - 40% thinner and less expensive membrane on an area basis
- Platinum (Pt) loading and power density are critical parameters that influence stack cost
- Lower Pt loading is attributed to novel catalyst alloy and structure (i.e., nano-structured thin film)
- We did not perform a due diligence or review the performance assumptions with multiple developers (to date)

Performance Assumptions		2005	2007 ¹
Net power	kW _e	80	80
Gross power	kW _e	89.5	86.4
Power density	mW/cm ²	600	753
Cell voltage	V	0.65	0.68
Pt loading (total)	mg/cm ²	0.75	0.30
Membrane thickness	μm	50	30
Stack Temp.	°C	80	90
Pressure (rated power)	atm	2.5	2.5
Stack eff. (rated power)	% LHV	52	54

¹ Reference: R.K. Ahluwalia and X. Wang, Reference Fuel Cell System Configurations for 2007: Interim Results, ANL, Feb. 6, 2007

Key assumptions in 2007 represent stack performance breakthroughs, in particular high power density with significant Pt reduction.



To be consistent with the 3M-like stack design, we made the following material assumptions for the cost projection.

Component	Parameter	Selection
Membrane	Material	3M PFSA (EW=825)
	Supported	No
Electrodes (Cathode and Anode)	Catalyst	Ternary PtCo _x Mn _y alloy (Pt/TM = 3)
	Type	Nano-Structured Thin Film
	Supported	Organic whiskers
Gas Diffusion Layer (GDL)	Material	Woven carbon fiber
	Porosity	70%
Bipolar Plate	Type	Expanded graphite foil
Seal	Material	Viton®

The major differences from the 2005 material assumptions lie in the catalyst composition/structure and the use of Viton® as a sealant.



We completed preliminary bottom-up costing for the enthalpy wheel, membrane humidifier and radiator (to date).

BOP Sub-system	Technology	Source	OEM Price ¹ (\$/kW)	Comments
Water	Enthalpy wheel air-humidifier	Emprise	3.14	Preliminary result (2005 estimate = \$3.25/kW)
	Membrane H ₂ -humidifier	PermaPure	2.00	Preliminary result (2005 estimate = \$4.75/kW)
Thermal	Automotive tube-fin radiator	Modine	1.28	Preliminary result (2005 estimate for radiator and fan = \$2.75/kW)
	Radiator fan	TIAX	0.63	Assumes ² \$50/unit
	Coolant pump	TIAX	1.50	Based on 2005 estimate ²
Air	Compressor-Expander-Motor	Honeywell	13.5	Based on 2005 estimate ² : \$8.75/kW for turbo-machinery, motor & controller only, not including labor, testing, or CapEx; for 100,000 units/year
Fuel	H ₂ recirc. pump	H ₂ Systems	3.75	Based on 2005 estimate ²
	H ₂ ejector	Croll-Reynolds, Elmridge	0.50	Based on 2005 estimate ²

¹ Preliminary results based on factory cost plus supplier mark-up for an 80 kW net power PEMFC system. Does not represent how costs would scale with power (kW). Estimates are not accurate to the number of significant figures shown.

² We will determine the new bottom-up costing later this year.



Stack costs on a per kW basis are 54% lower than the 2005 costs primarily due to higher power density with decreased Pt loading.

Cost ¹ , \$/kW	2005	2007	% change ²	2010 DOE Target	Cost drivers / Comments
Membrane	4	2	-46%	10	Power density increased from 600 mW/cm ² to 753 mW/cm ² Pt loading decreased from 0.75 mg/cm ² to 0.3 mg/cm ²
Electrode	52	18	-66%		
GDL	3	2	-42%		
Bipolar plate with cooling	3	3	-17%		Membrane thickness decreased 40% Woven carbon fiber cost decreased from \$30/kg to \$20/kg
Seal	1	2	73%		Changed window frame from nitrile rubber (\$5/lb) to Viton® (\$20/lb)
BOS	1	1	-13%		Includes stack manifold, bolts, end plates, current collector
Final Assembly	2	3	75%		2007 cost includes QC but not conditioning, while 2005 cost includes neither
Total²	67	31	- 54%	25	

¹ Factory cost for an 80 kW net power PEMFC system. Does not represent how costs would scale with power (kW).

² Results may not appear to calculate due to rounding of the 2005 and 2007 cost results.

The electrodes represent approximately 57% of the \$31/kW fuel cell stack cost in 2007.

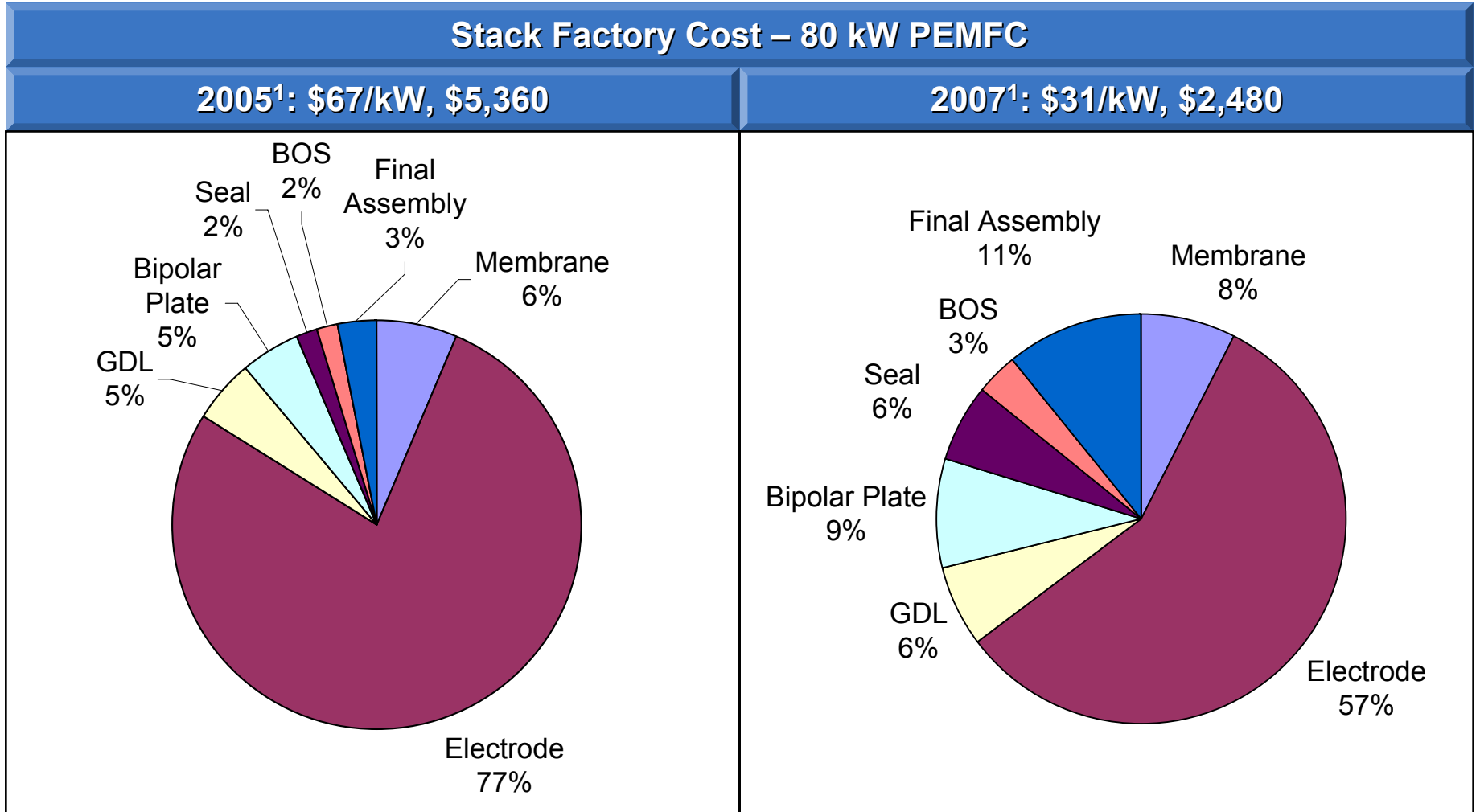

¹ Factory cost for an 80 kW net power PEMFC system. Does not represent how costs would scale with power (kW).



BOS – Balance-of-Stack

Preliminary Results System Cost Breakout

With the much reduced stack cost, BOP components make up a much larger fraction of the overall system cost.

Cost ¹ , \$/kW	2005	2007
Stack	67	31
Water Mgmt.	8	5
Thermal Mgmt.	4	3
Air Mgmt.	14	14
Fuel Mgmt.	4	4
Misc.	7	5
Assembly	4	5
Total	108	67

¹ Preliminary results for factory cost for an 80 kW net power PEMFC system. Does not represent how costs would scale with power (kW).

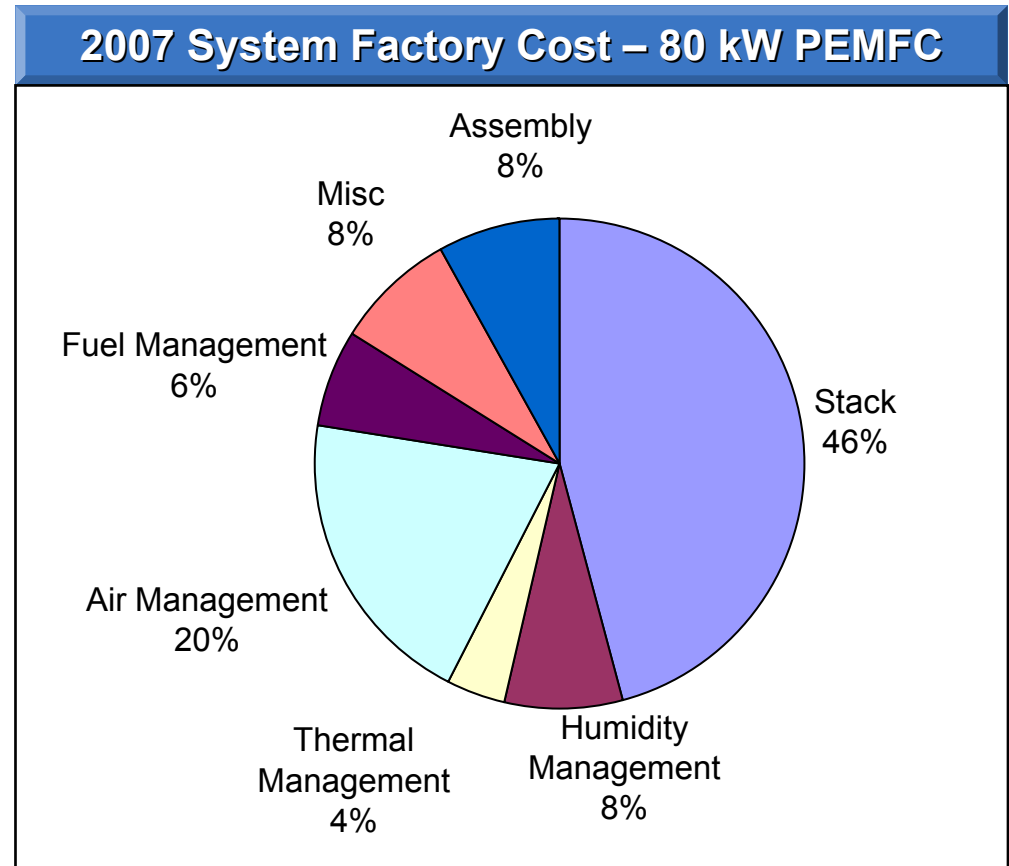

We used 2005 estimates for the air and fuel management; these will be updated with bottom-up costing later this year.



Preliminary Results Comparison to Targets

While our focus is on cost, the system must ultimately satisfy efficiency, life, and power density requirements.

Subsystem	Volume ¹ (L)	Weight (kg)	Cost (\$/kW)	DOE 2010 Target ²
Stack	40	47	31	\$25/kW
Power density (W_e/L)	2,000			2,000
Specific power (W_e/kg)	1,702			2,000
Balance of Plant	130	80	37	
Water management (enthalpy wheel, membrane humidifier)	38	17	5	
Thermal management (radiator, fan, coolant pump)	53	19	3	
Air management (CEM)	15	17.5	14	\$5/kW
Fuel management (pump, ejector)	5.1	6.2	4	
Miscellaneous and assembly	19	21	10	
Total	170	127	67	\$45/kW
Power density (W_e/L)	471			650
Specific power (W_e/kg)	630			650

PRELIMINARY



¹ Does not include packing factor, which would lower volumetric power density.

² FreedomCAR targets, \$20/kW for the stack and \$35/kW for the total system, are different from DOE targets.

Next Steps

We will complete the bottom-up costing of the remaining BOP components and obtain industry feedback on our assumptions/results.

- Complete bottom-up manufacturing cost assessment for all major BOP components, e.g., air management (CEM) and fuel management (H₂ recirculation pump/ejector)
- Perform economies of scale analysis for BOP components assuming 100, 30K, 80K, 130K and 500K units per year
- Interview developers and stakeholders for feedback on performance and cost assumptions and overall results
 - 2006 Stack economies-of-scale
 - 2007 BOP economies-of-scale
 - 2007 System high-volume cost
- Incorporate feedback into cost analysis and perform sensitivity analyses
- Perform cost analysis of PEMFC system meeting 2010 and 2015 performance targets
- Identify technology barriers to meeting cost targets, and catalog ongoing or required research to surmount these barriers

Thank You

Questions?

We coordinated with DOE, ANL, developers, and stakeholders was since the last Merit Review.

Audience/ Reviewer	Date	Location
DOE Merit Review	May 06	Washington DC
Kickoff Mtg. with DOE	May 06	Washington DC
Coordination Mtg. with DOE and ANL	Oct 06	Washington DC
Fuel Cell Tech Team Mtg.	Aug 06	Detroit MI
Manufacturing Process Review Mtg. with 3M	Mar 07	Telecon
Fuel Cell Tech Team Mtg.	Apr 07	Detroit MI
Several Work-in-Progress Mtgs. with DOE and ANL	06-07	Telecon

We developed material costs and additional stack specifications consistent with the performance and design assumptions.

TIAX Assumptions	Units	2005	2007
Production volume	units/yr	500,000	500,000
Pt cost	\$/g (\$/troz)	29.0 (900)	35.4 (1100)
PFSA ionomer cost	\$/lb	80	80
Woven carbon cloth cost	\$/lb	14	9
Seal material cost	\$/lb	5	20
Graphite flake cost	\$/lb	2	2
Number of stacks		2	2
Number of cells per stack		231	221
Stack voltage (rated power)	V	300	300
Active area per cell	cm ²	323	260
% Active area	%	85	85
Cell pitch	cells/inch (cells/cm)	9.55 (3.76)	10.00 (3.85)

Most 2007 assumptions are consistent with 2005, except an increase in Pt cost to reflect current (high) prices.



Platinum at 1100 \$/troz is in the mid to low end of the range for 2006, but much higher than historic prices.

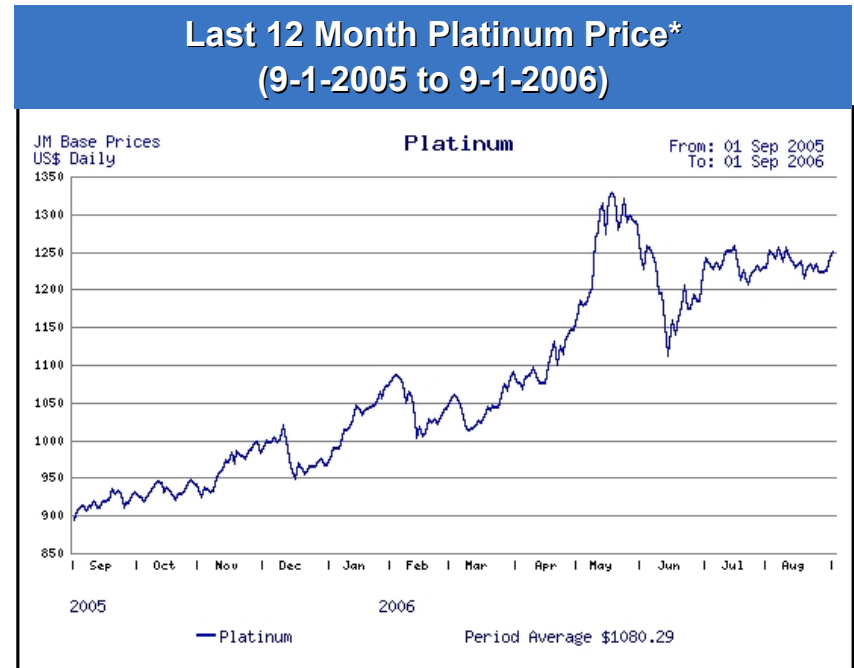
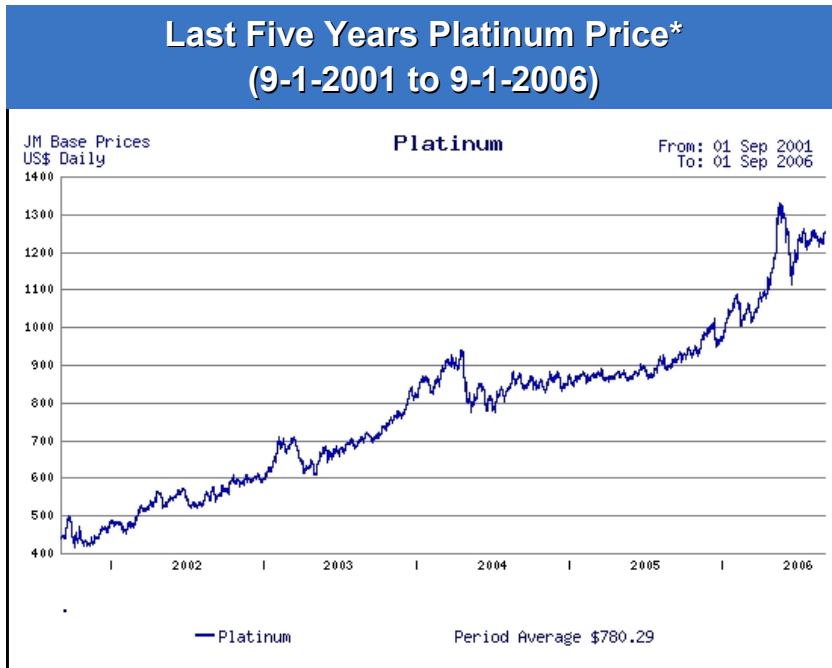

* Platinum price data comes from Johnson Matthey website.

The cost of operating capital and non-operating capital are included in our processing cost estimates.

- Variable Cost Elements
 - Material
 - Direct Labor
 - Utility
- Operating Fixed Costs
 - Tooling & Fixtures
 - Maintenance
 - Overhead Labor
 - Cost of Operating Capital
- Non-Operating Fixed Costs
 - Equipment
 - Building
 - Cost of Non-Operating Capital

- Working Capital
 - Including materials, labor, utility, tooling and maintenance cost
 - Working capital period: 3 months

- Equipment
- Building

We assume 100% debt financed with an annual interest rate of 15%, 10-year equipment life, and 25-year building life.



Material costs dominate the factory cost of the stack components. For example, materials make up 90% of the total MEA cost.

	MEA ¹ (\$/m ²)
Material	135.48
- Membrane	- 13.89
- Electrode	- 109.61
- GDL	- 11.98
Capital Recovery	7.08
Labor	0.99
Tooling & Equipment	3.80
Other²	1.73
Sub-Total	149.08
Total	158.03

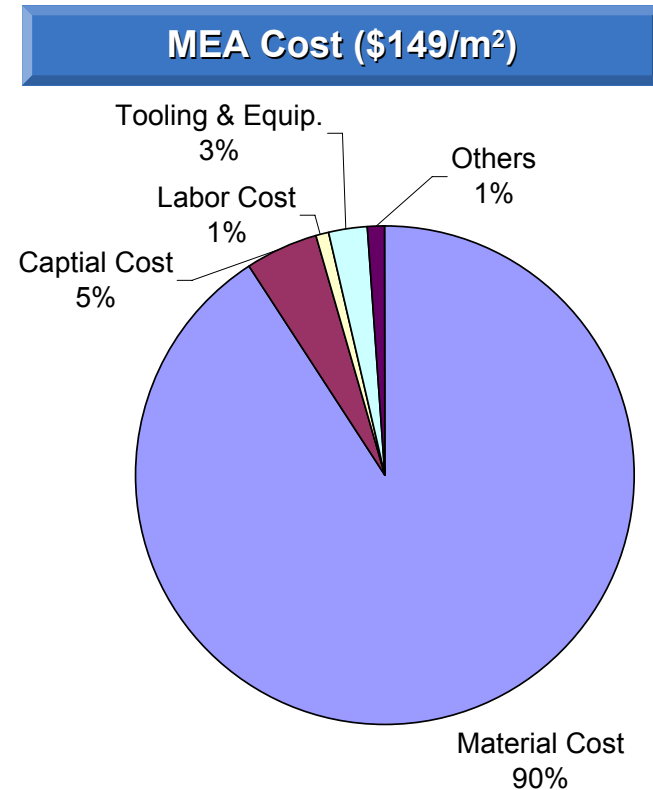

In 2005, the MEA cost was higher due to higher material costs for the membrane (2 mil), electrodes (Pt loading = 0.75 mg/cm²) and GDL (woven carbon fiber = \$30/kg).



¹ m² of active area and kW of net power

² Other costs include utilities, maintenance, and building

Processing costs can be significant for BOP components. For example, material costs represent just half the membrane humidifier cost.

Membrane Humidifier Cost (\$107)

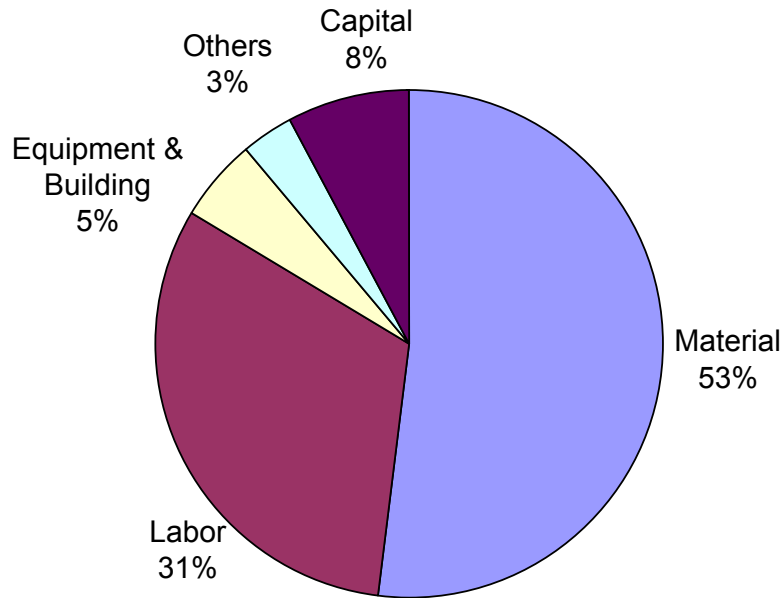

Membrane Humidifier Cost (\$)

Component	#	Material (\$)	Process (\$)
Right side housing	1	2.62	0.84
Small O-ring	2	1.00	0.00
Big O-ring	2	1.00	0.00
C-clip	2	0.20	0.00
Nafion tubes	2500	44.33	41.41
Nafion tube housing	1	1.51	0.89
Nafion tube header	2	0.20	0.00
Mesh filter	2	0.20	0.00
Left side housing	1	2.62	0.84
Assembly & packaging	-	2.05	6.93
Sub Total	-	55.73	50.91
Total	-	106.64	

The 2006 annual cost update revised key cost drivers in the 2005 projection.

- In 2005, the cost projection went through a significant review
 - Assessment of membrane and other MEA component costs
 - Used ANL updated system configuration
 - Discussion BOP component specifications and costs with developers
 - Revised power density and platinum loading assumptions based on Tech Team and industry inputs
 - Increased platinum cost to reflect market conditions
- In 2006, the performance assumptions and platinum price were updated
 - Power density
 - Platinum loading
 - Platinum price

We did not change the system configuration or BOP cost projection in 2006.



We updated the stack cost in 2006 based on industry input on power density, platinum price, and platinum loading.

Scenarios	Power Density (mw/cm ²)	Pt loading (mg/cm ²)	Pt Cost (\$/troz)	Pt Conver. Cost (\$/troz / % of Pt Cost)	Total Catalyst Cost (\$/troz / \$/g)	BOP (\$/kW)	Stack (\$/kW)	Total (\$/kW)
2005 Baseline	600	0.75	900	180 / 20%	1,080 / 34	41	67	108
2006 with \$900/troz Pt	700	0.65					52	93
2006 with \$1,100/troz Pt (baseline)			1,100	110 / 10%	1,210 / 38		56	97

- The increase in power density drives the reduction in the stack cost by approximately 20%
- The increased Pt cost (LME + Conversion) is mostly offset by the decreased Pt loading
- Overall, the new performance parameters and platinum price lowered the stack cost by 16% and the overall system cost by 10%.



In 2006, we used a bottom-up approach to determine the impact of production volume on stack manufacturing cost.

Preliminary Results – Stack Cost (\$/m²)

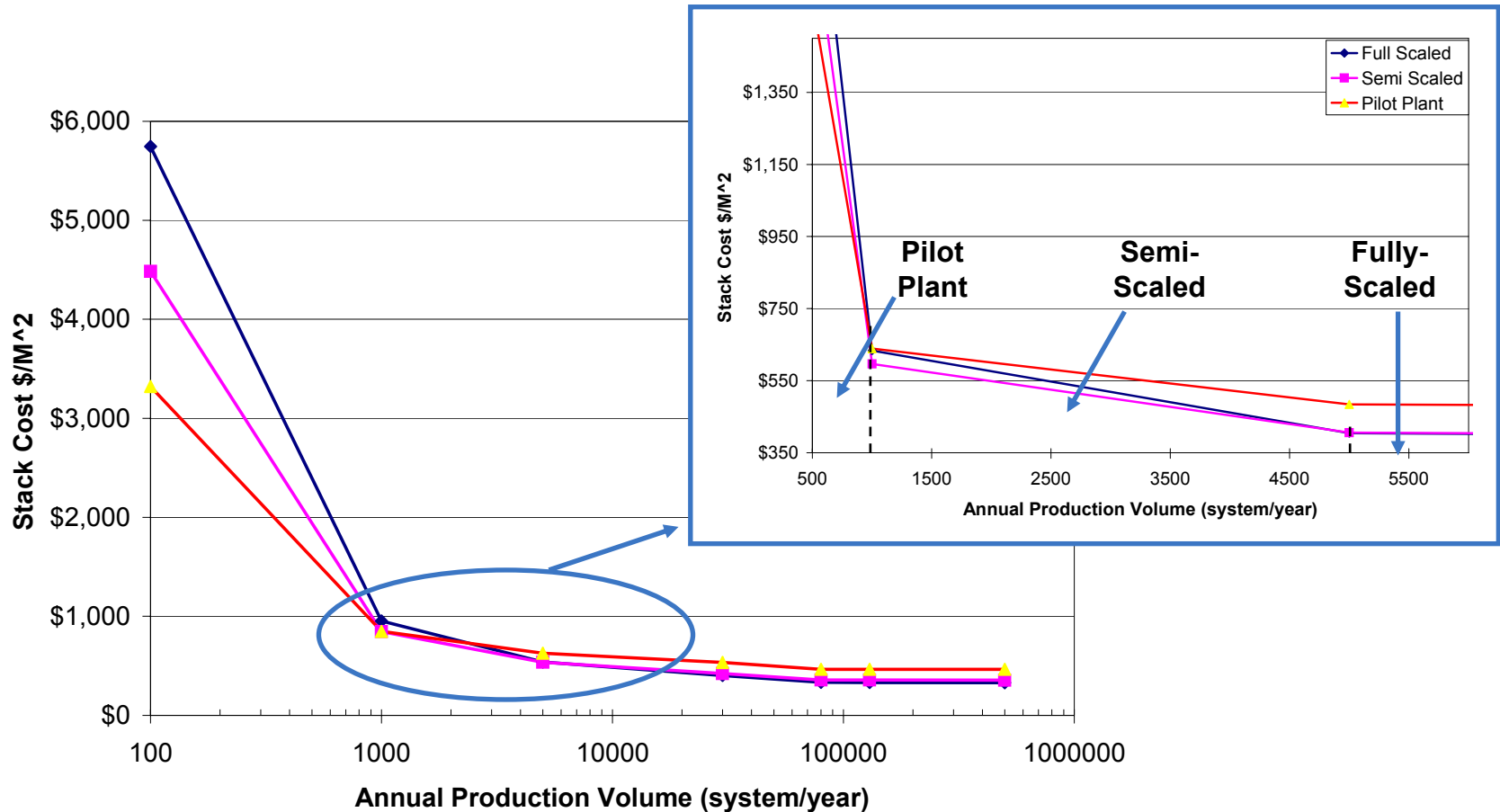

CAPEX controls the stack cost at low volume, while material cost dominates as the production volume increases.

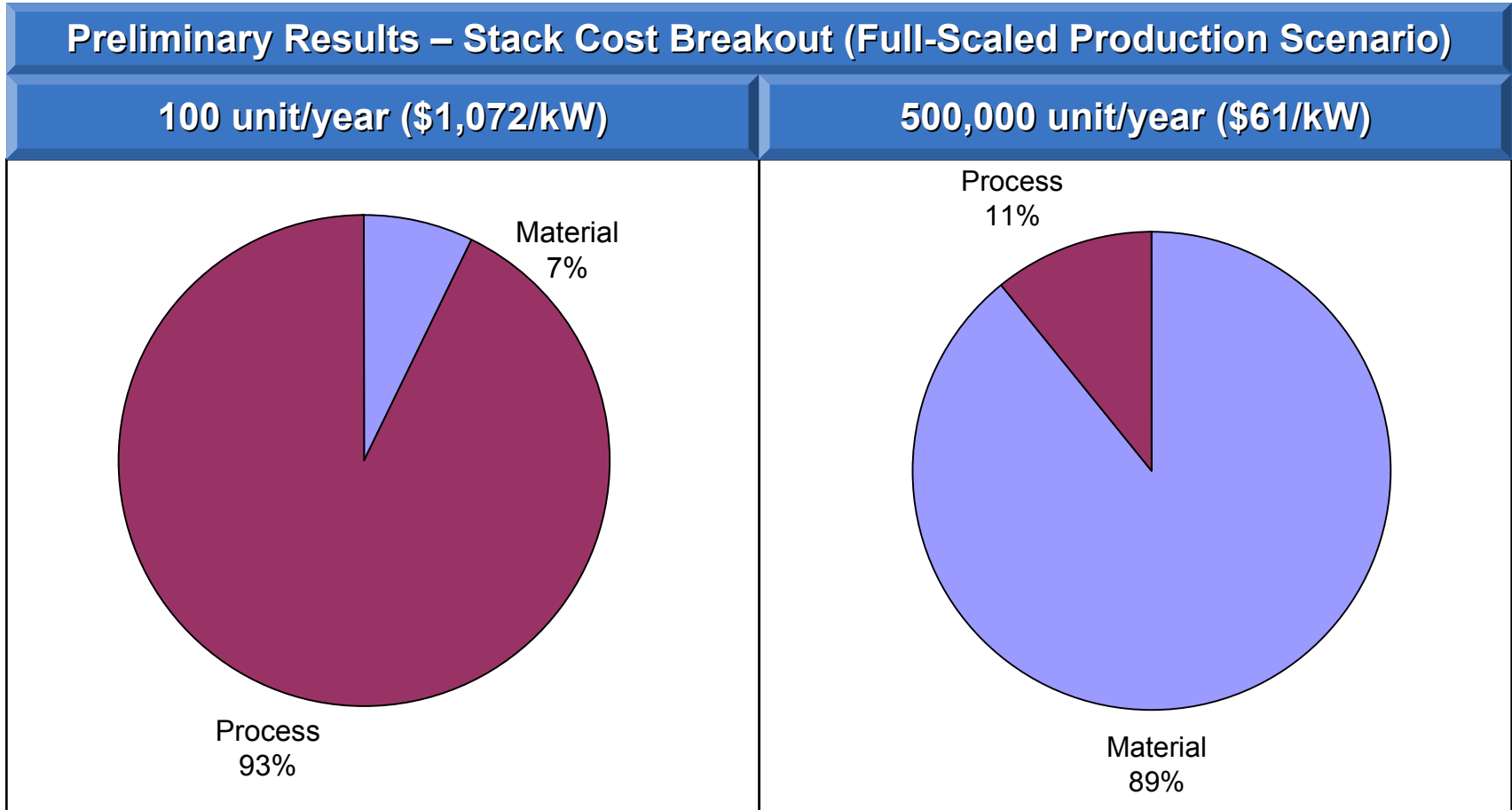

This year's tasks commenced in February and will be concluded by the end of September.

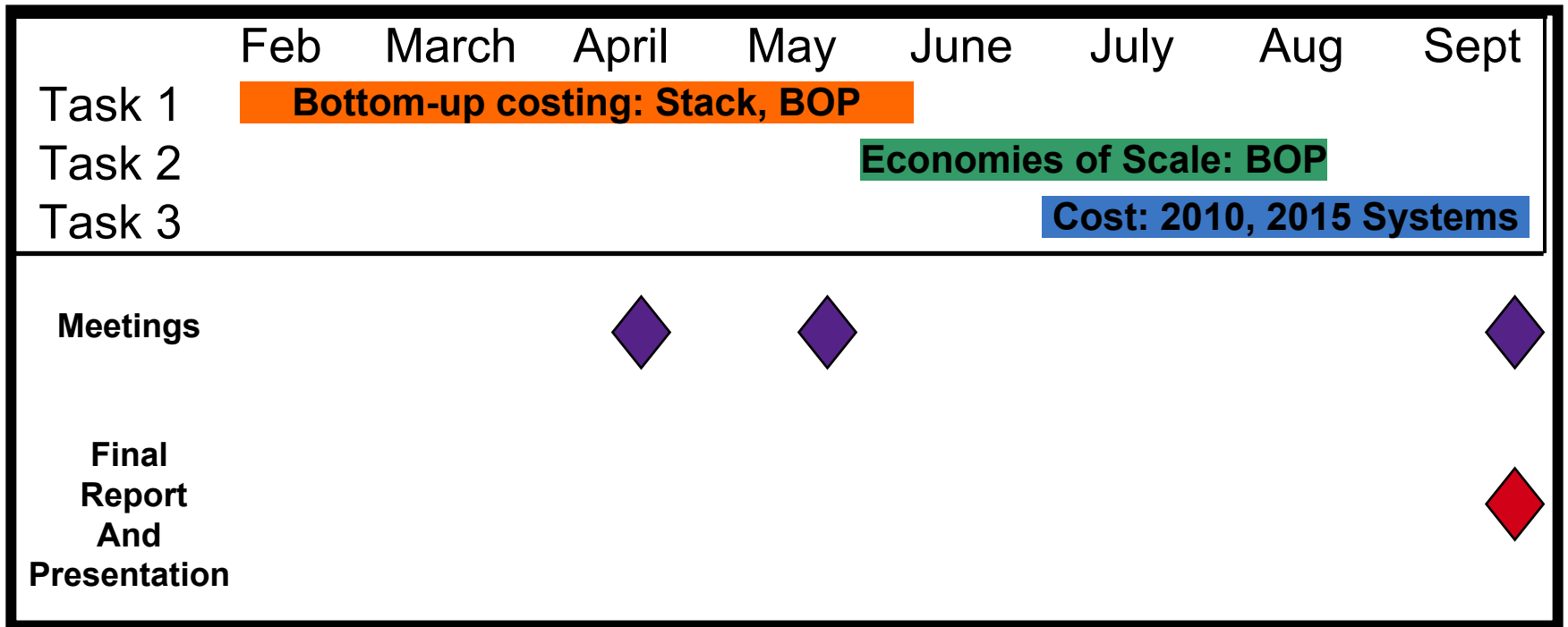

Task 1 includes the development of a manufacturing cost model of BOP components and modifications to our stack cost analysis to reflect the changes in the 2007 stack configuration.



We are following a three-step process to develop the overall system cost projection.

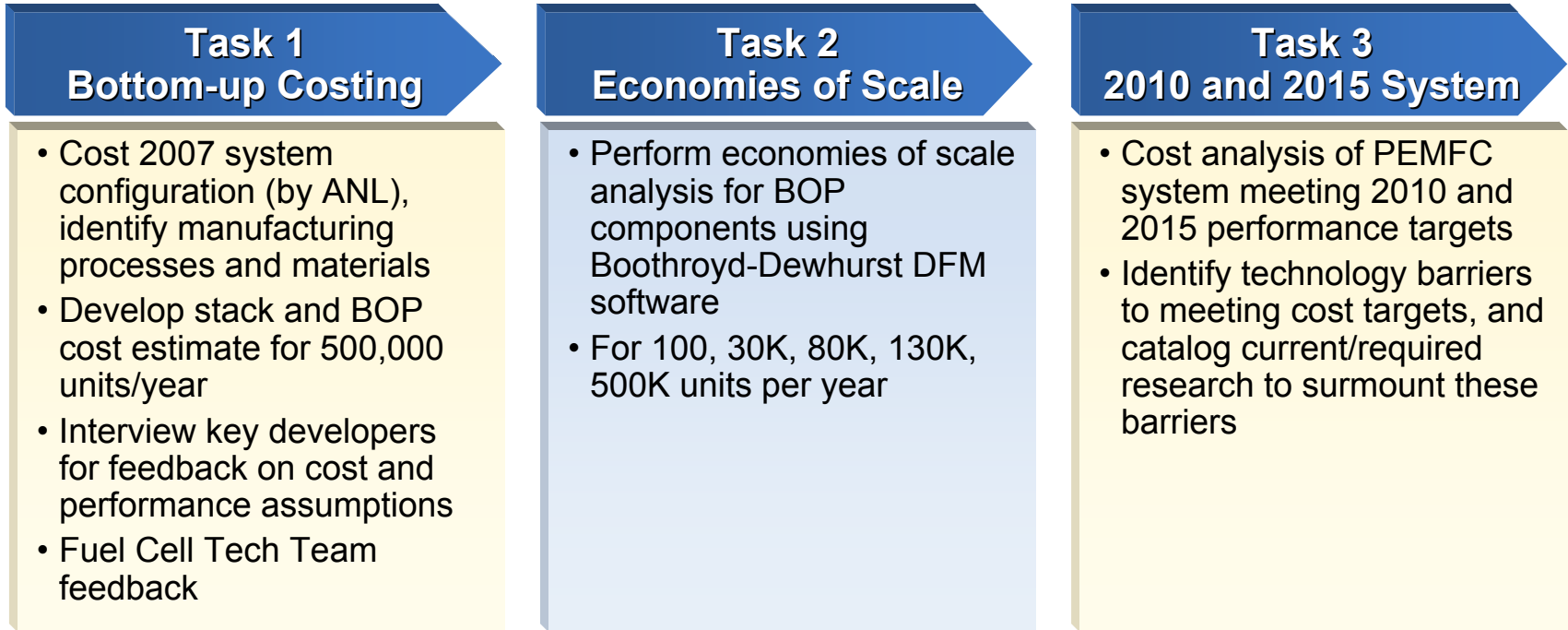

Deliverables

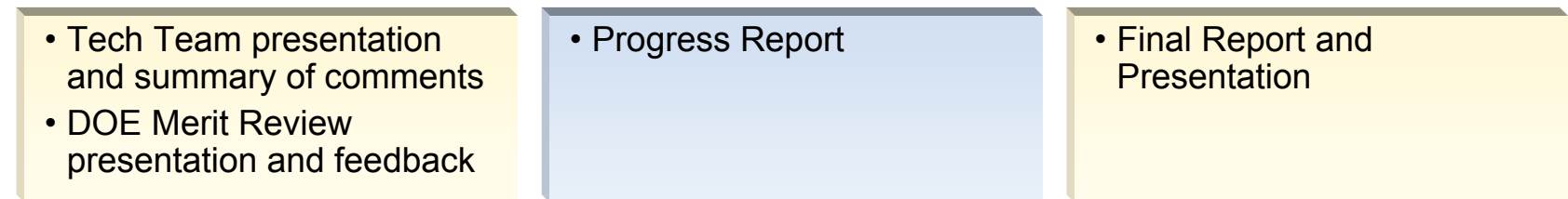

We will contact developers of key stack components for their feedback on performance and cost assumptions.

- MEA
 - 3M, DuPont, Gore
- GDL
 - E-Tek
 - SpectraCorp, Toray, SGL Carbon
- Bipolar Plates
 - Porvair, GrafTech, DuPont, SGL Carbon, Schunk
 - Raw Materials - Superior Graphite, Asbury Carbons
- Seals
 - Freudenberg, SGL Carbon
- Stack and System Integrators
 - Ballard
 - Tech Team (GM, Ford, Chrysler)

We will also contact vendors to obtain feedback on estimated high-volume factory costs for the BOP components.

- Air Management
 - Honeywell (compressor-expander)
 - Vairex (blower)
- Thermal Management
 - Modine
- Water Management
 - PermaPure (Nafion membrane-based)
 - Emprise (enthalpy wheel)
- Fuel management
 - H₂ Systems
 - Barber-Nichols, Rietschle-Thomas, Kolbenschmidt-Pierburg