

Development of Solar-powered Thermochemical Production of Hydrogen from Water

Chris Perkins for the Solar Thermochemical
Hydrogen (STCH) Team

16 May 2007

This presentation does not contain any proprietary or confidential information

Overview

Timeline

- **Start: 6-25-2003**
- **End: 12-31-2007**
- **Percent complete: 65%**

Budget

•Total Project Funding

\$11,118,362 DOE

\$1,886,852 Cost share

•Funds received in FY06

\$3,366,000

Barriers

AU. High-Temperature Thermochemical Technology

AV. High-Temperature Robust Materials

AW. Concentrated Solar Energy Capital Cost

AX. Coupling Concentrated Solar Energy and Thermochemical cycles

Partners

**The University of Nevada, Las Vegas The University of Colorado Sandia National Laboratories
The National Renewable Energy Laboratory Argonne National Laboratory General Atomics
ETH-Zurich TIAX, LLC**

Objectives

- Identify a cost competitive solar-powered water splitting process for hydrogen production
- Conduct experimental studies to complete quantitative selection
- Numerical and experimental evaluation of solar receiver concepts for integration with thermochemical processes
- Implement consistent methodology for comparing economic viability of cycles

Approach

- Design and implement a thermodynamic and experimental comparative assessment methodology to screen all known thermochemical cycles and select the top several performers
- Carry out critical experimentation to determine the real viability of down-selected cycles
- Develop validated designs for solar collector system components for integrated system analysis
- Analyze cost and efficiency metrics for integrated cycle performance
- Develop demonstration plant concept design(s) for surviving 1 to 3 competitive cycle(s) and demonstrate them at a semi-integrated bench scale, including on-sun testing

Technical accomplishments/ progress/results

- Cycle database, scoring, and initial down-select completed
- Experimental work on 5 cycles targeting cycle closure/viability studies
- CFD modeling for developing understanding of thermal transport in two solar receiver concepts
- Experimental prototypes designed and under construction for aerosol reactor, solid particle receiver, and CR5 ferrite reactor
- Initial cost analysis performed for two leading cycles

Cycle selection and investigation

- 351 unique cycles have been discovered and scored
- 12 cycles found to be worthy of further experimental study
- 5 of those 12 are currently under active study by SHGR

Volatile Metal Oxides

•Zinc oxide

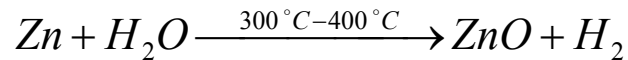
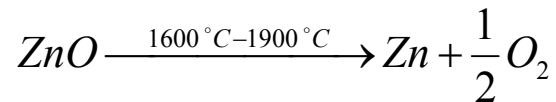

•Cadmium Carbonate

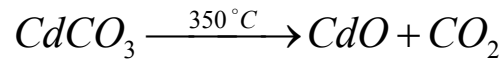
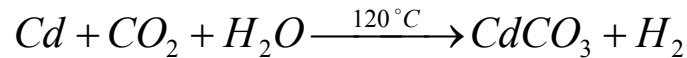
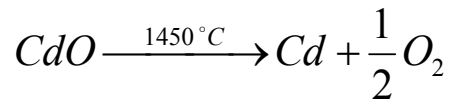

Non-volatile Metal Oxides

•Sodium manganese

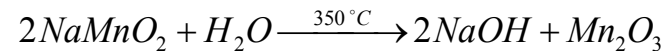
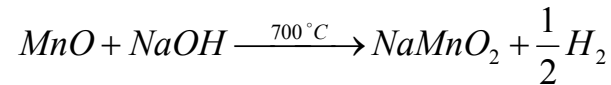
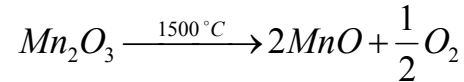

•Cobalt ferrite

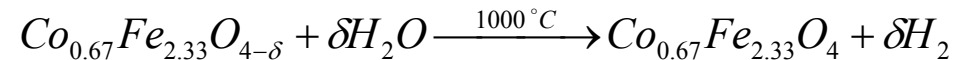
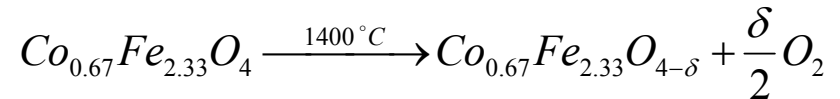

Other

•Hybrid copper chloride

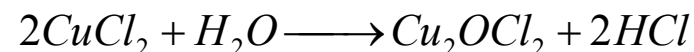
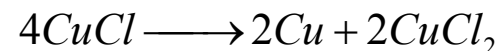
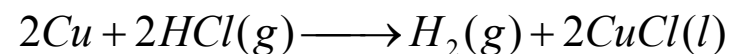
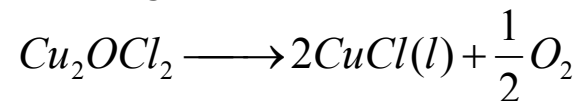

Aerosol Dissociation of ZnO

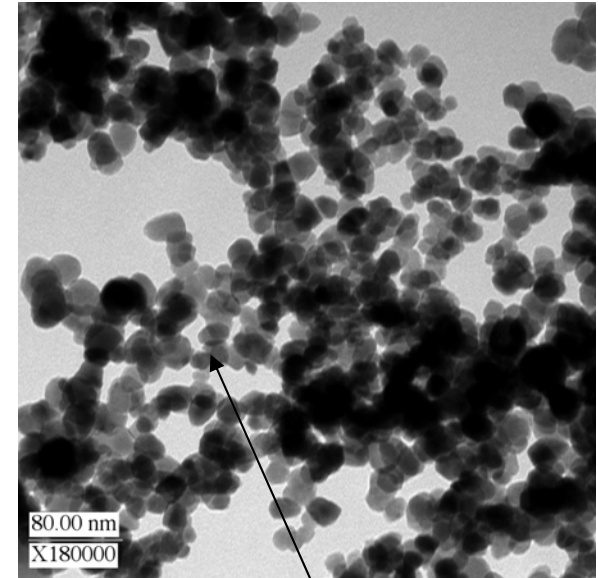
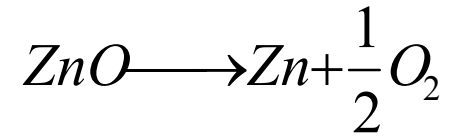
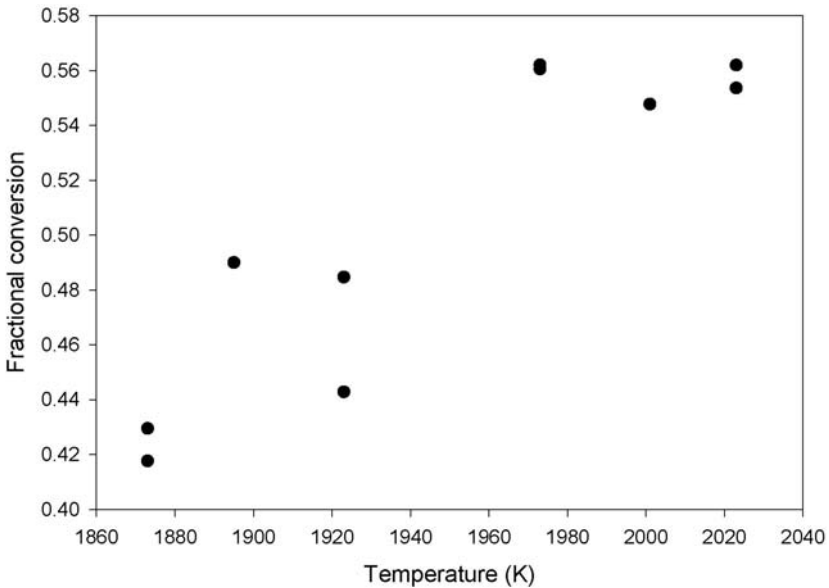

- Forward conversions > 55% in less than 1s residence time
- Net conversions ~40% - highest ever achieved
- Aerosol rates 3-4 orders of magnitude greater than stationary configurations
- Rapid quench mitigates recombination

- Extremely small product particles (>50 nm) give fast rates in H₂ generation step

Aerosol processing can give fast rates for many high temperature cycles

- 9 cm ID x 117 cm Al₂O₃ tube

Production of hydrogen from Zn/H₂O

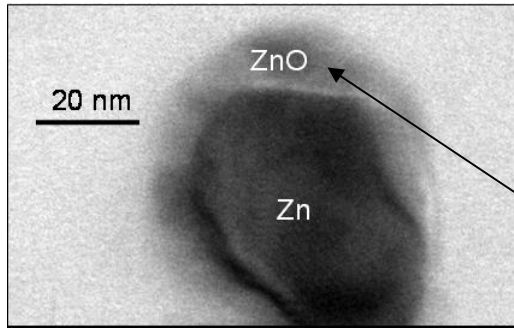

Passivating ZnO film

Reacted particle

- Successful generation of hydrogen
- Reaction is mass transfer limited – small particles are better
- Aerosol rates much faster than stationary configurations

Nano-size Zinc Conversion (<1 sec)

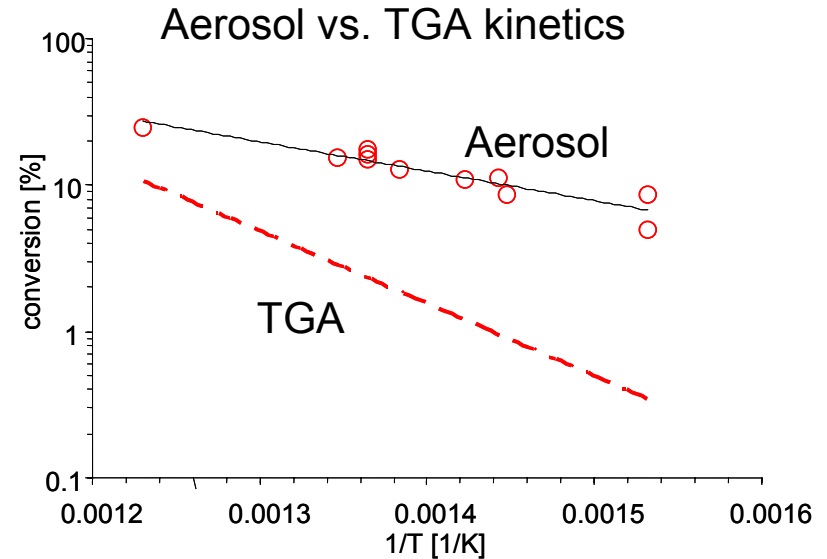

Aerosol Kinetics >> TGA Kinetics



On-sun cycle testing in progress at High Flux Solar Furnace (NREL)

Hydrogen production from Cd/H₂O

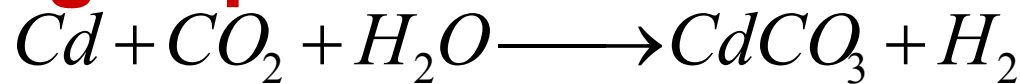

- H₂ production a strong function of available Cd surface

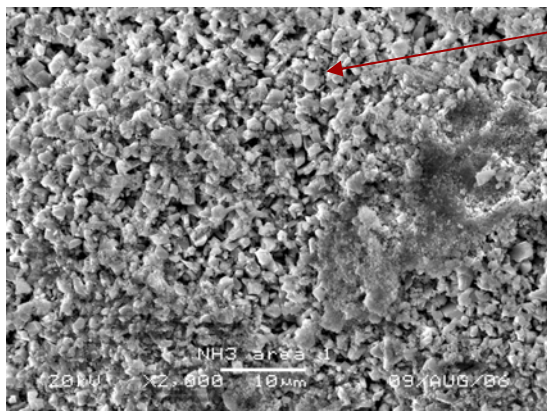

CdCO₃ crystals

- Cd(OH)₂ forms passivating layer on Cd
- CdCO₃ present as porous crystals
- Attrition can open more Cd surface to reaction, speed H₂ generation rates
- Rates have been increased to 5% total conversion/hr

Cd + H₂O + NH₄HCO₃

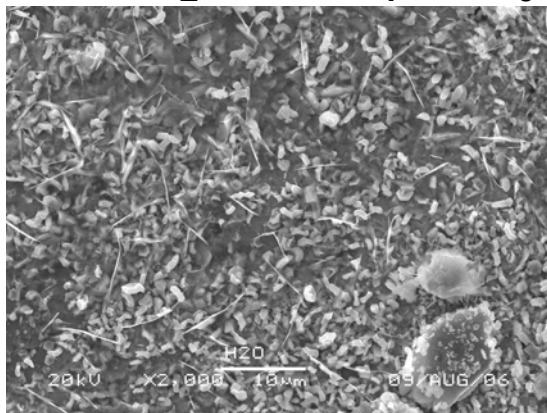

Cd + H₂O

Ball milling

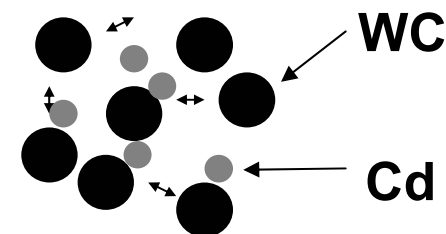

Conversion:

4%/hr

Grinding

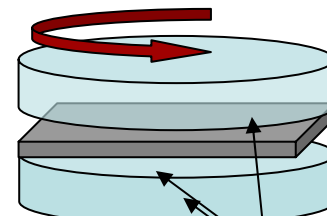

TiC coated

5%/hr

Kinetic model for CdO decomposition

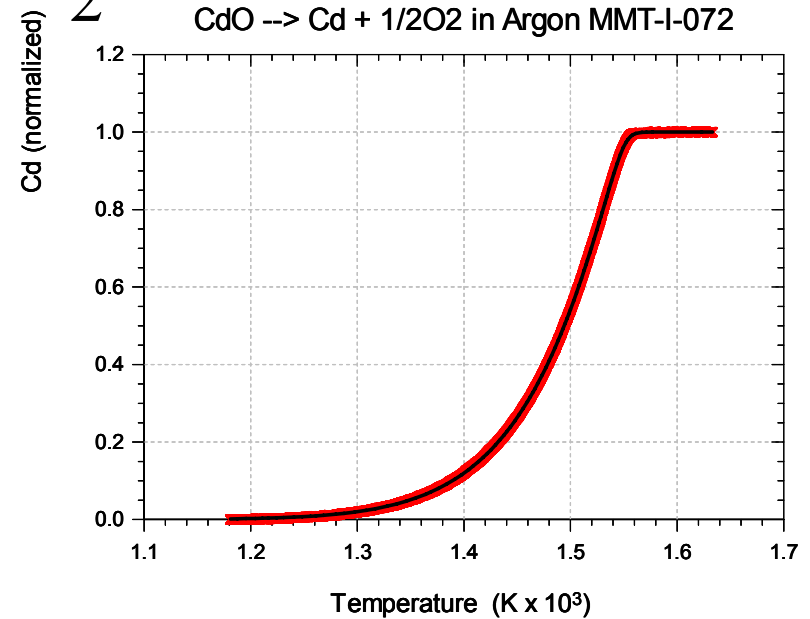
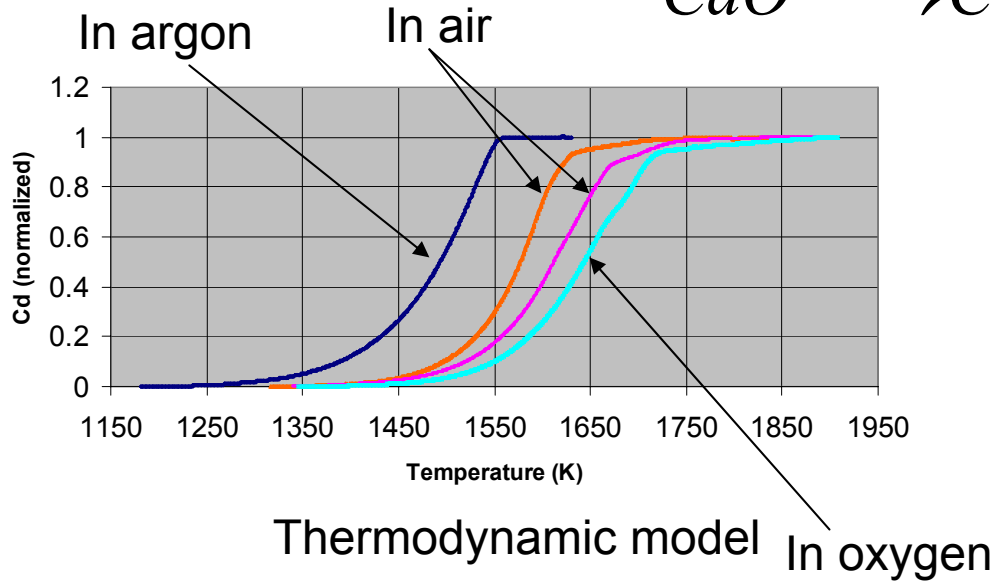
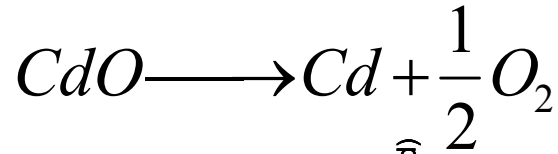

Kinetic analysis in TGA

$$\frac{dX}{dt} = k_0 e^{\frac{-E_a}{RT}} (1-X)^n$$

In argon: $E_a = 269.4 \text{ kJ/mol}$, $k_0 = 1.36 \times 10^9 \text{ s}^{-1}$

In air: $E_a = 470.9 \text{ kJ/mol}$, $k_0 = 2.57 \times 10^{15} \text{ s}^{-1}$

In oxygen: $E_a = 438.9 \text{ kJ/mol}$, $k_0 = 6.39 \times 10^{13} \text{ s}^{-1}$

- Presence of oxygen strongly affects CdO decomposition temperature
- Kinetics confirm thermodynamic predictions
- Reaction should be operated in inert to mitigate recombination, speed rates
- Work continues on investigation of recombination reaction

Solar Ferrite Cycle Closure Demonstrated

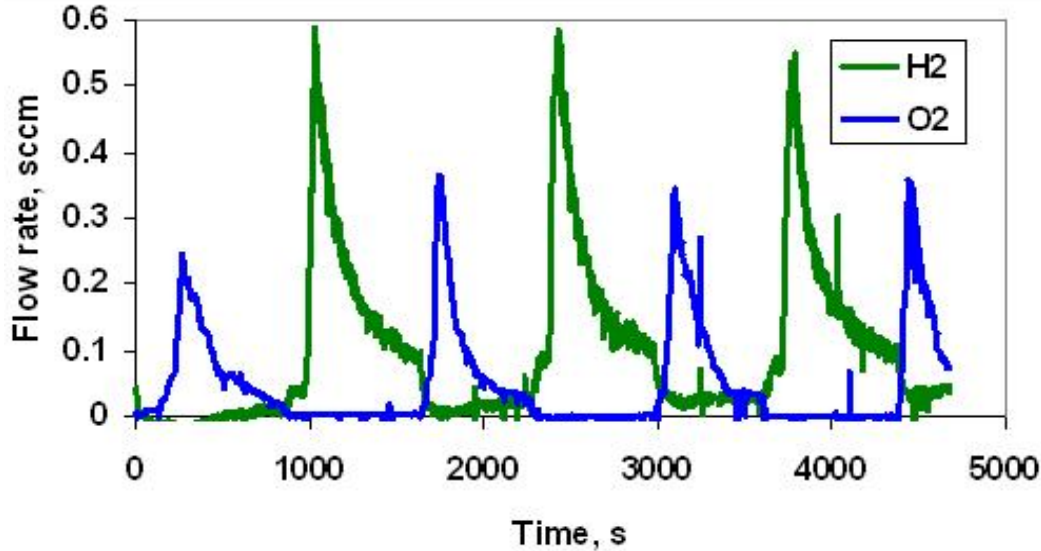
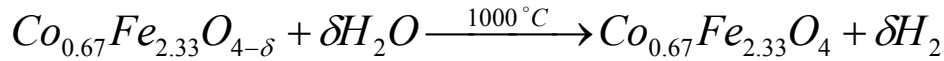
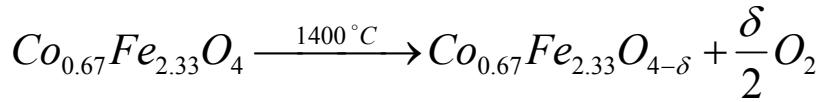

- On-sun reduction at 1550 °C, H₂ production at 1100 °C
- YSZ-stabilized ferrite shows stability, repeatability
- First cycle closed “on-sun”

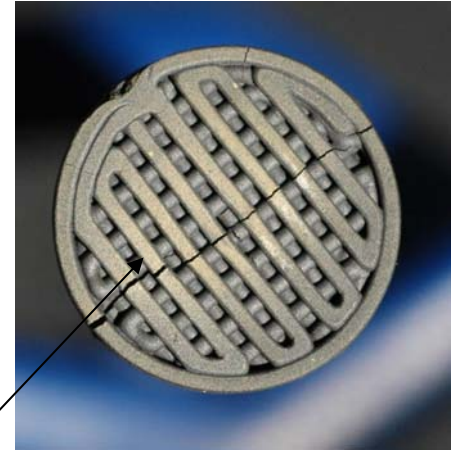

Before reaction

Ferrite monoliths

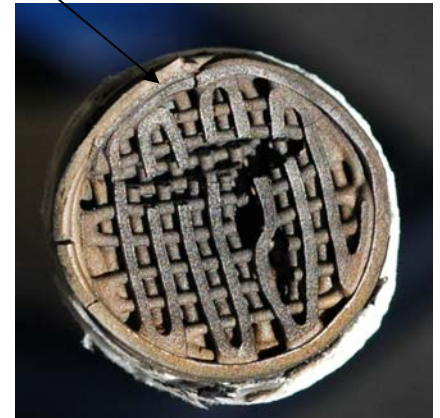

After 30 cycles

CR5 ferrite reactor constructed and ready for on-sun testing

- The prototype CR5 device will operate at a solar input of 9kW
- A set of 14 counter-rotating disks contain about 1.5 kg of ferrite material
- Hydrogen production goal of > 100 slph H₂ in August of 2007

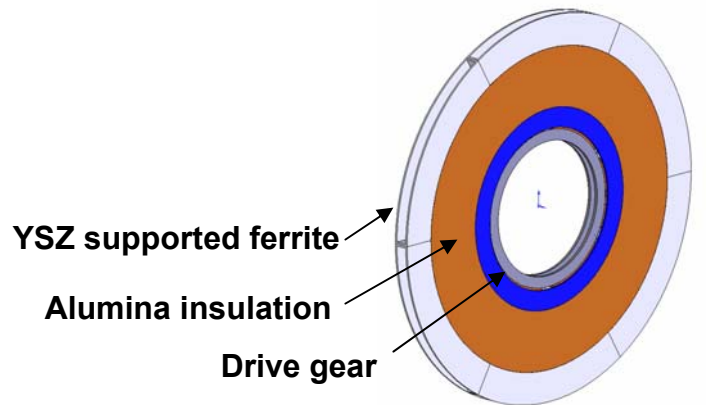

CR5 Rotating Ring

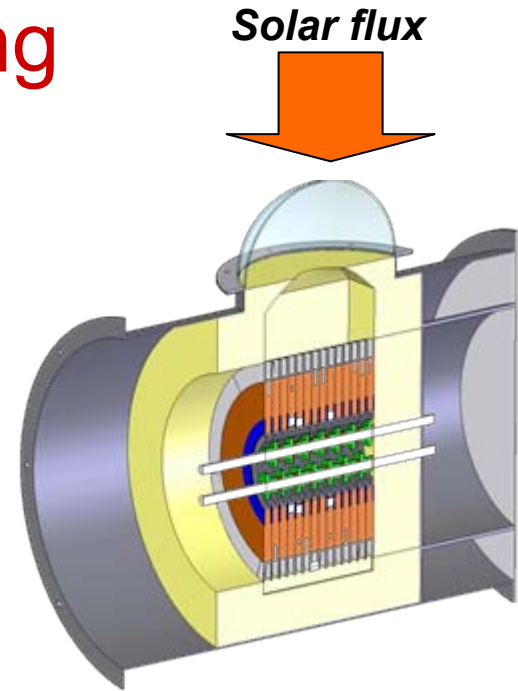

CR5 Cross Section

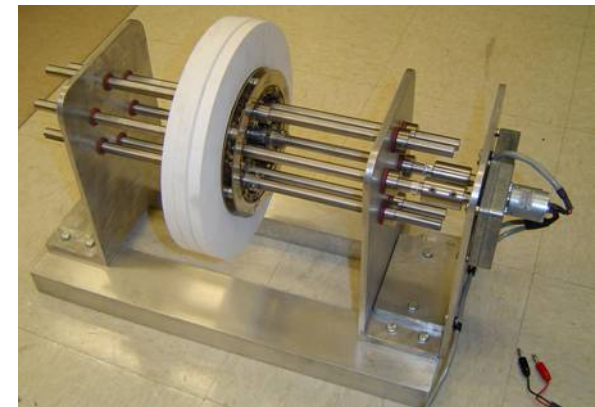

CR5 Drivetrain with Three Rings

Successful reaction of CuCl_2

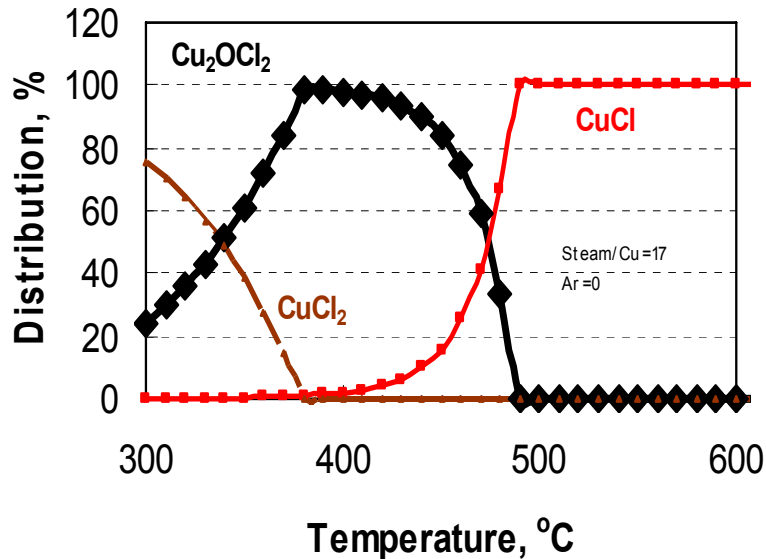
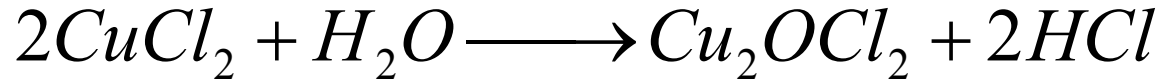

Thermodynamic prediction

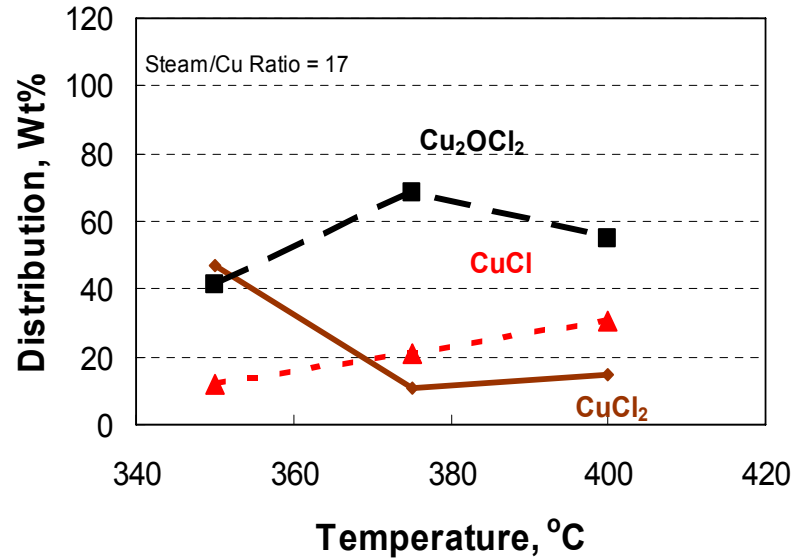

Experimental results

- Thermodynamics predict 98% yield of desired Cu_2OCl_2 at 375°C and no significant CuCl formation with steam to copper molar ratio of 17

- Experiments show up to 85% Cu_2OCl_2 production
- Significant amounts of CuCl produced – needs to be mitigated

New design for electrochemical cell

- Electrochemical reaction:

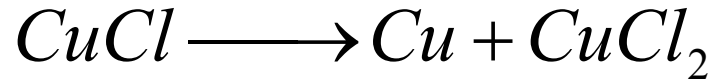

- Original design:
 - Electrochemical flow cell using graphite resistant graphite plates
 - Corrosive CuCl_2 caused Cu deposition and membrane destruction

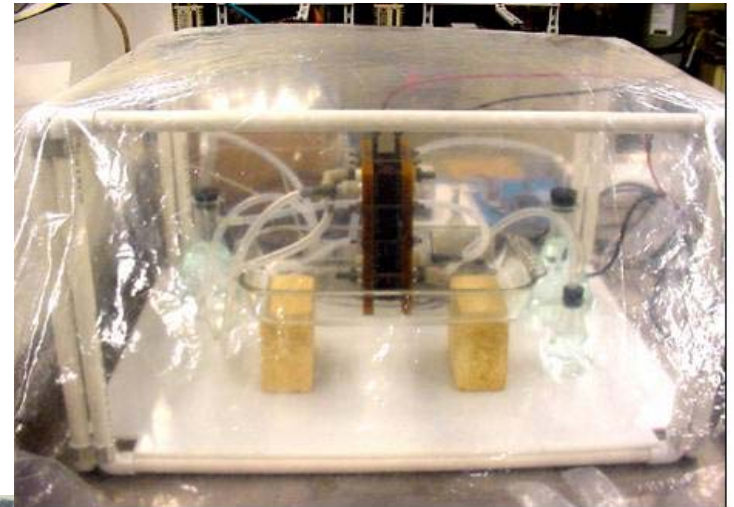

- New design:
 - Plastic frame with graphite channels
 - Work focused on improving cation exchange, reducing shunt current



6 months ago

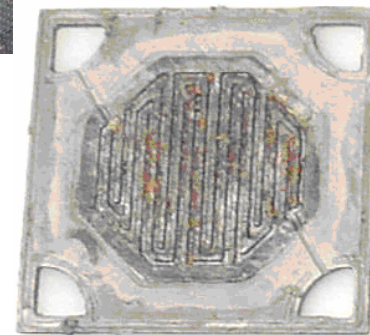

Today

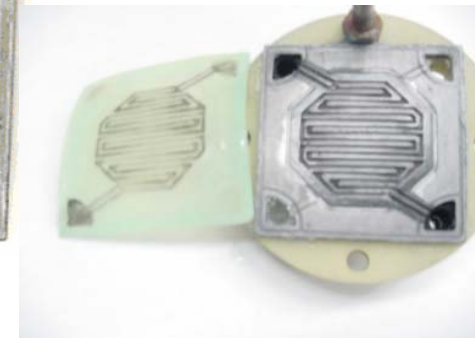

Solid particle advanced solar receiver for thermochemical processes

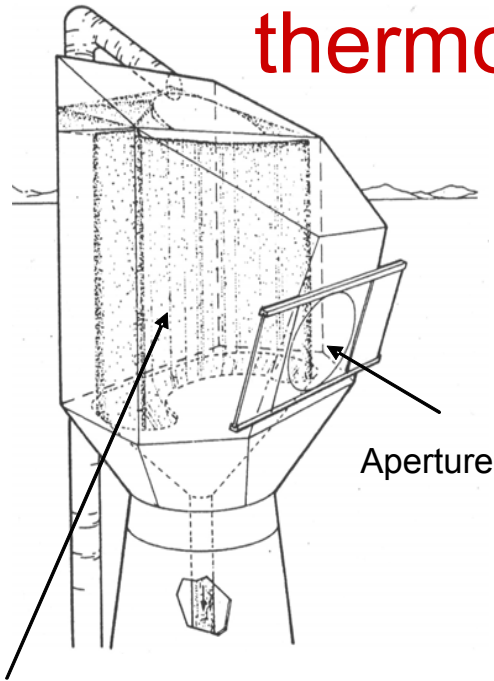

Particle curtain

- Can achieve temperatures in excess of 950 °C
- Falling particles directly heated by solar radiation
- Two-storage tanks and heat exchanger couple to thermochemical process

Cold flow testing completed

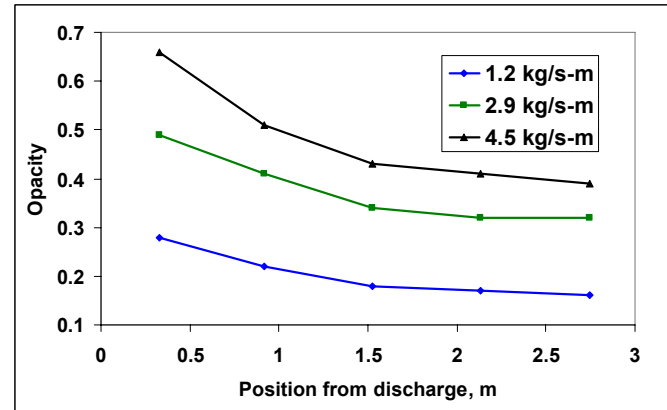

Increasing the mass flow rate increases the overall curtain opacity and receiver efficiency

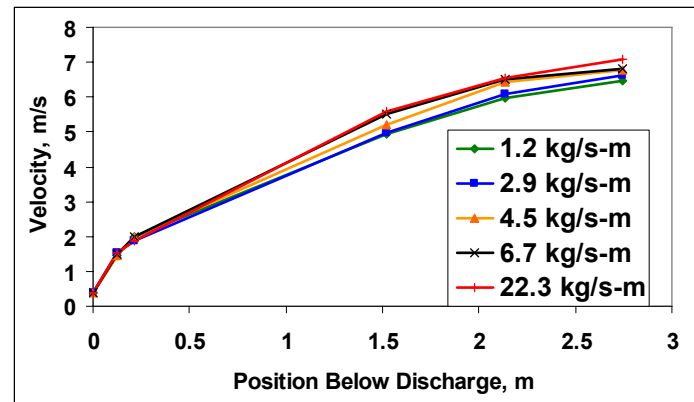

Particle velocity affects receiver residence time and particle temperature

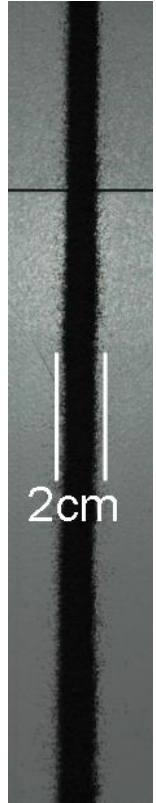
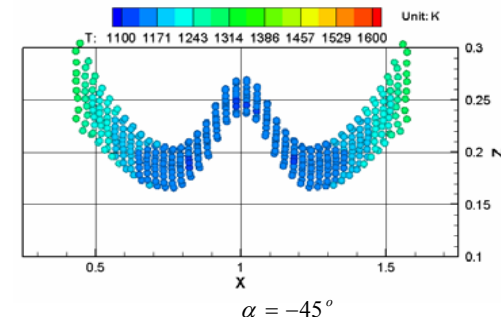
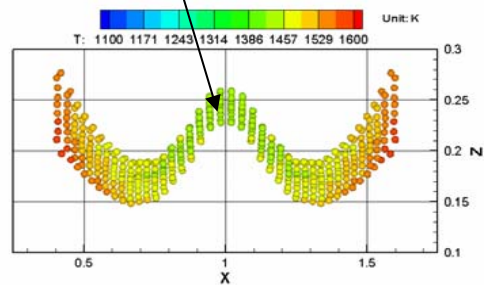
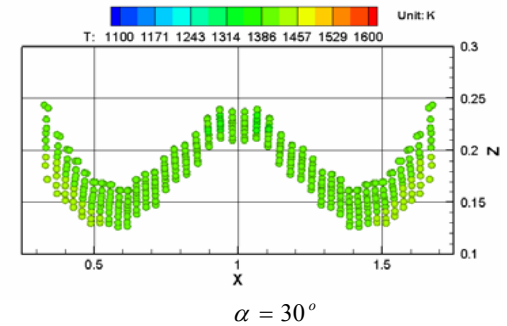
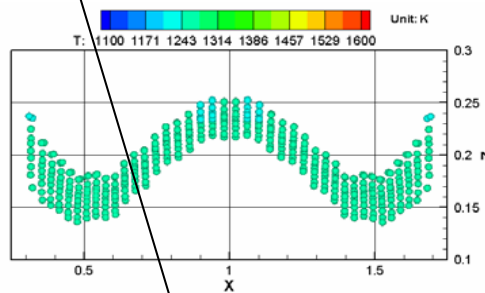
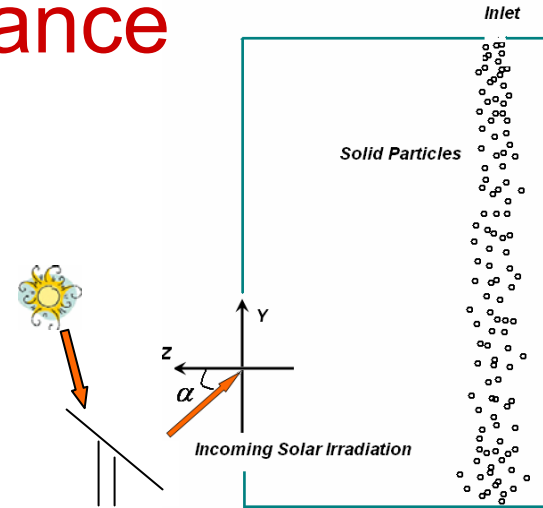
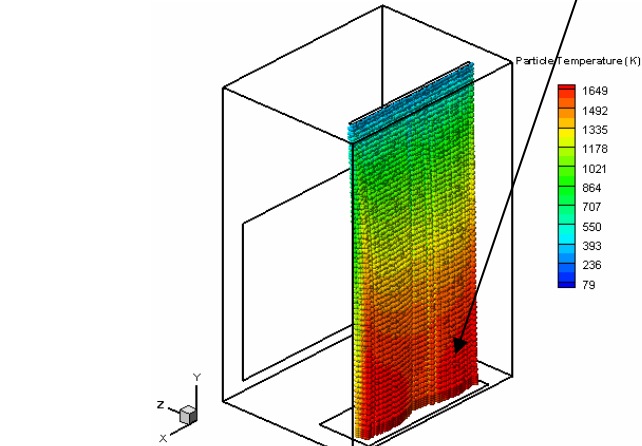
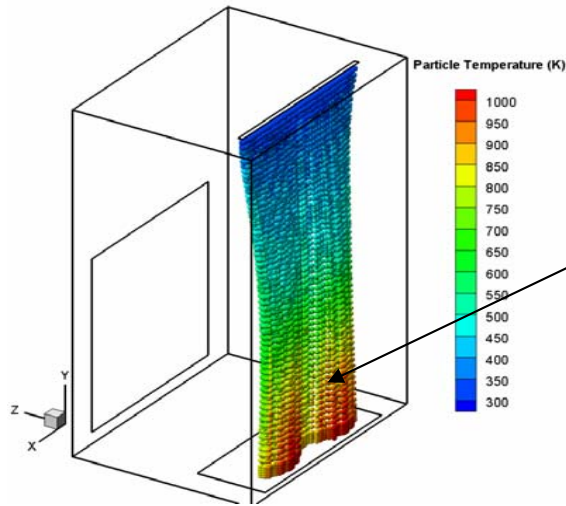

Image taken on side showing curtain thickness

Numerical modeling performed to optimize particle receiver performance

- Small particles give high temperatures, but unstable curtain
- Polydisperse particles give stable, high temperature curtain
- Highest temperatures for incidence angle of 30°



Solid Particle Receiver Design and Construction

- The design and load analysis for the 1MWth Solid Particle Receiver (SPR) has been completed.
- Construction activities have begun
- Testing on-sun at the National Solar Thermal Test Facility (NSTTF) is set for Oct. 2007.

SPR will be tested on top of the power tower



National Solar Thermal Test Facility (NSTTF) at Sandia National Labs

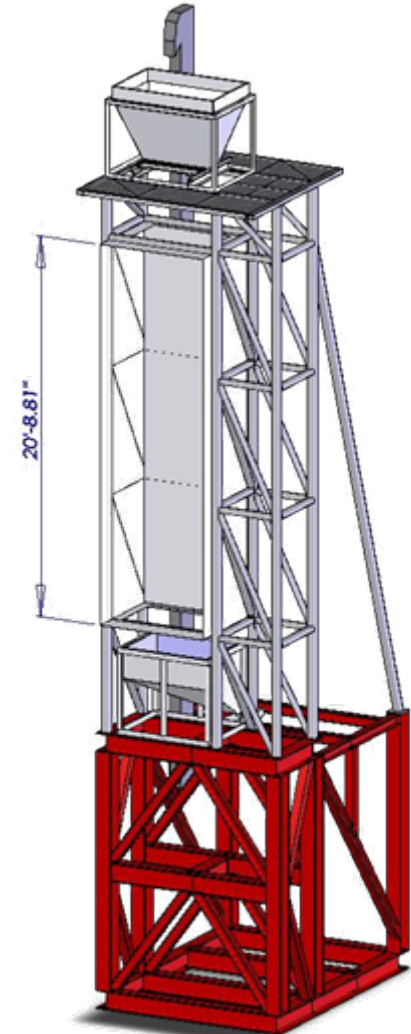

Solid particle receiver prototype test platform

Advanced solar chemical receiver/reactor design

- Design for operation of volatile and non-volatile metal oxide cycles
- Can efficiently transfer solar energy to thermochemical process

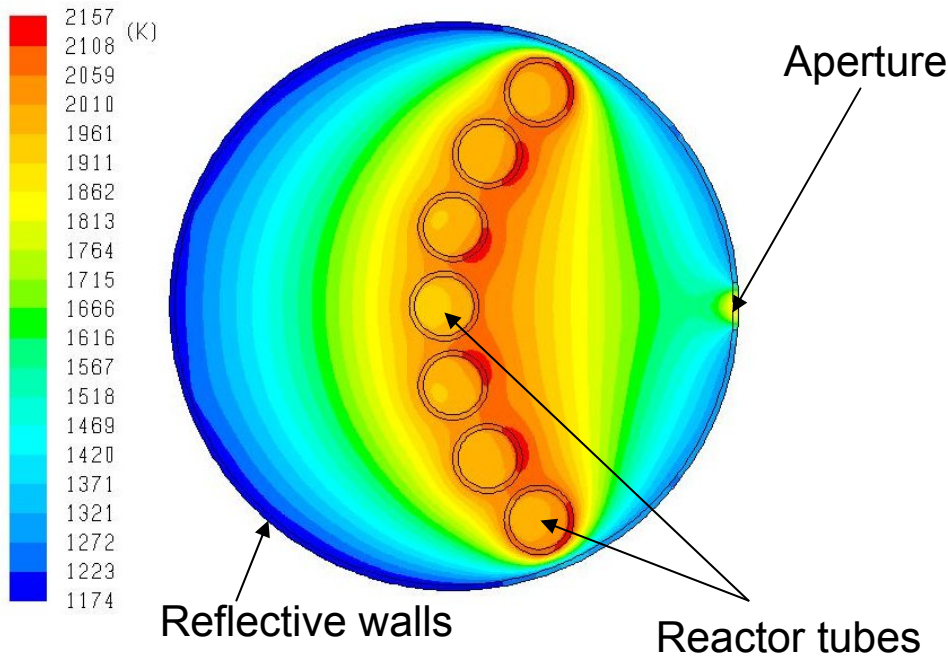

Multi-tube design gives high (>36%) receiver efficiency

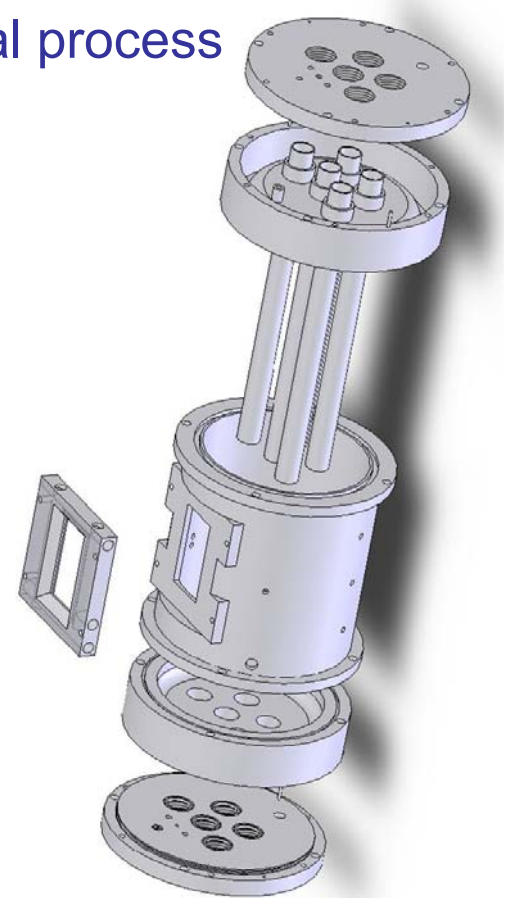

- 5-tube reactor under construction
- Testing at NREL August 2007

Economic evaluation of thermochemical processes

- Use H2A framework to develop consistent evaluation technique
- 2 processes examined: Zn/ZnO and Hybrid Sulfur
- Central production, 100,000 kg H₂ /day

ZnO/Zn - 2025

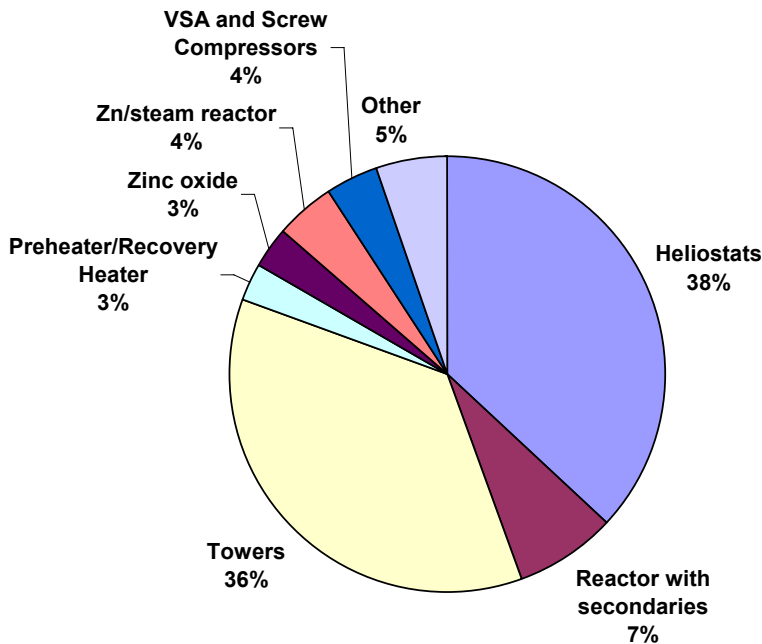

Zn/ZnO: H₂ costs between \$3.10 and \$4.85/kg

HyS - 2025

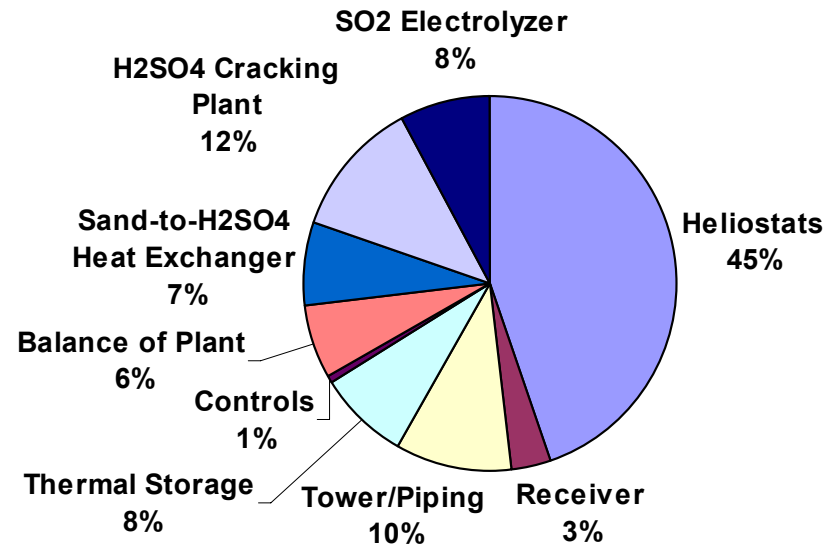

HyS: H₂ costs between \$2.50 and \$3.15/kg

Heliostat Cost Reduction Study

- Heliostats contribute ~50% to the cost of solar H₂ plant
- Two workshops were held to brainstorm ideas for heliostat cost reduction
 - 30 international experts in heliostats and manufacturing
 - ~40% cost reduction possible through significant R&D
- Advanced heliostat design and manufacturing development can enable <\$3/kg solar H₂ production
- SAND report will soon be published

TODAY



**FUTURE
POSSIBILITIES**

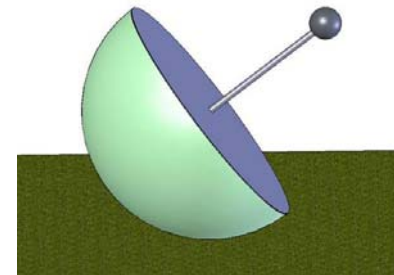
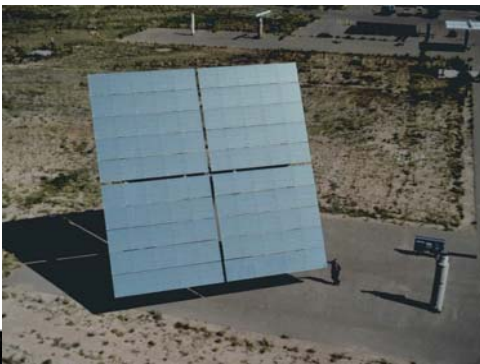

Future Work

- Complete closure of 5 experimental cycles to determine technical feasibility and down-select
- Demonstrate “on-sun” CR5 ferrite reactor, solid particle receiver, and cavity aerosol receiver
- Demonstrate integrated cycle operations “on-sun”
- Continue materials research for implementation in solar receiver and other system components
- Down-select cycles through H2A evaluation of economic performance

Summary

- **Objective:** Evaluate solar thermochemical water-splitting routes to hydrogen production
- **Approach:** Screen cycles based on technical criteria, experimentally investigate most promising cycles, develop schemes for solar integration, evaluate economic viability of cycles
- **Technical accomplishments/progress:** Completed scoring process, demonstration of all reactions in 5 selected cycles, determination of kinetic/limiting factors in each cycle, design and modeling of three advanced reactor concepts, development of economic methodology for evaluating cycles
- **Future work:** Integrated closure of down-selected cycles, “on-sun” operation of advanced reactor concepts, exploration of materials challenges for solar implementation