

# A Novel Slurry Based Biomass Reforming Process (DE-FG36-05GO15042)

---

T. H. Vanderspurt, S. C. Emerson, Y. She,  
S. Arsenault, R. Hebert, J. MacLeod,  
G. Marigliani, & R. Willigan

15 May 2007

United Technologies Research Center, East Hartford, CT

This presentation does not contain any proprietary, confidential, or otherwise restricted information

Project ID: PDP 1

# Overview

---

## Timeline

- Start – May 2005
- End – Oct 2008
- ≈10% Complete

## Budget

- Total Project Funding
  - DOE share - \$2.9M
  - Contractor share - \$737k
- Funding Received in FY06
  - \$0k
- Funding for FY07
  - \$700k (projected)

## Barriers

- Hydrogen, Fuel Cells and Infrastructure Technologies Program Multi-Year Research, Development and Demonstration Plan
  - V. Feedstock Cost and Availability
  - W. Capital costs and efficiency of technology

## Partners

- University of North Dakota Environment Energy Research Center

# Approach: Biomass Slurry to Hydrogen Concept

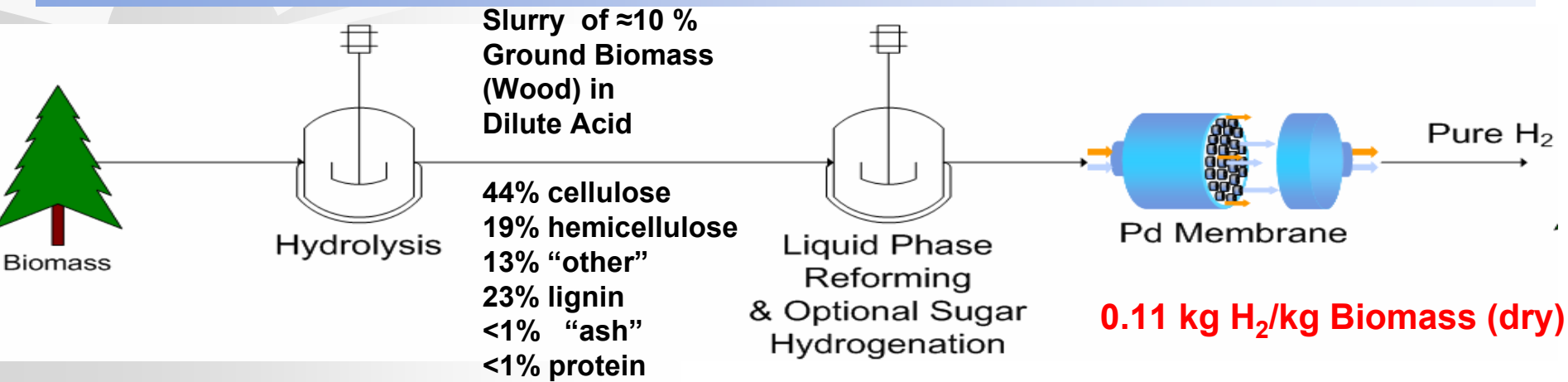

- Fuel flexible, using raw, ground biomass such as wood or switch grass
- Carbon neutral means to produce Hydrogen
- H<sub>2</sub> separation: Leverage experience with Advanced Pd membranes

# Biomass Gasification to Hydrogen Concept

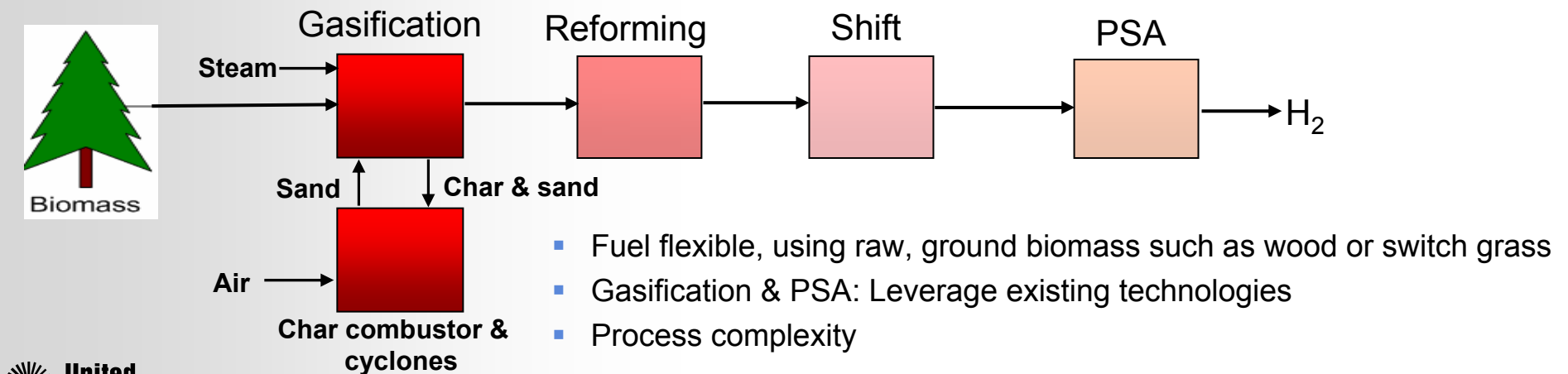

# Objectives

---

- (2Q2007) Illustrate, through an initial feasibility analysis on a **2000 ton/day** (dry) biomass plant design, that there is a viable technico-economical path towards the DOE's 2012 efficiency target (**43% LHV**) and assess the requirements for meeting the DOE's cost target (**\$1.60/kg H<sub>2</sub>**).
- (3Q2007) Demonstrate, through preliminary results, that an acid tolerant, model sugar or sugar alcohol solution reforming catalyst has been synthesized.
- Future Work (pending funding)
  - Hydrolysis Work
    - Optimum hydrolysis conditions: Energy and Capital Cost
    - Hydrolysis product chemical composition and physical properties
    - Sugar identification and concentrations
    - Identification and quantification of low molecular weight organics
    - Solubility, average MW and surfactant/foaming properties of lignin fraction
  - Catalysis discovery and testing
  - Micro-scale continuous operation of membrane reformer with batch hydrolysis
    - ~500 hr catalyst performance test
    - Collection of material and heat balance data important for plant design
  - Final Economic and Energy Analysis for Final Report

# Biomass Hydrolysis and Reforming Processes

## Modeling Basis

- Dilute acid hydrolysis

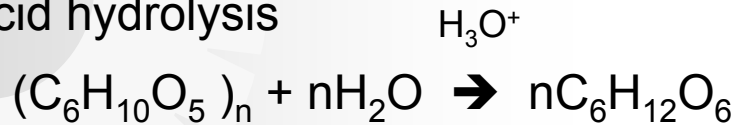

- Liquid phase reforming

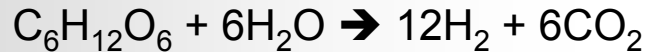

- H<sub>2</sub> separation

Pd membrane is used for H<sub>2</sub> separation

- Lignin combustion

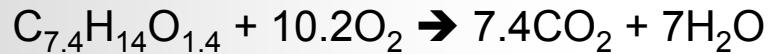

- Sulfur recovery

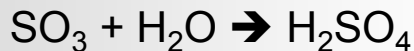

$$\text{LHV Energy Efficiency} = \frac{\text{LHV of product H}_2 + \text{Energy recovered} - \text{Energy consumed}}{\text{LHV of biomass feed}}$$

# Modeling and Simulation Assumptions

---

- An adiabatic efficiency: 75% for all rotating equipment.
- Heat losses: 4–5% of the heat load on heat exchangers.
- Energy consumption for biomass pretreatment: 1.8% of the biomass feed LHV.
- Pd alloy membrane selectivity of H<sub>2</sub>: 100%
- The biomass feedstock: 75% cellulose, hemicellulose or other oligimers, that could be converted to soluble, reformable oxygenates by the hydrolysis process. The balance, 25%, is lignin, C<sub>7.4</sub>H<sub>14</sub>O<sub>1.4</sub>.
- Two-stage dilute acid hydrolysis processes operated at temperatures between 190 °C and 215 °C.
- For modeling purposes only, all reformable oxygenates are “glucose”.
- For modeling purposes 95% “glucose” yield was considered to be only a function of temperature.
- In the baseline design, the yield of H<sub>2</sub> and CO<sub>2</sub> from glucose: 94% over the advanced high activity, high selectivity catalyst system.

# Block Flowsheet Diagram for Proposed Biomass Reforming Plant

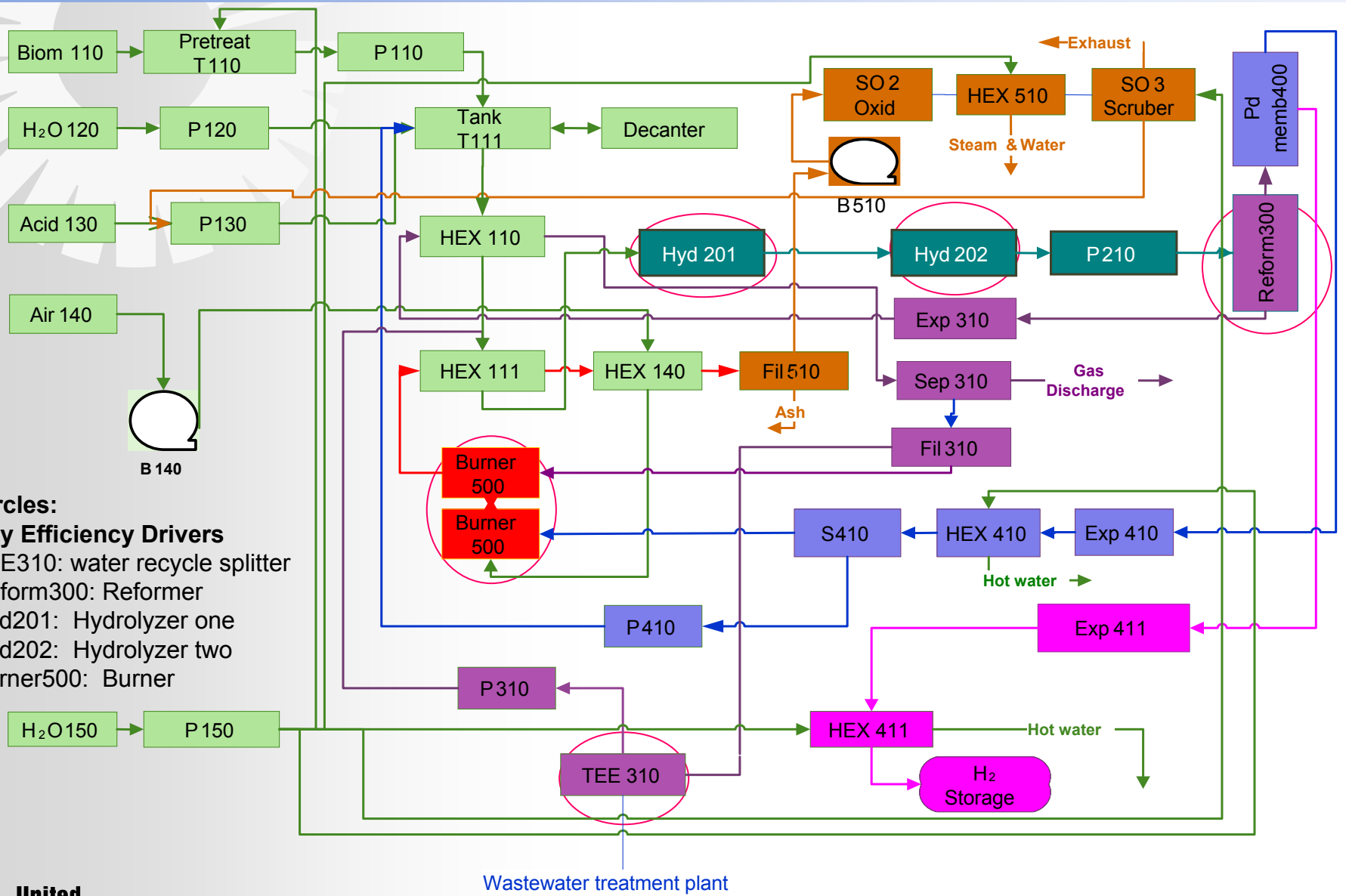

**Circles:**  
**Key Efficiency Drivers**  
 TEE310: water recycle splitter  
 Reform300: Reformer  
 Hyd201: Hydrolyzer one  
 Hyd202: Hydrolyzer two  
 Burner500: Burner

# Key Features of Proposed Biomass Reforming Plant

- Sulfur tolerant Pt-alloy rafts/nano-engineered mixed metal oxide catalysts will be developed for liquid phase oxygenates (sugar) reforming
- Lignin, byproduct fuel gas and unrecovered H<sub>2</sub> are burned to provide thermal energy thus increasing system efficiency.
- Recycling of the hot water used for hydrolysis increases system intensity.
- Sulfur recovery & recycle as H<sub>2</sub>SO<sub>4</sub> lowers costs and minimizes emissions
- 54.2% LHV energy efficiency (46.6% plant H<sub>2</sub> efficiency) achieved through comprehensive thermal integration

$$\text{Process Energy Efficiency} = \frac{\text{LHV of product H}_2 + \text{Energy Recovered}}{\text{LHV of biomass feed} + \text{Energy consumed}}$$

$$\text{Plant H}_2 \text{ Efficiency} = \frac{\text{LHV of Product H}_2}{\text{LHV of Biomass Feed} + \text{Energy Consumed}}$$

DOE H2A definitions

$$\text{LHV Energy Efficiency} = \frac{\text{LHV of product H}_2 + \text{Energy recovered} - \text{Energy consumed}}{\text{LHV of biomass feed}}$$

UTRC definition



# Biomass Reforming Plant HYSYS Flowsheet Used for Initial Optimization Through Parameter Sensitivity Studies

- 2000 ton(dry)/day biomass feed

Reactant Table	
Total mass flow, kg/day	1.95e+007
H2SO4 conc. mol/L	0.121
Mass Frac (Cellulose*)	8.265e-002
Mass Frac (Lignin*)	2.129e-002
Mass Frac (H2O)	0.880

Summary	
LHV Energy Efficiency	54.20 %
Plant Hydrogen Efficiency	46.6 %
H2 Recovery	90.0 %

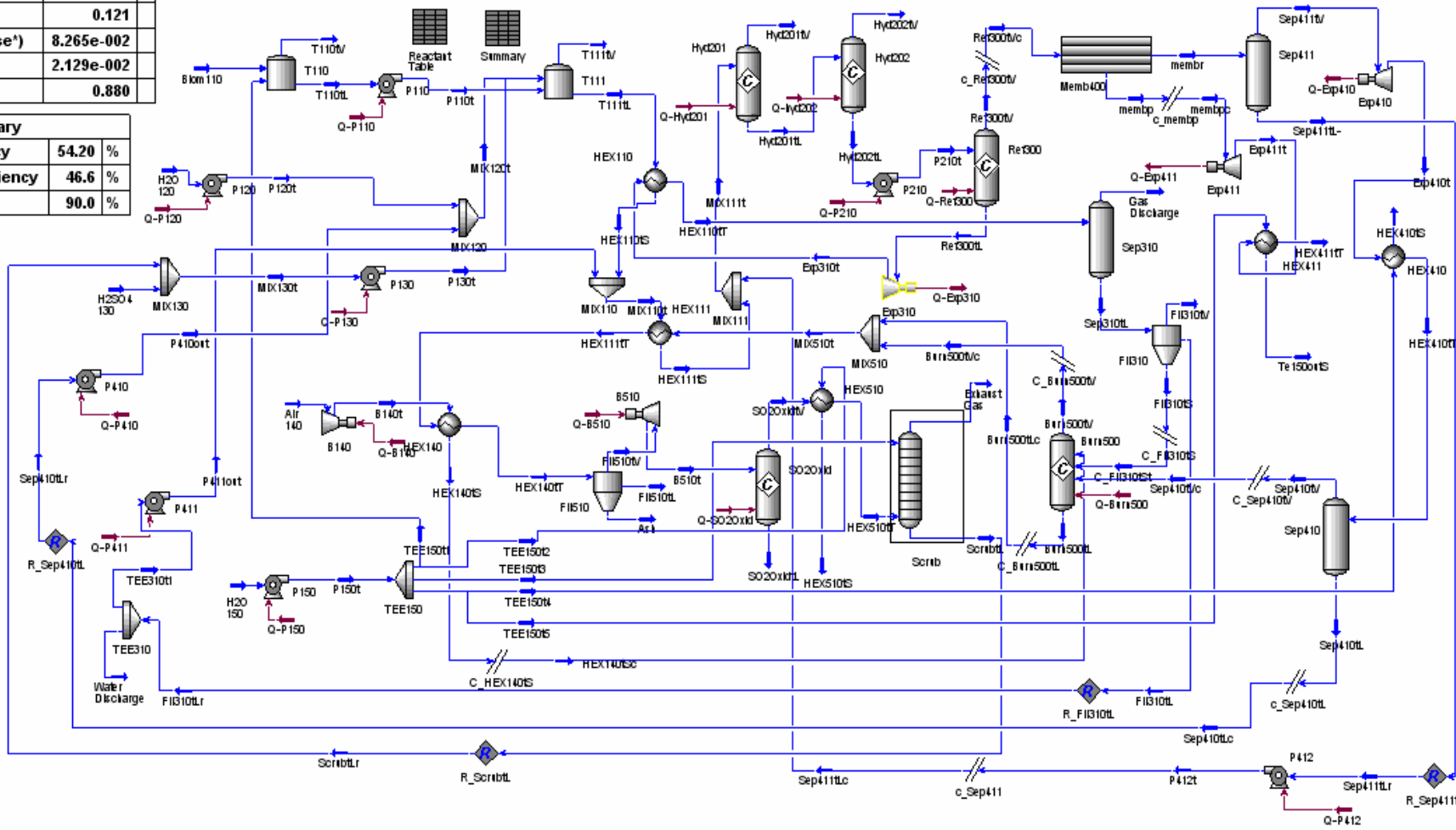

# Parameter Sensitivity Studies, One Parameter Varied & Others Held Fixed: Out of 40, 2 Were Very Important & 7 Important

- Two of the most important:
  - TEE 310 process water splitter recycle affects strongly the efficiency:
    - Most of energy goes into heating water,
    - At given water input, increased recycling dilutes the system, requiring more energy
  - Increasing combustion of unconverted biomass increases plant energy recovery

**TEE 310 Water Fraction To Recycle**

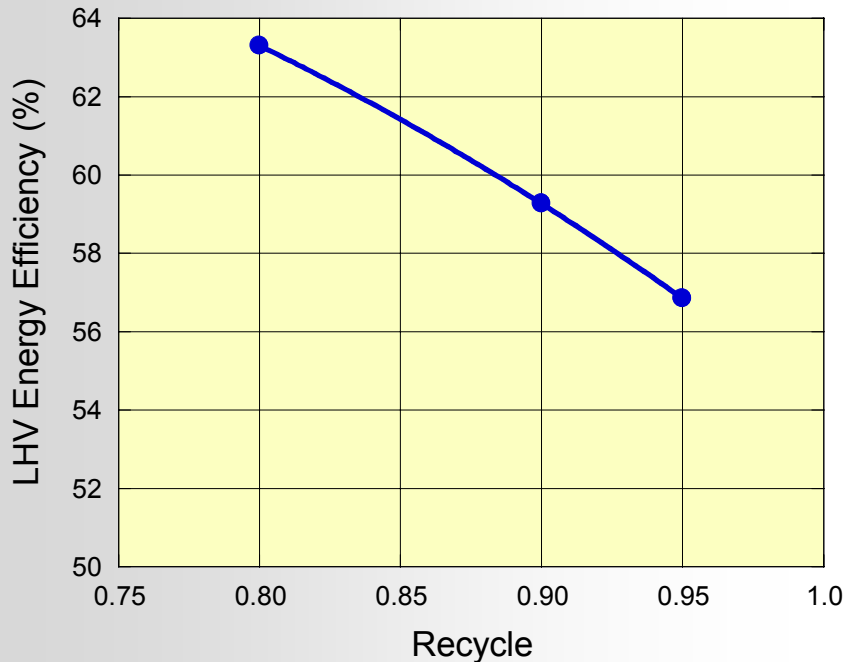

**Lignin Combustion Conversion**

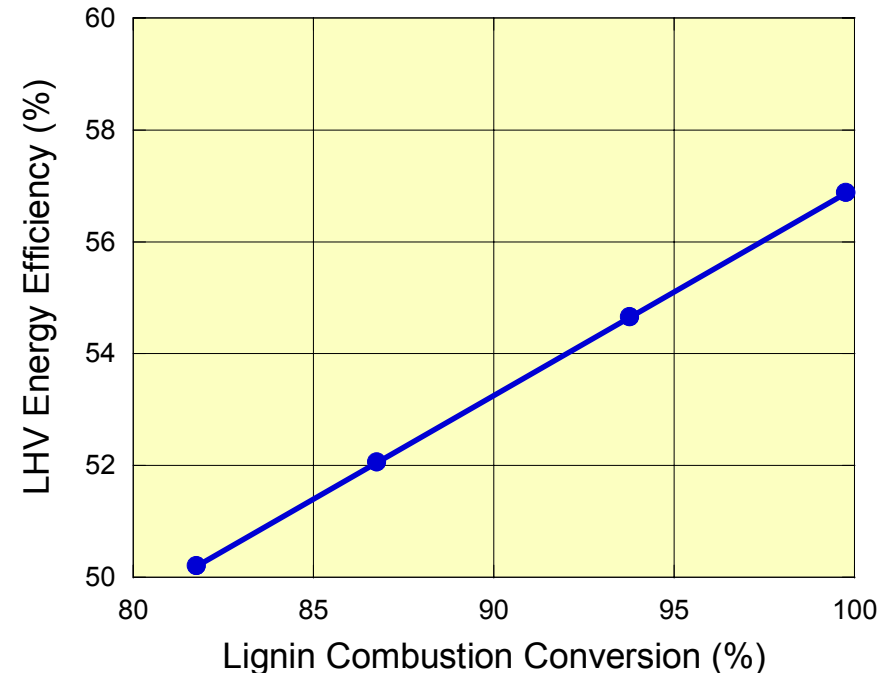

# Parameter Sensitivity Studies 2 : Efficiency Increases with Reformer Pressure & Lower SO<sub>2</sub> Oxidation Temp.

- Increase of reformer pressure is limited by Capital Cost & Chemistry
- SO<sub>2</sub> oxidation temperature has negative impact on the efficiency

### SO<sub>2</sub> Oxidation Temperature

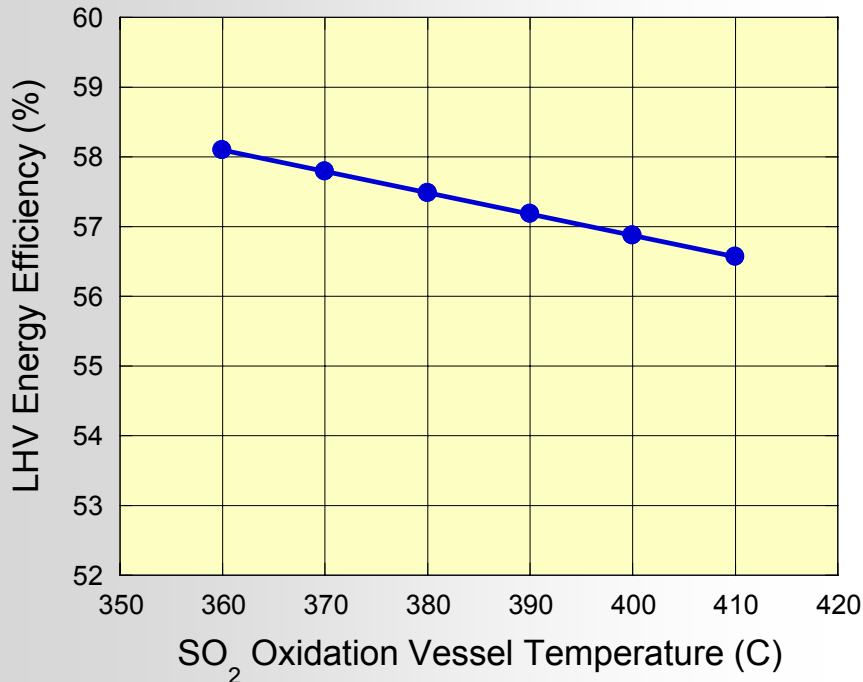

### Reformer Pressure

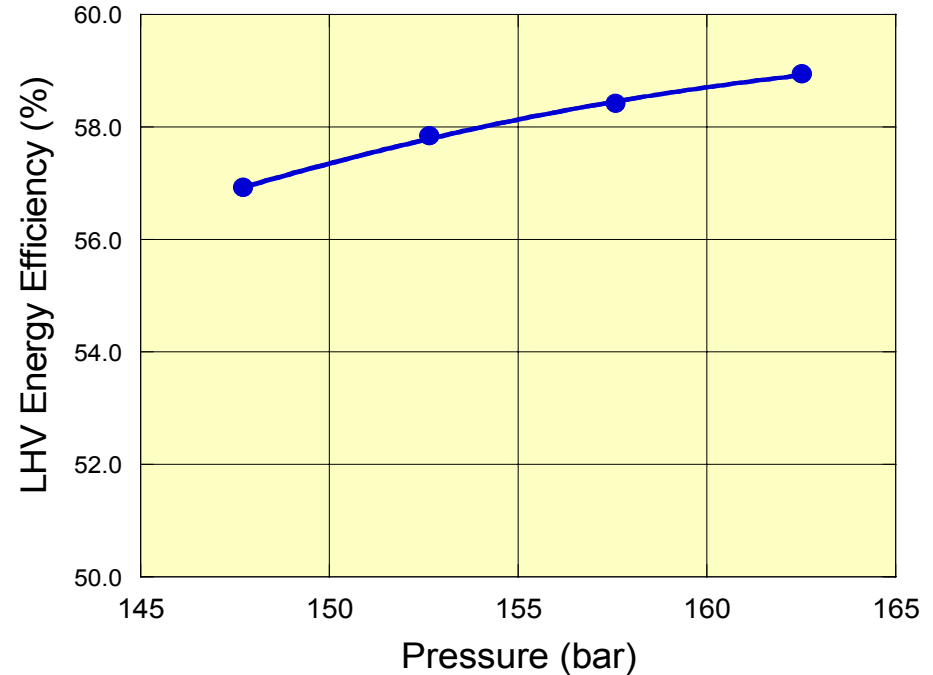

# Major Drivers for LHV Energy Efficiency

Several parameters have been identified to have strong impact on system efficiency. For example, Lignin combustion in the burner provides thermal energy to the system.

Tee310 splitter recycles hot process water. System efficiency increases with decreased hot water recycle.

Parameter	Impact on Efficiency
Hydrolysis Stage One Temperature	++
Hydrolysis Stage Two Temperature	++
Reformer Pressure	++
Reformer Glucose Conv. To H <sub>2</sub>	++
Reformer Glucose Conv. To CH <sub>4</sub>	++
SO <sub>2</sub> Oxid Vessel Temperature	--
Burner Temperature	+
Burner Lignin Combustion	+++
Tee310 Flow Ratio (H <sub>2</sub> O recycle)	+++

- + slightly positive impact
- ++ positive impact
- +++ very positive impact
- Negative impact

# Design of Experiments

---

- Statistical Design of Experiments.
  - 9 factors
  - 61 experiments
  - 5 replicates used to measure/check computational/round off errors
  - Modified central composite design for response surface study
- 61 cases were generated and run by using HYSYS.
- Effects of multi parameters on the system efficiency were obtained.
- 2-D and 3-D response surface maps were created from the Design of Experiments results.
- Operating region for achieving greater than 50% efficiency was identified from 2-D and 3-D maps.

# Reformer conversion drives system efficiency

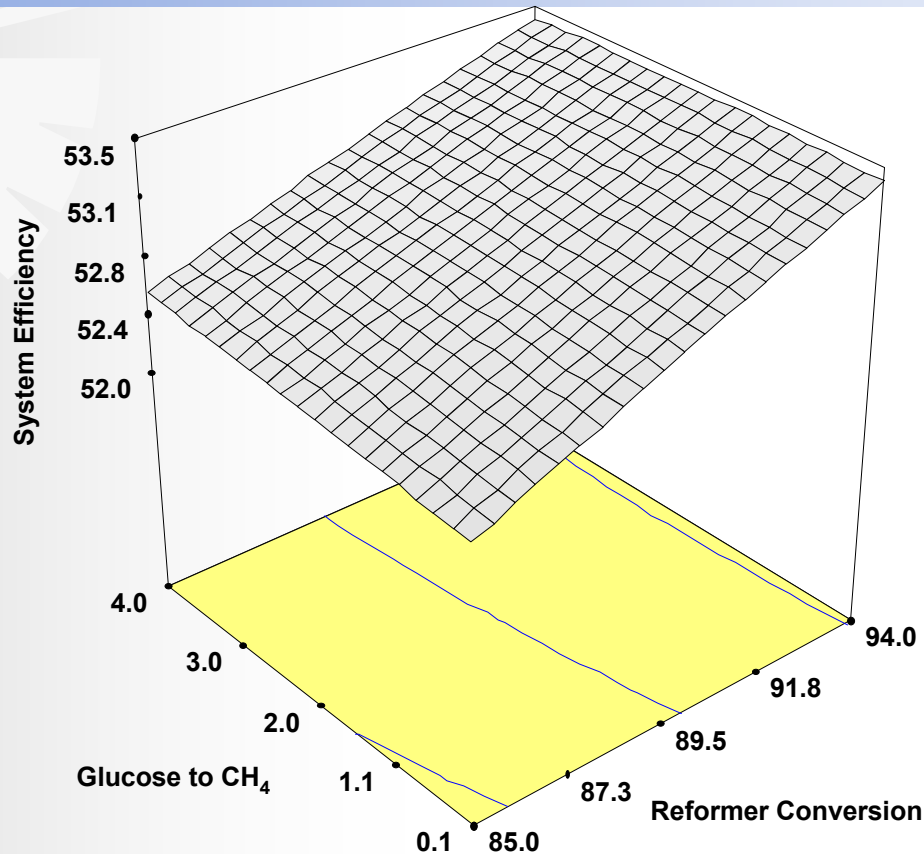

- Conversion of sugars to methane has a positive effect on efficiency
- Methane combustion provides plant energy

# Higher pressure & optimal H<sub>2</sub>O recycle boosts efficiency

- LHV energy efficiency > 52% at reformer pressures >147 bar
- At given water input, increased recycling dilutes the system, requiring more energy

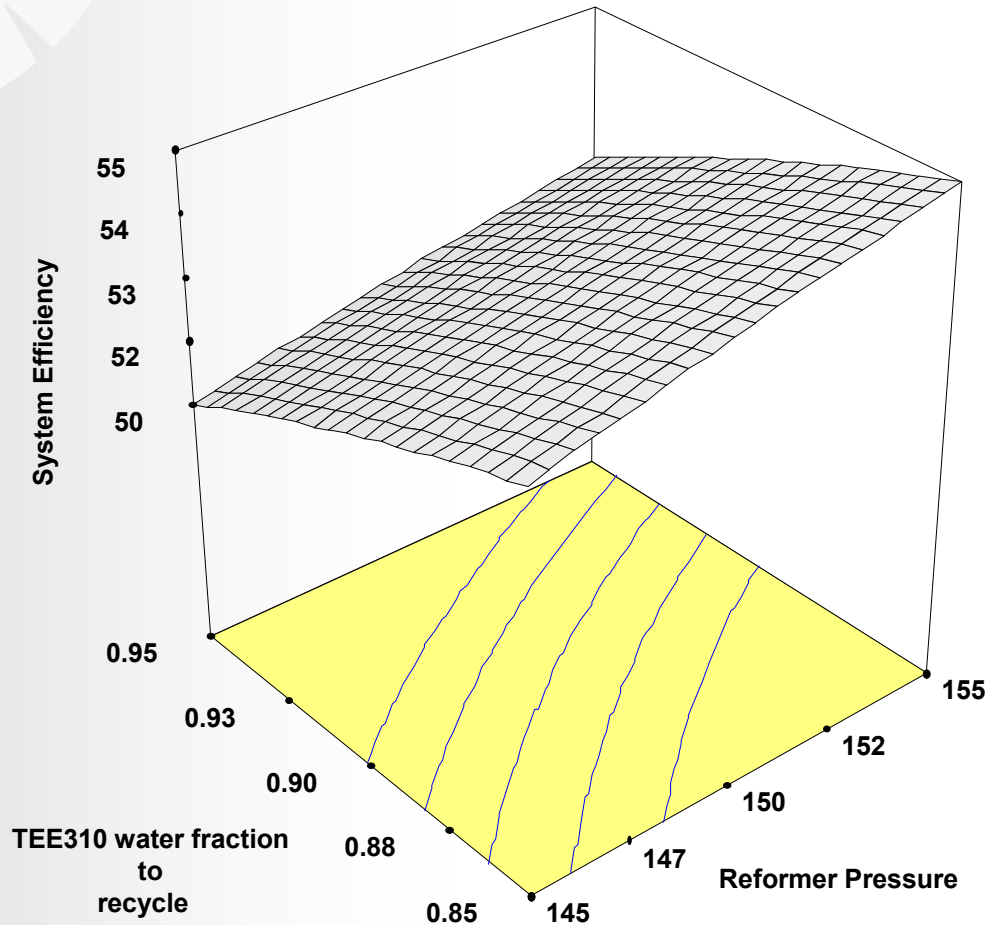

# Lignin combustion, system pressure, & hydrolysis conditions have a strong effect on efficiency

- >50% LHV efficiency can be achieved when the lignin combustion/heat recovery exceeds 85% and the temperature of hydrolyzer 1 is greater than 170 °C

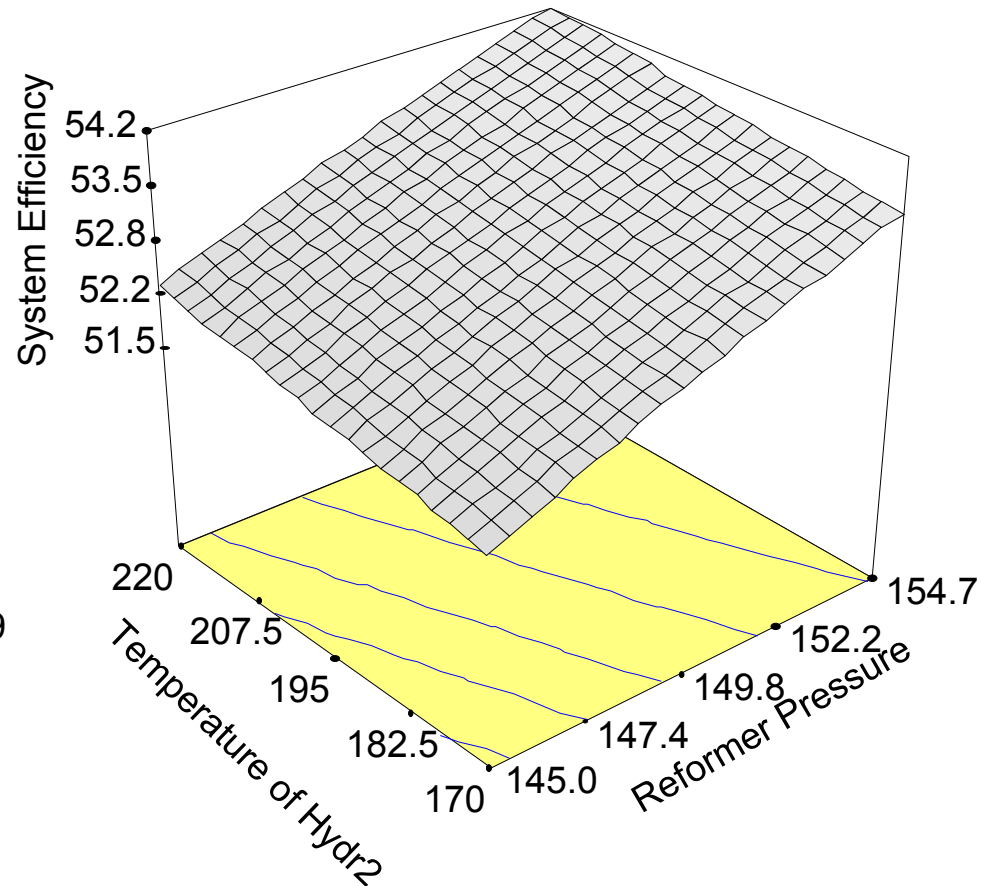
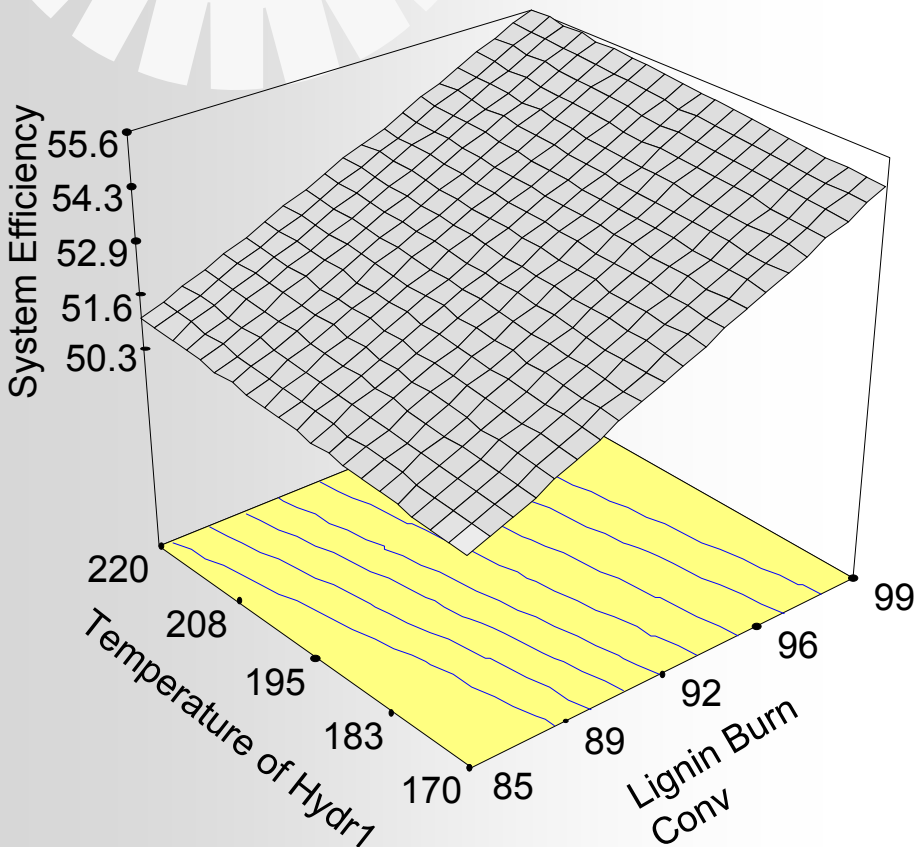



# Preliminary economics on baseline plant design

## **DCF CALCULATION OUTPUTS:**

Required Hydrogen Selling Price (Year 2005 Real Dollars/kg)	\$1.581
Required Hydrogen Selling Price (Start-up Year (Nominal) Dollars/kg)	\$1.581
After Tax Real IRR	10.0%
Pre Tax Real IRR	14.0%
After Tax Nominal IRR	12.1%
Pre Tax Nominal IRR	16.2%
After Tax Real Capital Recovery Factor	0.102
After Tax Nominal Capital Recovery Factor	0.122
Total Real Fixed Charge Rate	0.139
Total Nominal Fixed Charge Rate	0.170
NPV	\$0

# Major H<sub>2</sub> Selling Price Drivers Are Capital, Other Raw Material, and Feedstock Costs

## Category Cost Contributions

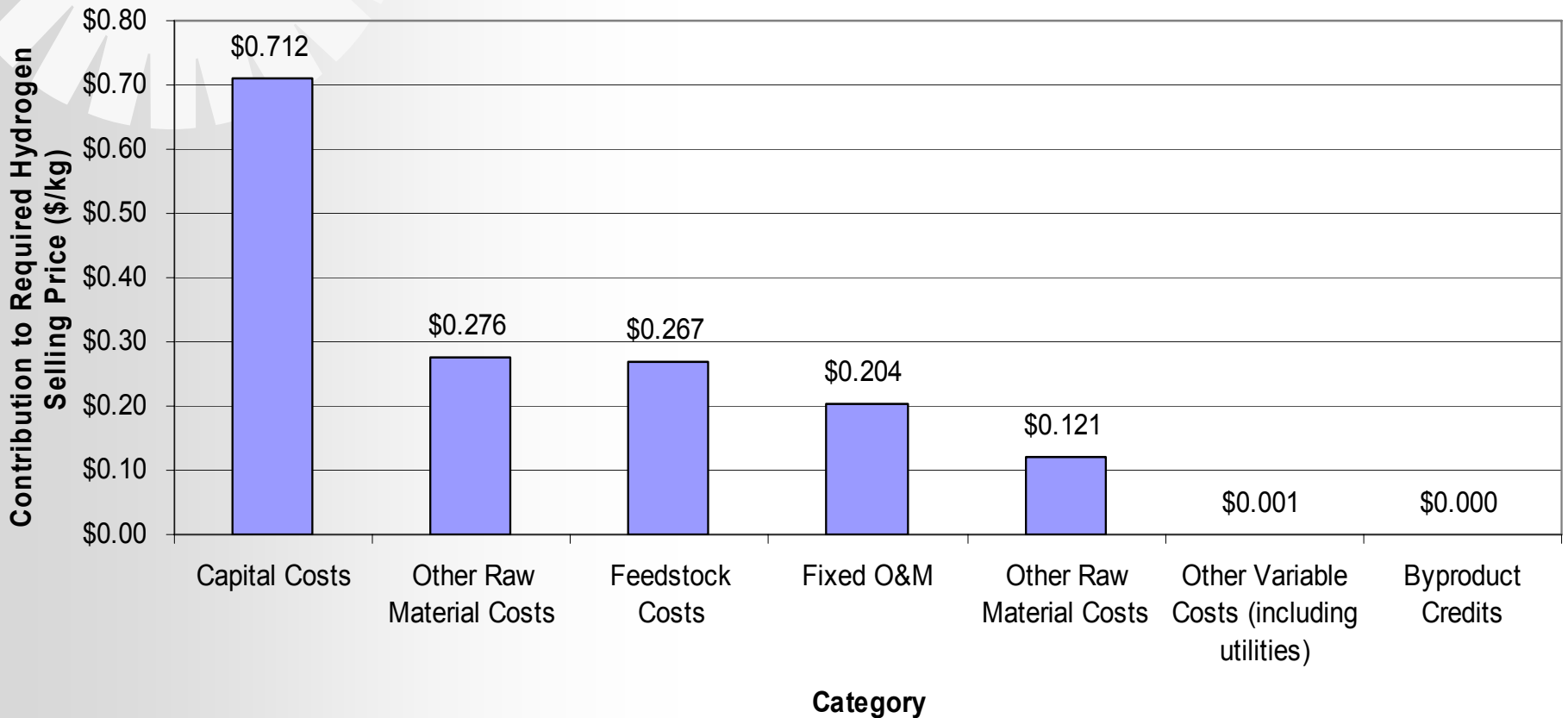

# Preliminary economics on baseline plant design(3)

## Sensitivity Analysis of Biomass Gasification to Hydrogen

Biomass Feedstock Cost (base case = \$21.86/ton)

LHV Energy Efficiency (base case = 54.4%)

Labor Requirements (base case = 54 FTE)

Capacity Factor (base case = 90%)

Total Capital Investment (base case = \$280.55 million)

Base Case = \$1.58/kg

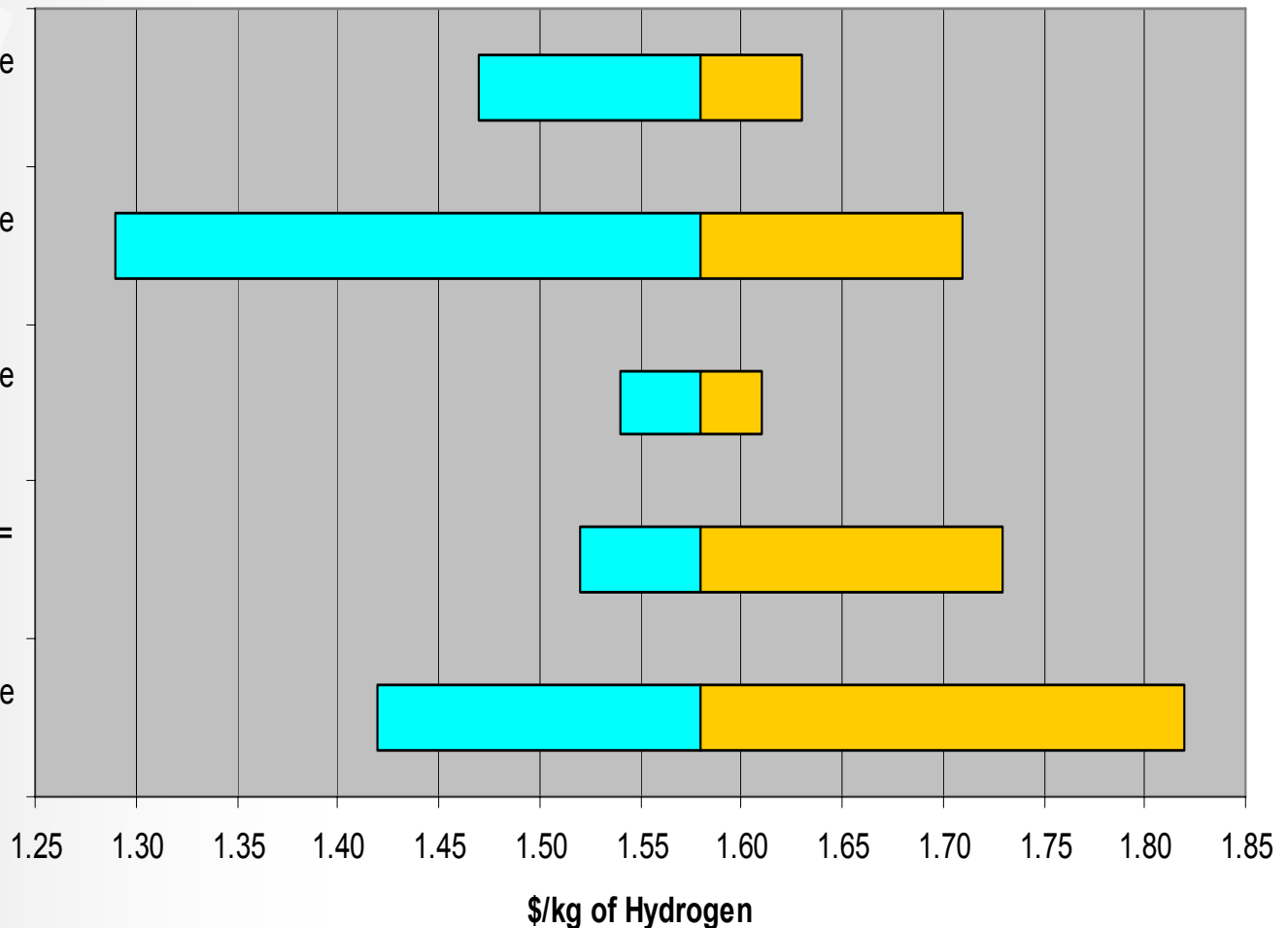

# Summary

---

- Biomass reforming plant design with a system HYSYS simulation LHV efficiency of 54% is proposed.
- The thermally integrated design yields high efficiency and minimizes sulfur emissions.
- Major drivers on the efficiency were identified in parameter sensitivity studies.
- > 50% LHV efficiency operating regime identified through DOE studies.
- Hydrolysis and reforming catalyst/reactor performance targets identified.
- Hydrogen production cost of \$1.60/kg H<sub>2</sub> is achievable with this process.

# Future Work

---

- (2Q2007) Illustrate, through an initial feasibility analysis on a 2000 ton/day (dry) biomass plant design, that there is a viable technico-economical path towards the DOE's 2012 efficiency target (43% LHV) and assess the requirements for meeting the DOE's cost target (\$1.60/kg H<sub>2</sub>).
- (3Q2007) Demonstrate, through preliminary results, that an acid tolerant, model sugar or sugar alcohol solution reforming catalyst has been synthesized.
- Pending future funding, hydrolysis optimization; additional catalyst development, including atomistic modeling; and a 1-kW scale demonstration and final techno-economic analysis at the end of the project.

# UTRC Catalyst Discovery Approach

*Atomistic catalyst design, synthesis, characterization, reaction studies & kinetic analysis*

## Conceptual Catalyst Design

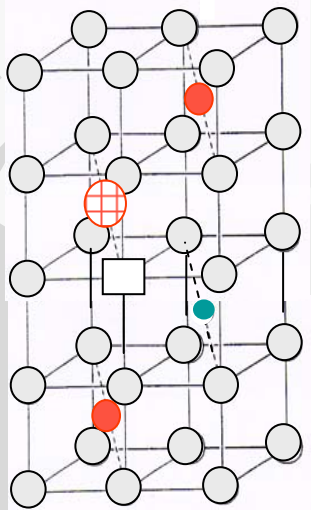

## Catalyst Synthesis

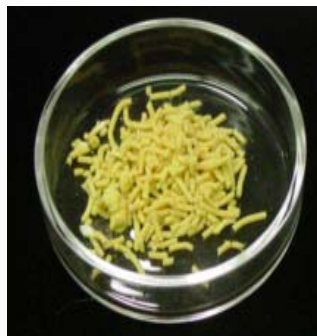

High active surface area  
Nanocrystalline structure  
~100% NM dispersion



## Quantum Mechanical Atomistic Modeling for advanced catalyst design

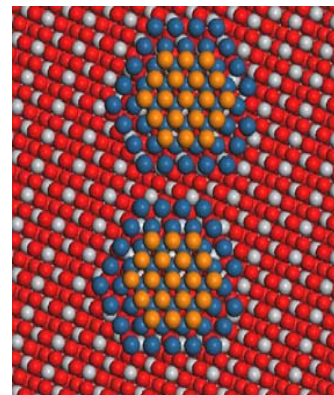

## Characterization

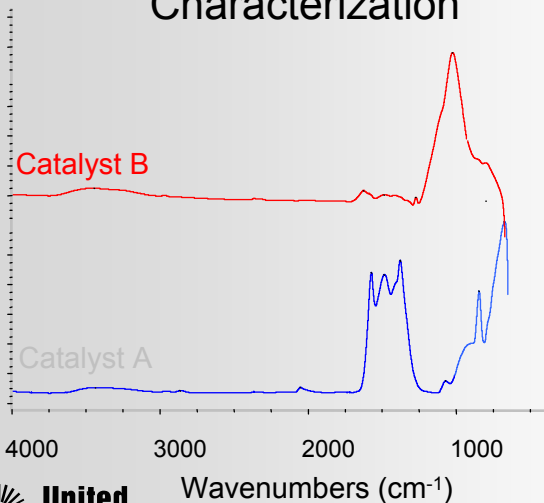

## Kinetic Expressions Derived From Reaction Data

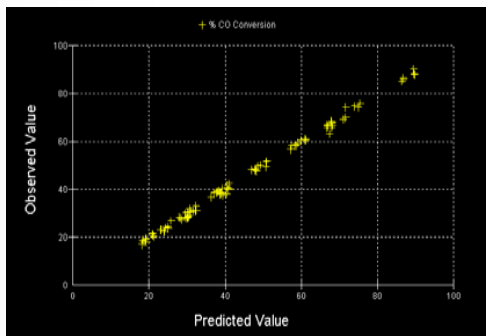

## Superior Performance

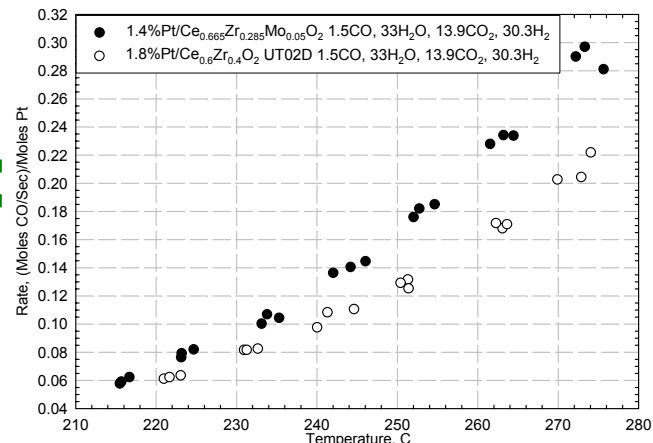

# Laboratory Capabilities for Catalyst Development

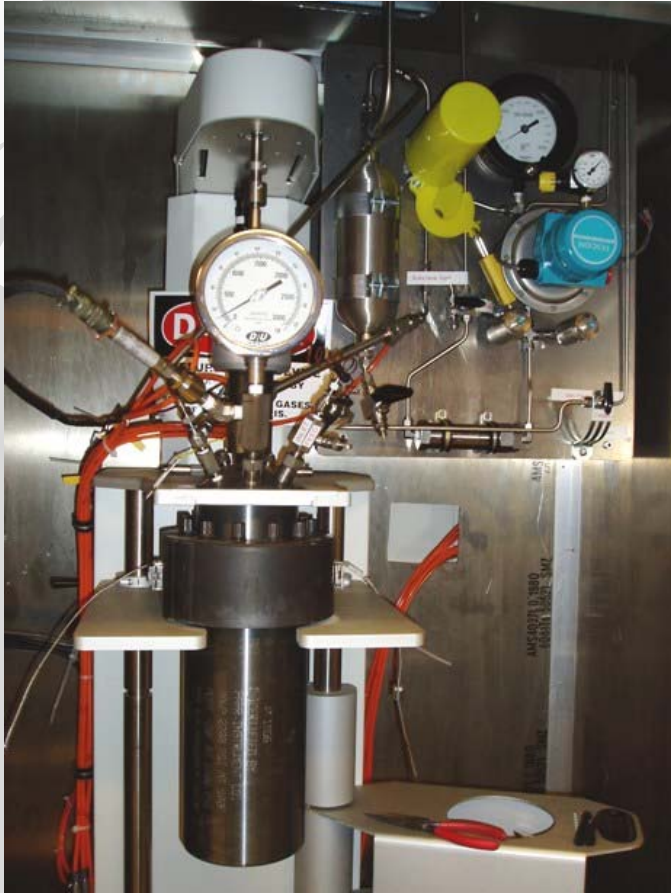

Autoclave for  
Hydrolysis /  
Reforming

Biomass Test Rig – reforming of  
cellulose and hemicellulose  
materials to form  $H_2$  and  $CO_2$

