

Membrane Applications for Nuclear Hydrogen Production Processes

*Brian L. Bischoff, Dane F. Wilson, Lawrence E. Powell,
and K. Dale Adcock*

Oak Ridge National Laboratory*

P.O. Box 4699, Oak Ridge, TN 37831

Tel: 865-241-3172, Fax: 865-576-3502, Email: bischoffbl@ornl.gov

Presented at

**DOE Hydrogen Program Annual Review
Crystal City, VA**

**May 15-17, 2007
Project #PDP25**

*This research was sponsored by the Laboratory Directed Research and Development Program of Oak Ridge National Laboratory, managed by UT-Battelle, LLC, for the U.S. Department of Energy under Contract No. DE-AC05-00OR22725. Accordingly, the U.S. Government retains a nonexclusive, royalty-free license to publish or reproduce the published form of this contribution, or allow others to do so, for U.S. Government purposes.

This presentation does not contain any proprietary or confidential information

Project Overview

Budget (\$K)

	Sulfur Cycles	High Temperature Electrolysis
FY2006	380	100
FY2007	300	60

Partners and Collaborators

- General Atomics
- Idaho Falls National Laboratory

Objectives

Sulfur Cycles

To assess the potential for high temperature inorganic membranes for use in the decomposition of sulfuric acid.

- Evaluate stability of membrane materials in the corrosive SO_2/SO_3 environment.
- Fabricate membranes from compatible materials and initiate testing of membrane separation efficiency.

HTE

To analyze the applicability of high temperature inorganic membranes, developed at ORNL, for the separation of hydrogen from steam at the outlet conditions of the solid oxide electrolyzer cells.

Approach

Sulfur Cycles

The primary tasks are:

- 1) - Identification of candidate high temperature membrane materials
- 2) - Candidate membrane and support tube fabrication studies
- 3) - Membrane and support tube materials compatibility testing
- 4) - Conduct membrane separations tests

These initial studies will provide basis and initial separations for prioritizing further investigations on membrane materials for the high temperature step in the Sulfur cycles.

High Temperature Electrolysis

- 1) Test ORNL inorganic membranes for the separation of hydrogen from steam at electrolyzer conditions for extended period of time.

ORNL's Inorganic Membrane Fabrication Process is Quite Versatile

- Pore diameters of 0.5 nm – 20,000 nm; for H₂, pore diameters of <1 nm are preferred
- Tubular support structure and layer made of variety of metals and ceramics
- Excellent mechanical, thermal, and chemical stability
- Membrane layer(s) applied to inside of support tube
- Membrane layer thickness of 2 μm or less yields high gas flows at low pressure drop; small pores result in high selectivity
- Proven scalability



A Thin Separation Layer Allows High Flow of Gases Through Small Pore Membranes

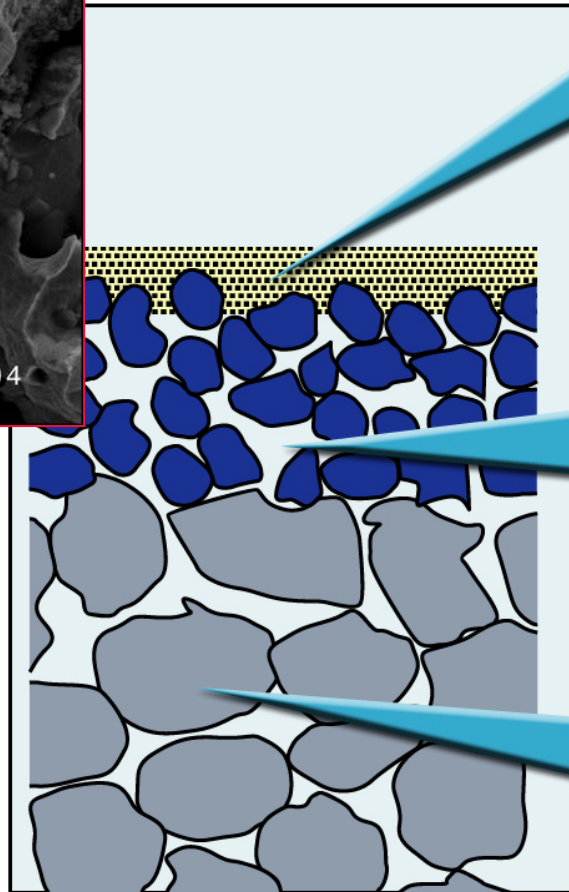
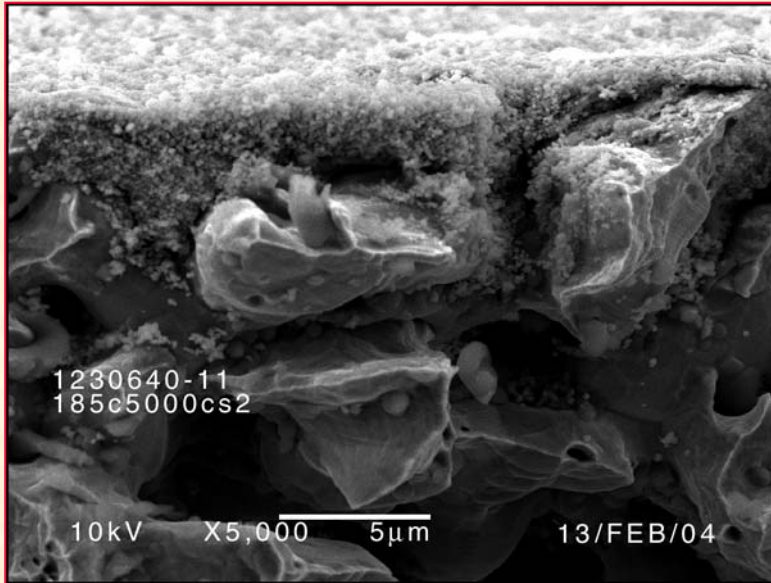

Critical Membrane Layer

Pore Size: 0.4-5 nm
Thickness: 0.01-0.5 μ m

Primary Layer

Pore Size: 0.005-0.5 μ m
Thickness: 1-20 μ m

Porous Support

Pore Size: 0.5-50 μ m
Thickness: >400 μ m

In Distinct Contrast To Palladium Or Ion Transport Membranes, These Are Porous

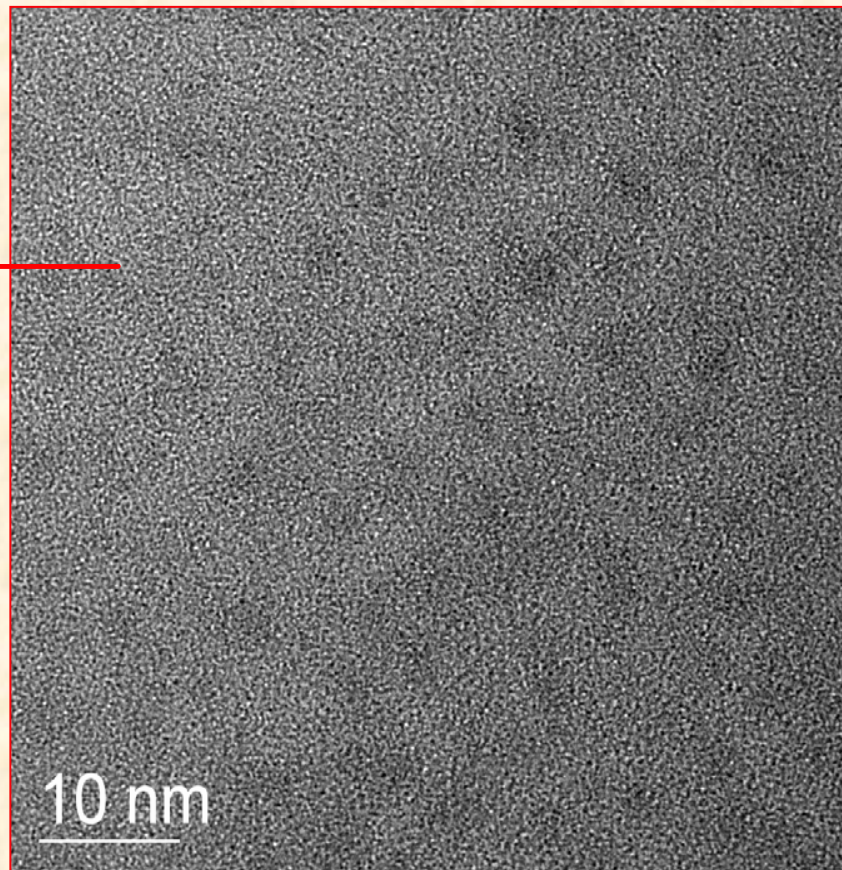
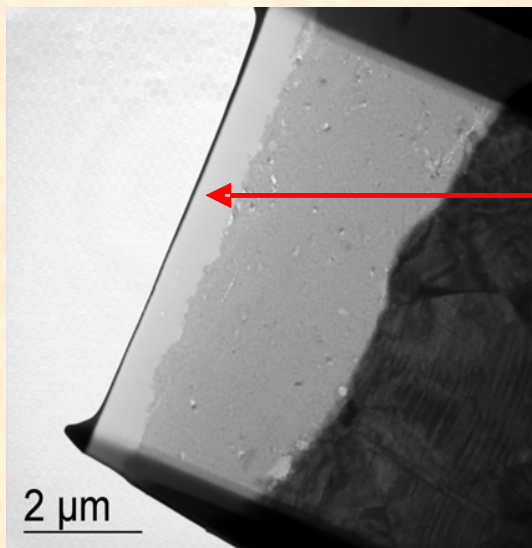

Membranes are descriptively nanoporous with pore sizes < 2 nm, but IUPAC nomenclature is 'microporous' (I didn't make the rules)

Thermochemical Cycles can be Used to Produce Hydrogen from Water

- **Water + Heat \Rightarrow Hydrogen + Oxygen**
- **Sulfur-based thermochemical cycles are the leading options**
- **Sulfur cycles require very high temperatures (850°C)**
 - **At the limits of reactor technology**
 - **At the limits of practical materials**
 - **Large incentives exist to reduce temperatures**
- **A method to lower peak temperatures by 100 to 200°C is being developed using inorganic membranes**

Sulfur Family of Thermochemical Cycles

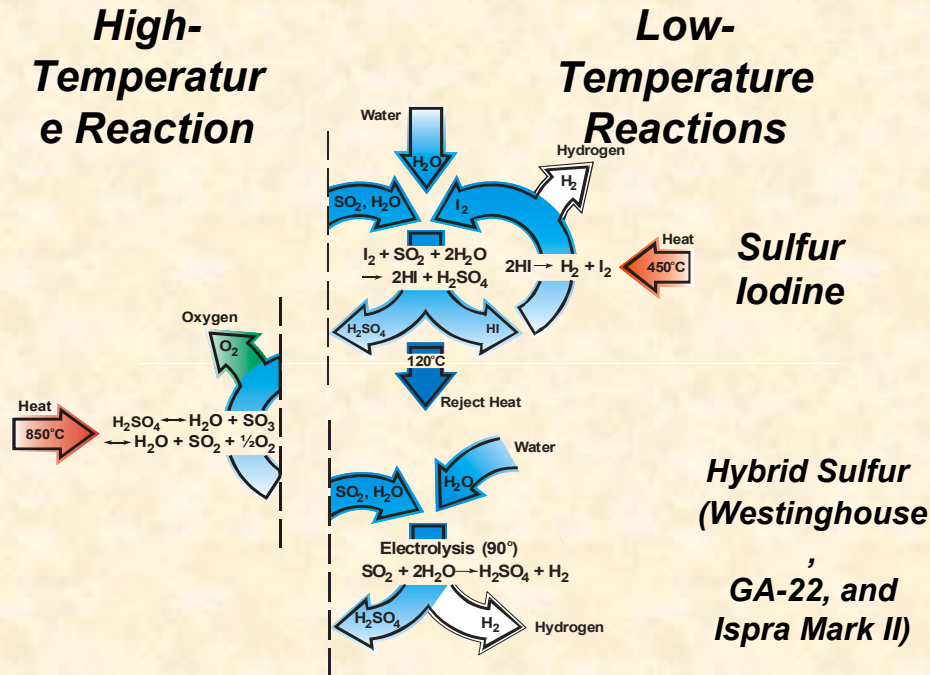

- Shift the equilibrium of the high-temperature reaction to completion by removing the reaction products using inorganic membrane

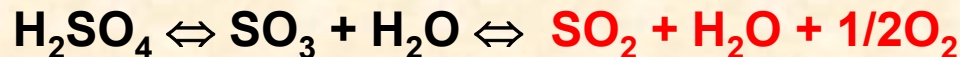

- Membrane separation of O_2 , H_2O , and SO_2 from SO_3 drives reaction to the right, thus allowing high conversion at lower reaction temperatures
- Potential exists to reduce peak temperature to between 650 and 750°C

Experimental Test Facility

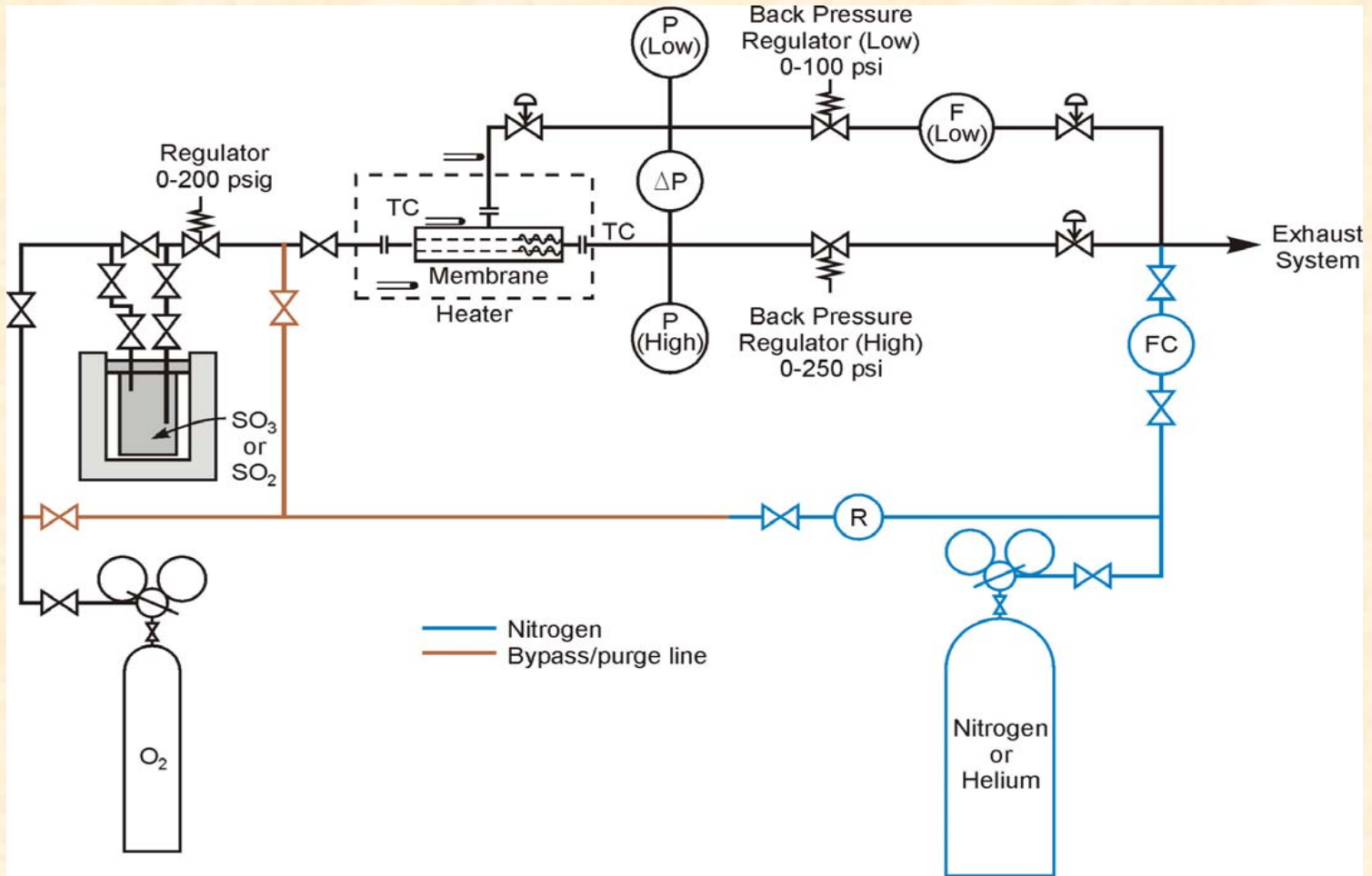

1st Generation Membrane Tests: SO₂/SO₃ and O₂/SO₃ Separation Factors Exceed 2 in Low-Temperature Tests

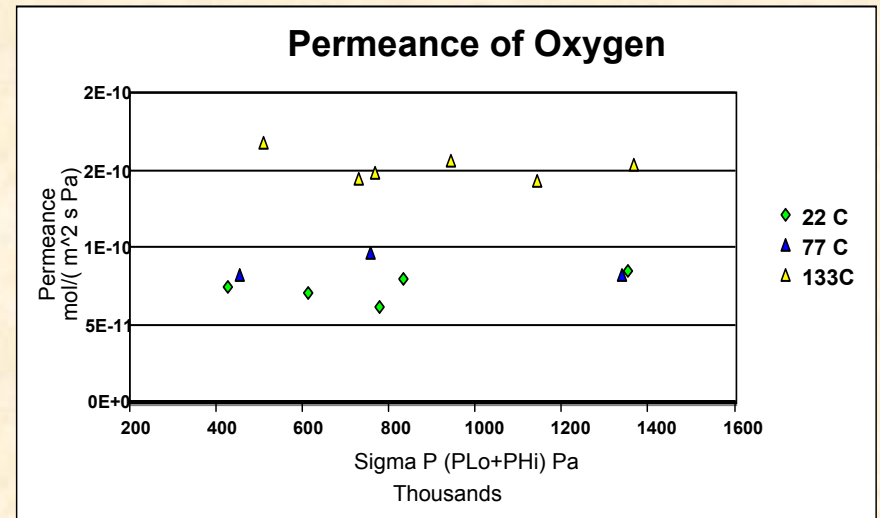
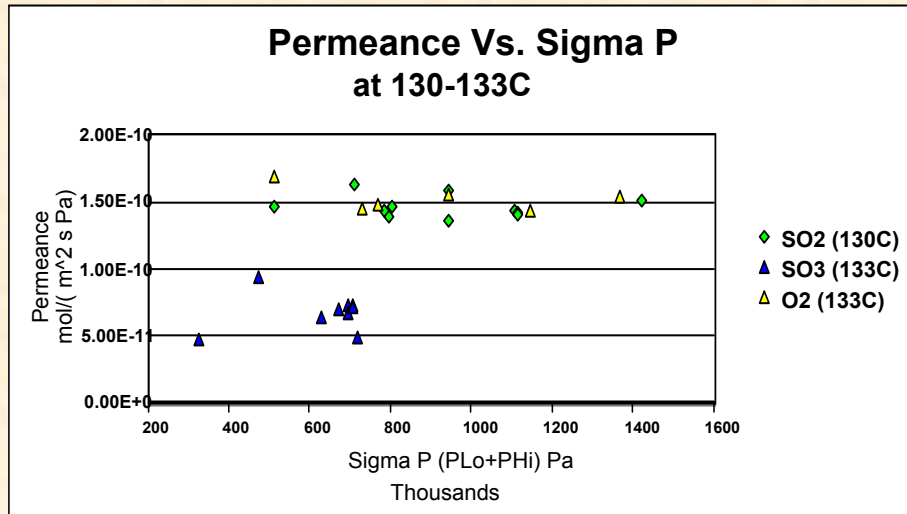

Oxygen Data Shows Flow Through Membrane Increases with Temperature: Indicative of Desirable Thermally-Activated Diffusion. This Thermally-Activated Diffusion will Result in Higher Permeance and Higher Separation Factors at Higher Temperatures

Initial Support Materials Selection

The following materials were originally identified as potential candidates for support tube fabrication. Coupon samples (1") were fabricated for environmental testing.

- 1) Hastelloy B2 or B3
- 2) Hastelloy C22
- 3) Hastelloy G
- 4) Monel
- 5) MA20Nb-3
- 6) MA825
- 7) Nickel-Copper alloy

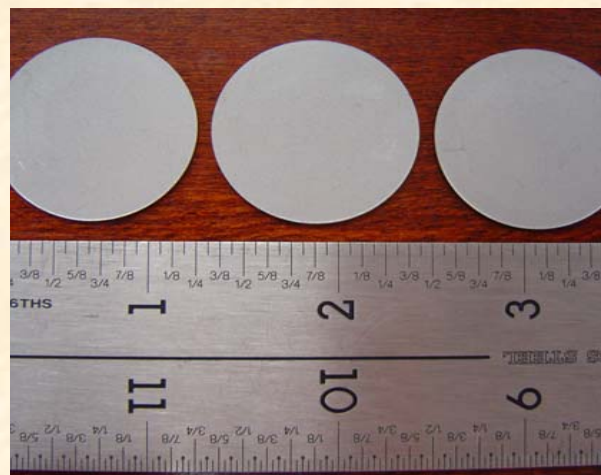

While these materials may contain elements that form low melting sulfur compounds, they will allow for the determination of reaction products and morphologies that guide the selection and development of materials that can survive in the environment

Exposure Test System Has been Modified Several Times

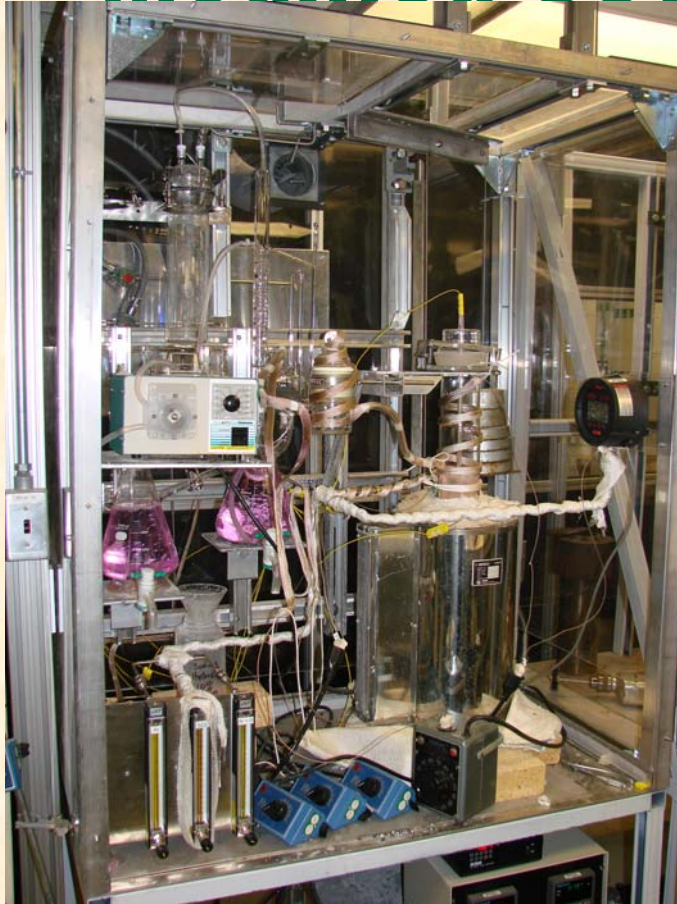

The scrubber system for the effluent gas caused problems and was extensively redesigned. It now incorporates a drip tip within the scrubber, near the gas inlet region, to avoid bubble formation, and an accumulator between the gas inlet to the scrubber and the reaction vessel to collect any liquid that may flow backwards to the reaction vessel.

C-22 Was Found to Not Be Very Stable at 500°C

❖ At 500°C for 168 h in 3:1
SO₂:O₂

- 21.85 mg/cm²
 - Very fast rate
- Elemental cross-sectional analyses are on-going
 - Significant attack across cross-section of specimens

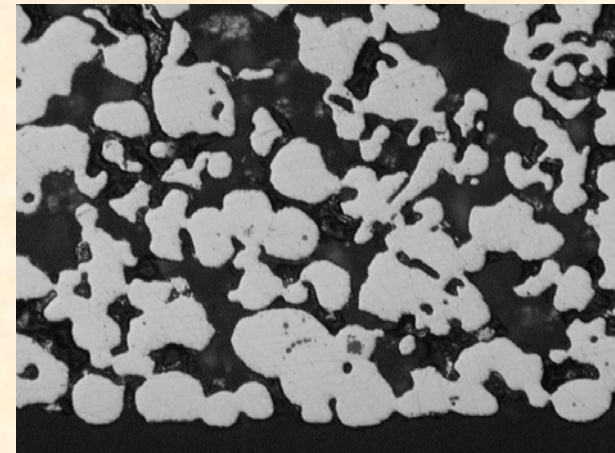
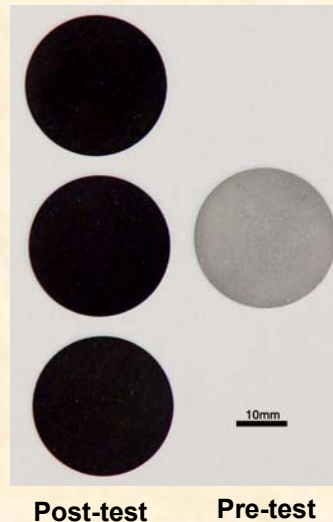

06-0390-08 C-22 Unexposed 500x 10µm
As polished

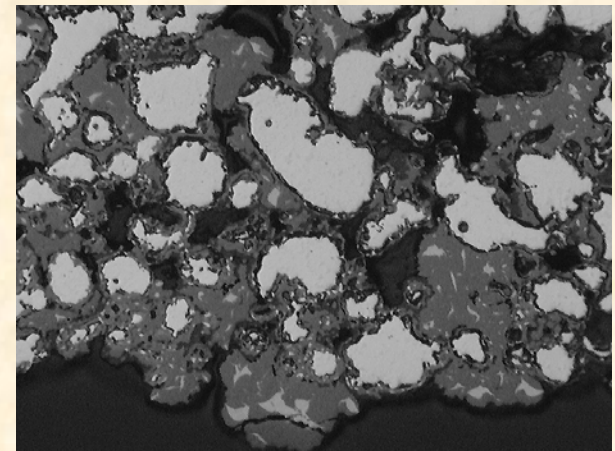

06-0392-08 C-22-2 Middle Post-test 500x 10µm
As polished

Monel Samples Did Not Fare As Well in Exposure System

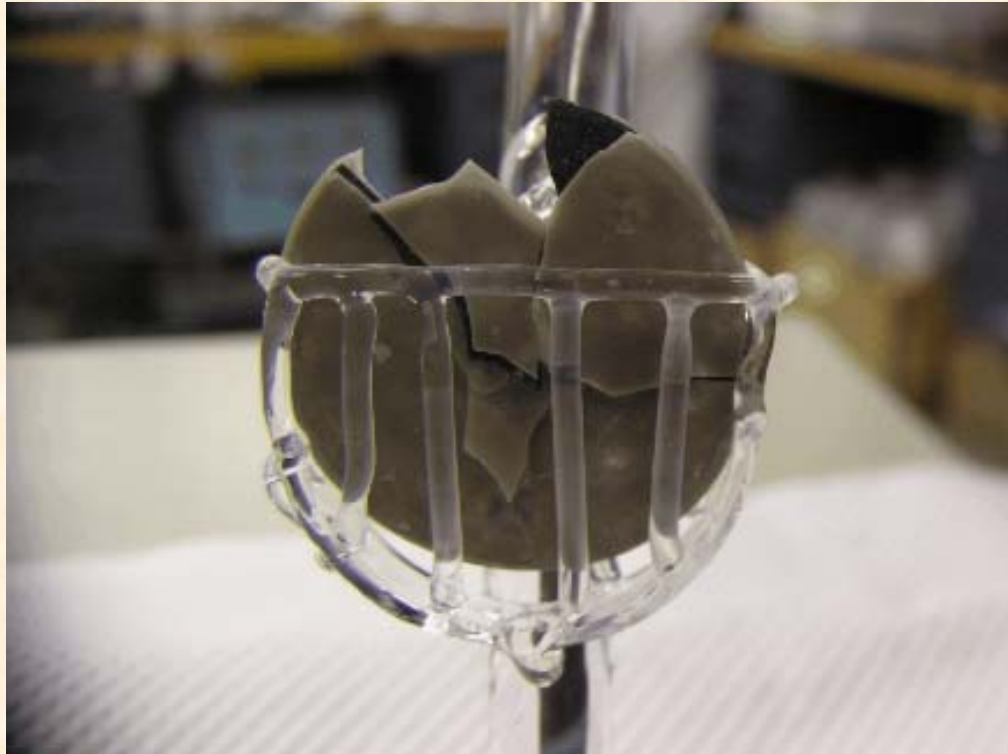

Typical cracked appearance of reacted Monel specimens after 25 h at 550°C.

Where Do We Go From Here

- Initial tests of porous metal supports demonstrated difficulty in employing commercial alloys for support tube material. It is believed that specialty alloys could be developed with more research.
- Based on ORNL's tests and Sandia's decision to build reactor out of silicon carbide (SiC), it was decided to change focus to employing SiC as support material for membrane application.



Commercial porous support tube made by W. Haldenwanger. Tube is thicker and has larger pore size than desired.

- Titanium dioxide has shown good stability at INL as a catalyst support and is being studied as another potential membrane support.

Preliminary Results for SiC Supports

- Ring specimens of SiC were cut from commercial tube. Three specimens, after measuring and weighing, were exposed to the sulfur dioxide and argon-oxygen gases at 550°C for 168 hours. These same exposure conditions were used for the initial metal tests.
- The SiC specimens showed excellent compatibility with the reaction gases. Weight gains averaged 0.14 mg/cm², which is significantly lower compared to the metal alloys tested previously. The weight gain corresponds to a rate of $9.6 \times 10^{-9} \text{ mgcm}^{-2}\text{S}^{-1}$. The material also show dimensional stability and did not appear to increase in brittleness.
- Testing at 900 °C is on-going.
- Fabrication studies of SiC look very promising. Powder in the desired particle size was obtained and coupon-sized samples were formed and sintered at 1540°C, the furnace temperature limit in our laboratory. The samples were relatively strong and porous. We have located several furnaces at ORNL to complete final sintering at 1900-2100°C. Optimized SiC support tubes can be fabricated at ORNL with minimal equipment investment.

Preliminary Results for TiO₂ Supports

- Titanium dioxide in the desired particle size was procured and coupon samples were prepared and sintered at 1450 to 1500°C. These samples had the desired strength and pore size to be used for membrane support.
- The TiO₂ coupon samples are scheduled to be tested in the environmental test system in June 2007.
- TiO₂ has the advantage of being easier to process and requires lower sintering temperatures. However, TiO₂ is not as tough as SiC and may be more prone to catastrophic failures than SiC or metal supports.

Plan for the Remaining FY

- Complete stability tests of porous SiC at 900°C.
- Complete stability tests of porous TiO₂.
- Apply membrane separation layers to commercial porous support.
- Install membrane into tests system and begin separation tests.
- Begin stability tests of completed SiC supported membranes.



High Temperature Electrolysis

Outlet of electrolyzer

H₂ - 75-85 % with the balance steam at 600-900 °C and 1-5 MPa

Target is for membrane to produce hydrogen at 90-95% purity

Reject stream will be fed back into electrolyzer

Hydrogen is larger than Water molecule so separation cannot be accomplished by molecular sieving. Separation by Knudsen diffusion is

$$SF = \left(\frac{M_{Water}}{M_{Hydrogen}} \right)^{1/2} = 3$$

Operating Conditions for Electrolyzer Membrane System

Operating temperature in electrolyzer	750-900 °C
Pressure exiting electrolyzer	1-5 MPa
Temperature of stream entering membrane	600-800 °C
Concentration of hydrogen exiting the electrolyzer	75-85%
Concentration of hydrogen permeating through membrane	95-99%
Raffinate (reject) stream hydrogen concentration	20-50%

Reject stream is sent back to feed of electrolyzer at temperature

High Temperature Electrolysis

Measured Separation Factor (SF)

$$\text{SF} = (\text{Conc. H}_2 \text{ out}/\text{Conc. H}_2 \text{ in})/(\text{Conc. H}_2\text{O out}/\text{Conc. H}_2\text{O in})$$

For 75% H₂ One Stage Conc. H₂ = 90%

Two Stages Conc. H₂ = 96.4%

Three Stages Conc. H₂ = 98.8%

For 85% H₂ One Stage Conc. H₂ = 94.4%

Two Stages Conc. H₂ = 98.1%

Three Stages Conc. H₂ = 99.4%

Metal Supported 70 Å Ceramic Membrane Achieves Knudsen Separation

1514-X-43a
Permeance vs Temp
Mar 2005

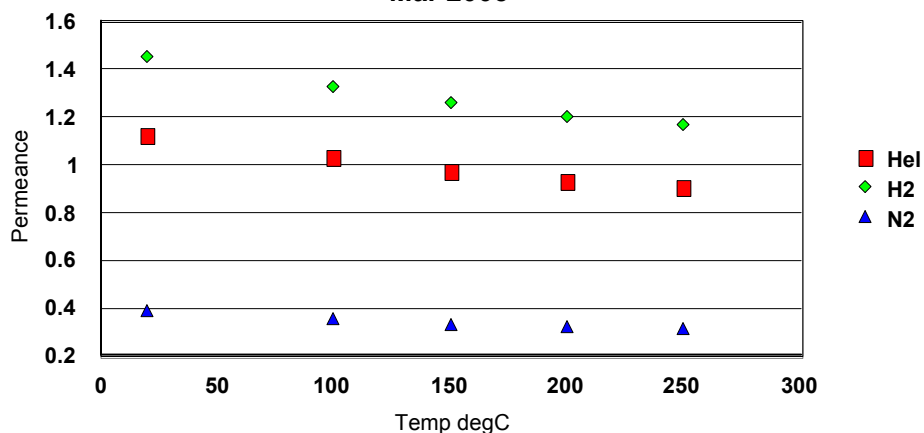

1514-X-43
Separation Factor
Mar 2005

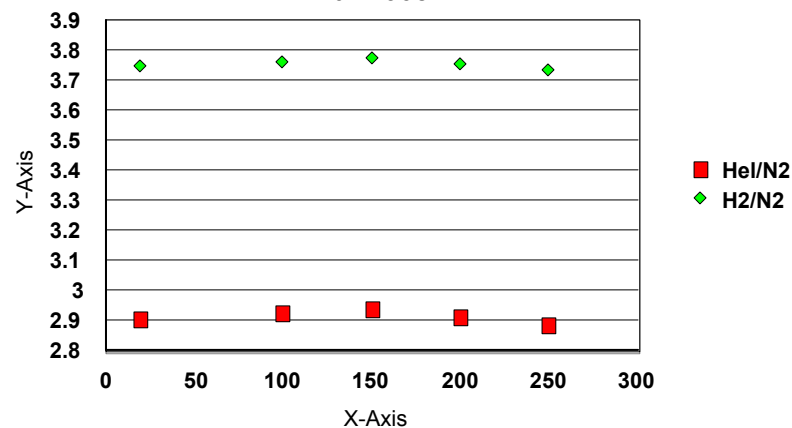

Theoretical Separation Factors

H₂/N₂ 3.74

He/N₂ 2.65

Early Mixed Gas Separation Results

Temperature °C	% Hydrogen in Feed	% Hydrogen in Permeate	Separation Factor
200	37.0	52.1	1.85
300	59.2	72.1	1.79
400	67.3	79.2	1.85

It is believed that lower than expected separation factors were obtained because:

1. of difficulty keeping all of the system components above the condensation temperature of the steam.
2. Inadequate mixing may have caused concentration polarization where the hydrogen is depleted at the membrane surface and CO₂ is increased due to higher hydrogen permeance.

New Test System Employs High Temperature Pressure Transducers and Metered Water Injection

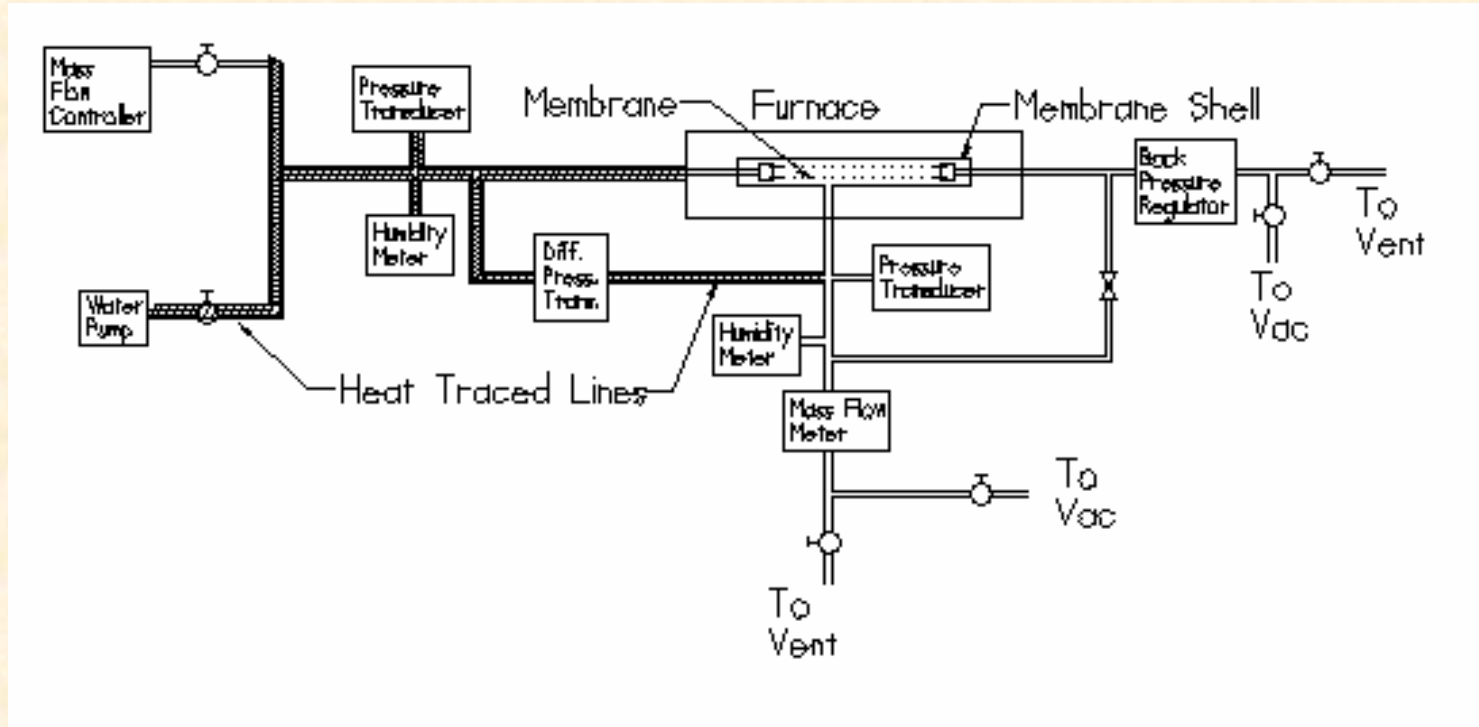

Modifications to system include:

1. Added second humidity sensor
2. Lowered operating pressure to reduce condensation problems
3. Meter water in as liquid

HTE Status

- Knudsen diffusion will yield a separation factor for hydrogen from steam of 3
- Knudsen membranes have very high fluxes.
- Knudsen membranes should be less expensive to manufacture and more thermally stable than microporous membranes used for SI process.
- Required purity can be achieved in 2 stages.
- A metal supported ceramic membrane was evaluated for the selectivity of helium from nitrogen and was found to achieve Knudsen selectivities.
- Preliminary separation tests on mixed gases achieved selectivities less than one would expect based on Knudsen diffusion. Results were believed to be caused by condensation of steam at pressure gauges.
- New test system has been fabricated. New system addresses potential condensation problems by operating at pressures less likely to have condensation.

Plan for Remaining FY07

- **Complete shakedown of test system.**
- **Test membrane up to 800 °C**
- **Test membrane for long term operation of approximately 1000 hours**
- **Prepare membrane test module for testing at Idaho National Laboratory**