

2007 DOE Hydrogen Program Review

Test of High Temperature Electrolysis ILS Half Module

J.J. Hartvigsen, S. Elangovan, A. Nickens
Ceramatec, Inc., Salt Lake City, UT

May 15, 2007

C.M. Stoots, J.E. O'Brien, J.S. Herring
Idaho National Laboratory, Idaho Falls, ID

Project ID # PDP 26

Overview

Timeline

- Half-ILS Module
 - Test start date: 6/28/2006
 - Test end date: 9/22/2006
 - Time on stream: 2055 hours
 - Production rate: 1.25 Nm³/hr

Budget

- Total project funding
 - DOE NHI Program
 - Ceramatec sub to INL
- Ceramatec FY06 Funding
 - ~ \$450k
- Ceramatec FY07 Funding
 - TBD

Barriers

- H₂ generation by water electrolysis
 - G – Capital Cost
 - H – System Efficiency
 - I – Grid Electricity Emissions
 - J – Renewable Integration

Partners

- INL: Lead Laboratory
- Ceramatec: Fabrication/Testing
- ANL: Post Test Examination

Objectives

- 2006 Preparations For INL CY07 Test
 - Integrated Laboratory Scale (ILS) Hydrogen Production
- Test “Half-ILS Module” at Ceramatec
 - 2x60 cell stacks in similar configuration to full module
 - Show performance scales with stack height
 - Assess system issues with tall stacks
 - Exercise component production capacity
 - 100 cells/month
 - Deliver first full ILS module to INL

Approach

- SOEC Leveraged By SOFC Background
- Influenced by Ceramatec 20 years of SOFC R&D
 - Cell & stack foundation R&D: EPRI, GRI, DOE
 - System view developed from larger demo projects
 - NorCell 1993, 1.5kW system on natural gas
 - DARPA 1996, 1.2kW system on JP-8
 - DOE Advanced Manufacturing ... (AMPS)
 - DOE SECA team
 - Back to foundation R&D, SECA CTP, SBIR, etc.
- Ceramatec now has only ~ 4 years in SOEC R&D
 - INL, SBIR, DOE EERE H₂ Production

SOFC-SOEC

Contrasts in (Potential:Composition) Space

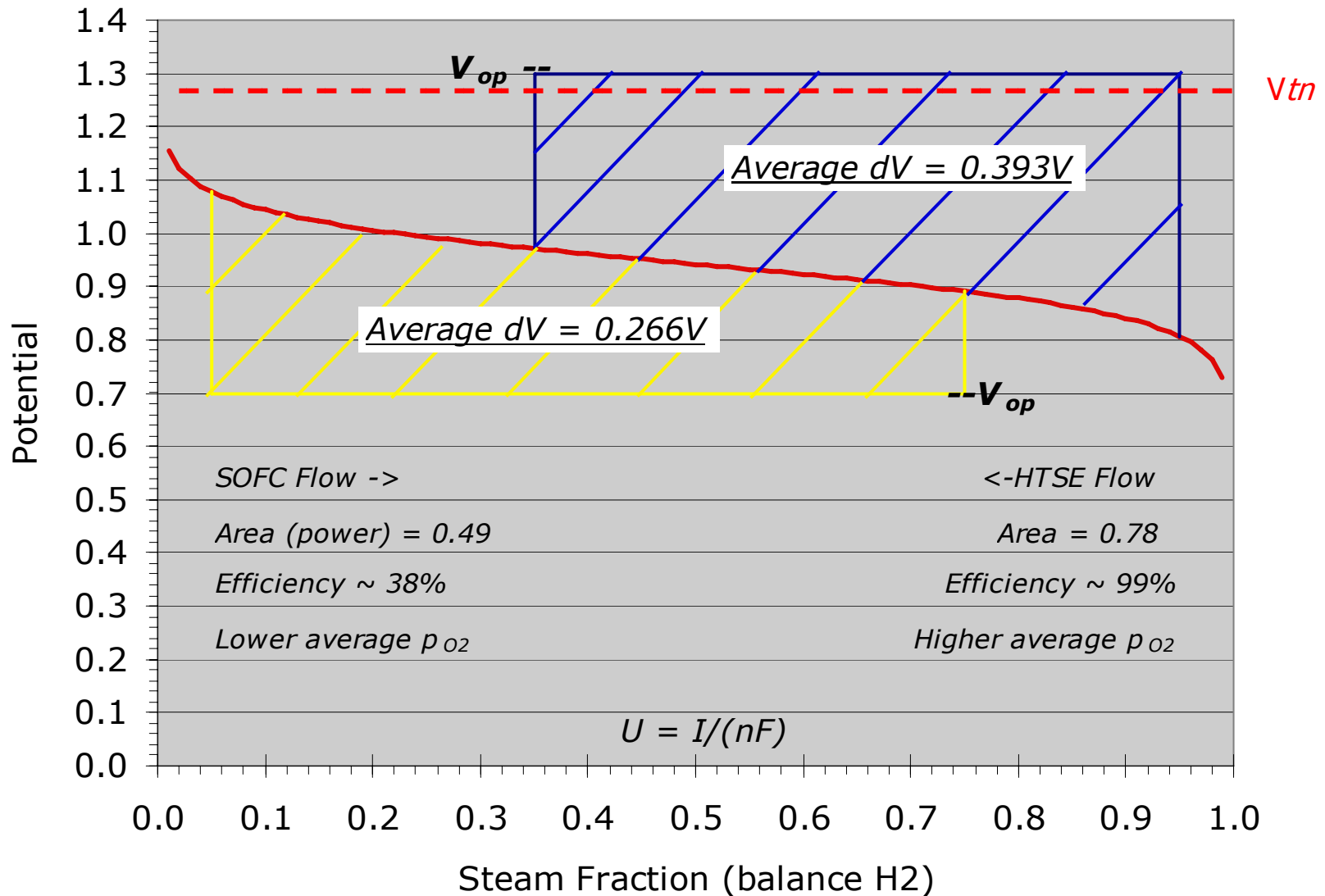

Implications Drawn From Thermodynamics

- SOEC relative to SOFC has
 - Higher average p_{O_2}
 - More severe corrosion conditions from steam & O_2
 - Less potential for undesirable mixed conductivity, e.g.
 - Ceria electrolyte
 - Perovskite ions
 - Higher performance (current, power, efficiency)
 - More uniform stack temperature
 - Potential system heat deficiency

SOFC vs. SOEC Design Differences

- Cells are virtually identical
 - Same electrolyte, electrodes, pattern, etc.
 - Oxygen evolution creates asymmetry in oxygen electrode supported SOEC
 - Opposite effect exhibited in hydrogen electrode supported SOFC
- SOEC seals more challenging
 - Higher back pressure on seals due to product collection vs. burner
 - Low molecular weight stream vs. reformat
 - Diffusion mechanism more active relative to hydrodynamic
 - Hydrogen permeation in metal icon destabilizes air side scale
- SOEC is more corrosive environment
 - High steam content
 - High oxygen concentration
 - Coating changes and seal compatibility study (glass fluxes scale)
- Potential icon design differences due to
 - Design air channels for heat rejection or injection (channel size)
 - SOEC has potential for very large cell areas

SOFC-SOEC System Differences

- SOFC spent fuel burner
- SOFC heat rejection to enclosure
- Steam generator vs. reformer heat loads
 - SOFC reformer is a chemical recuperator
 - SOEC stack is a chemical recuperator
- Air flow & preheat requirements
 - SOFC 6-12 air stoichs relative to current
 - SOEC 0-2 air stoichs relative to current

SOFC-SOEC Operational Differences

- Power source/sink
 - Power supply simpler than SOFC power cond.
 - Fast voltage slew rate, little risk of thermal shock
- Potential difference in migration/transport
 - Cr poisoning?
 - Oxygen concentration gradients and flux reversal
 - Other electrode electro-migration issues
 - SiO₂ transport reported by Risø
- Additional undiscovered issues?

Addressing Tall Stack Failure Probabilities

U.S. Patent

Apr. 9, 2002

Sheet 1 of 3

US 6,368,739 B1

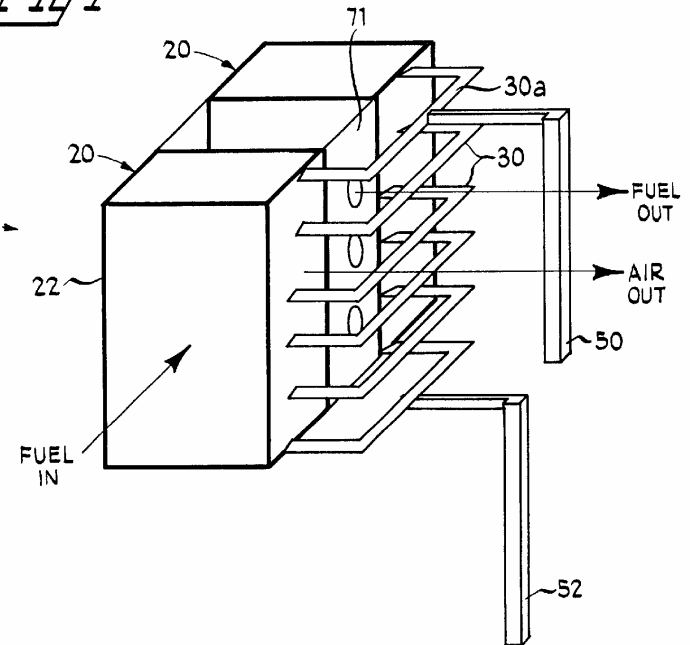
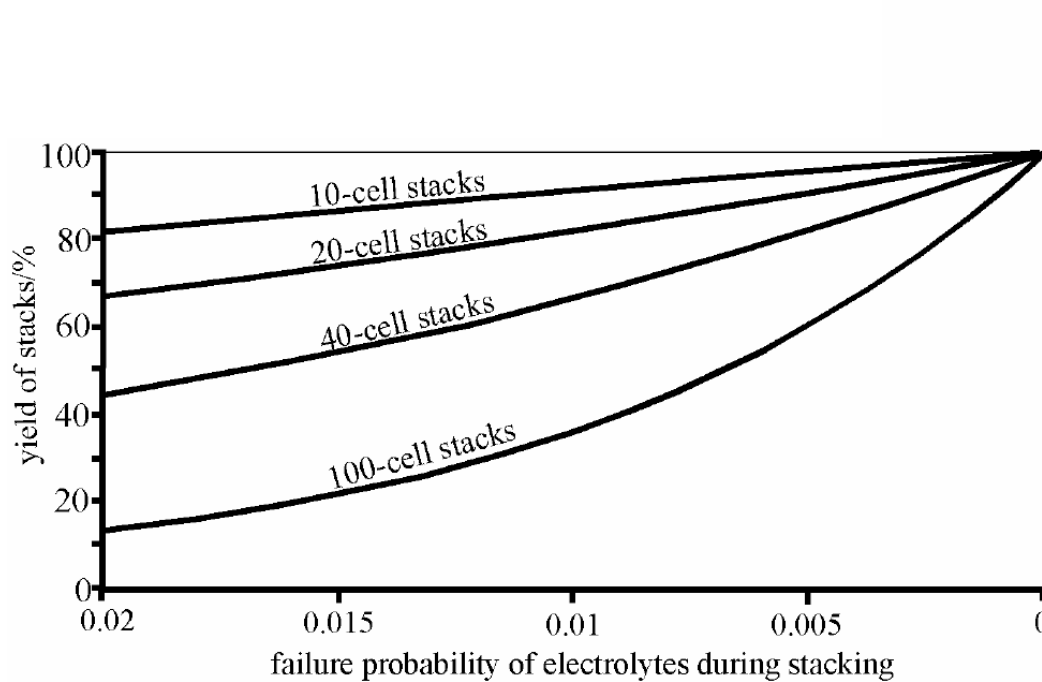

*From Detlef Stolten
High Temperature Electrolysis IEA Meeting
05 November 2004, San Antonio, TX*

*Ceramatec approach to mitigate
risk in tall stacks*

SOFC Test Stand Used In Half-ILS Test

- Test stand features
 - SOFC thermally self sustaining (TSS) unit
 - Air recuperator
 - Reformer/Steam Generator
 - Process instrumentation and controls
 - Space to accommodate desired stack pair
 - Electric heater w/trim natural gas burners
 - Custom LabView Data System

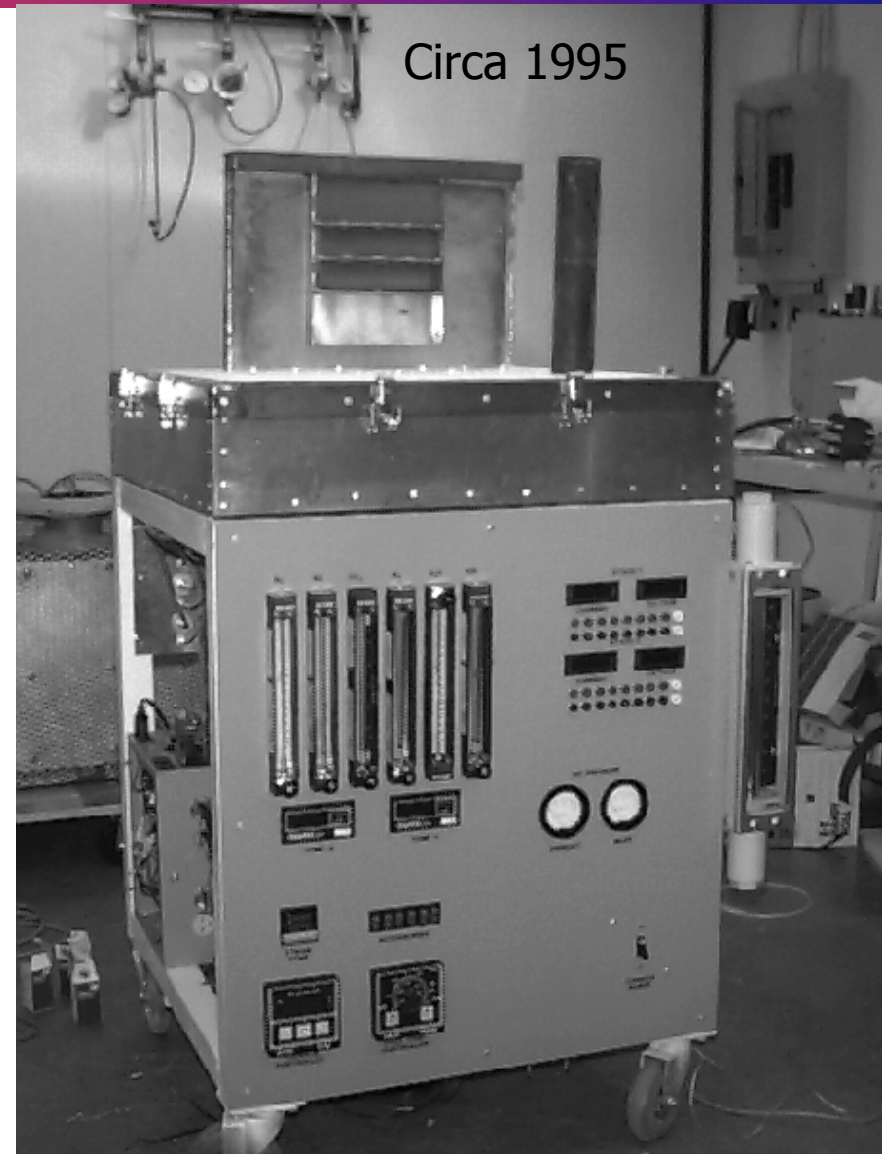

Facility Safety Features

- Outside bulk storage of H₂ & N₂
 - Pressure relief vents outside with regulator failure
 - Reduced cylinder handling
 - Outside emergency shutoff
 - Solenoid valve shutoff by hydrogen sensor or power failure
- Flow restriction orifice for each test station
- Fusible link, release to close flammable gas valves
- Air flow sensing ΔP switch hardwired to DC supply
- Alarm auto-dialer triggered by data range windows in data acquisition software

Half ILS Module 60 Cell Stack Pair

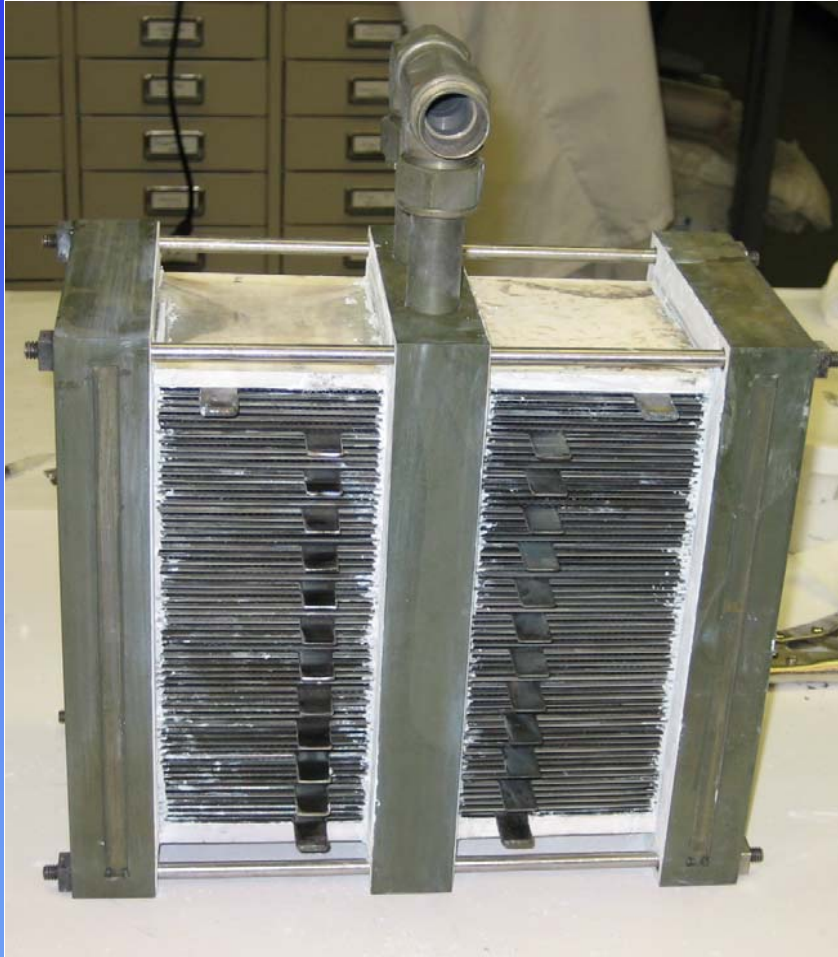

Installed Half-ILS 2x60 Cell Stack Module

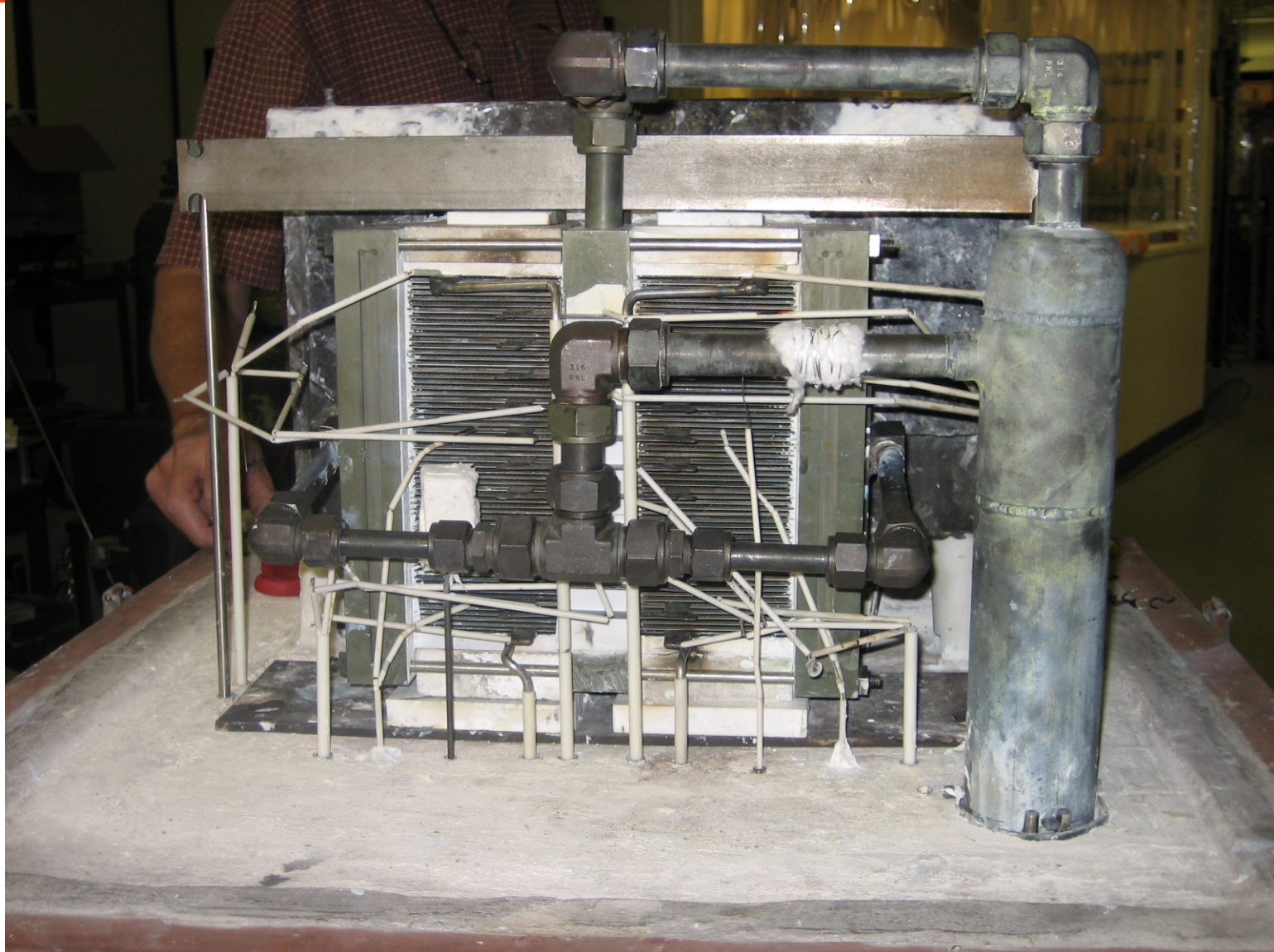

Technical Progress & Results



Half-ILS Steam Electrolysis Module in Operation

Initial Load Steps of Half ILS Module

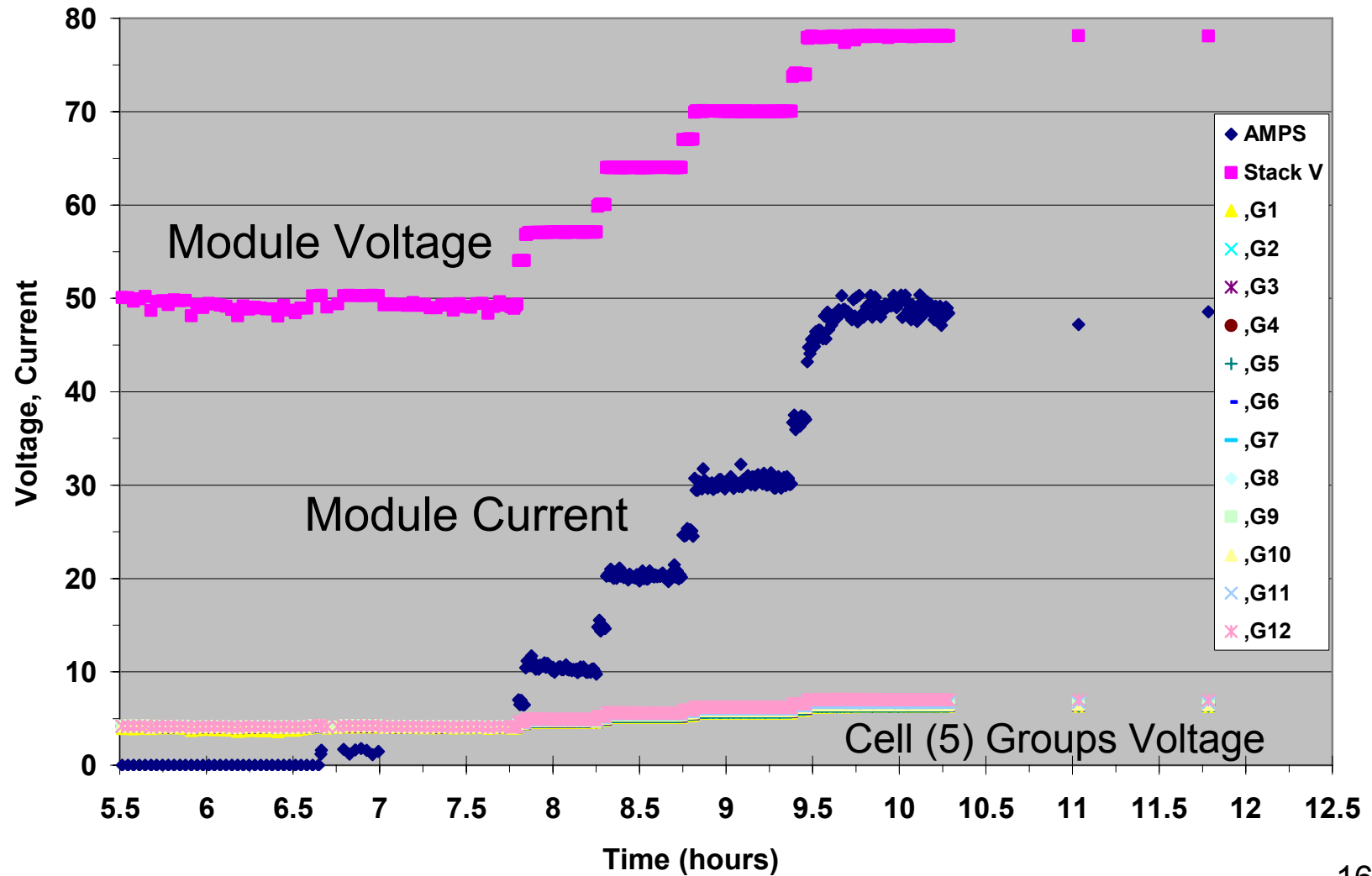

Outlet Dewpoint Response To Initial Loading

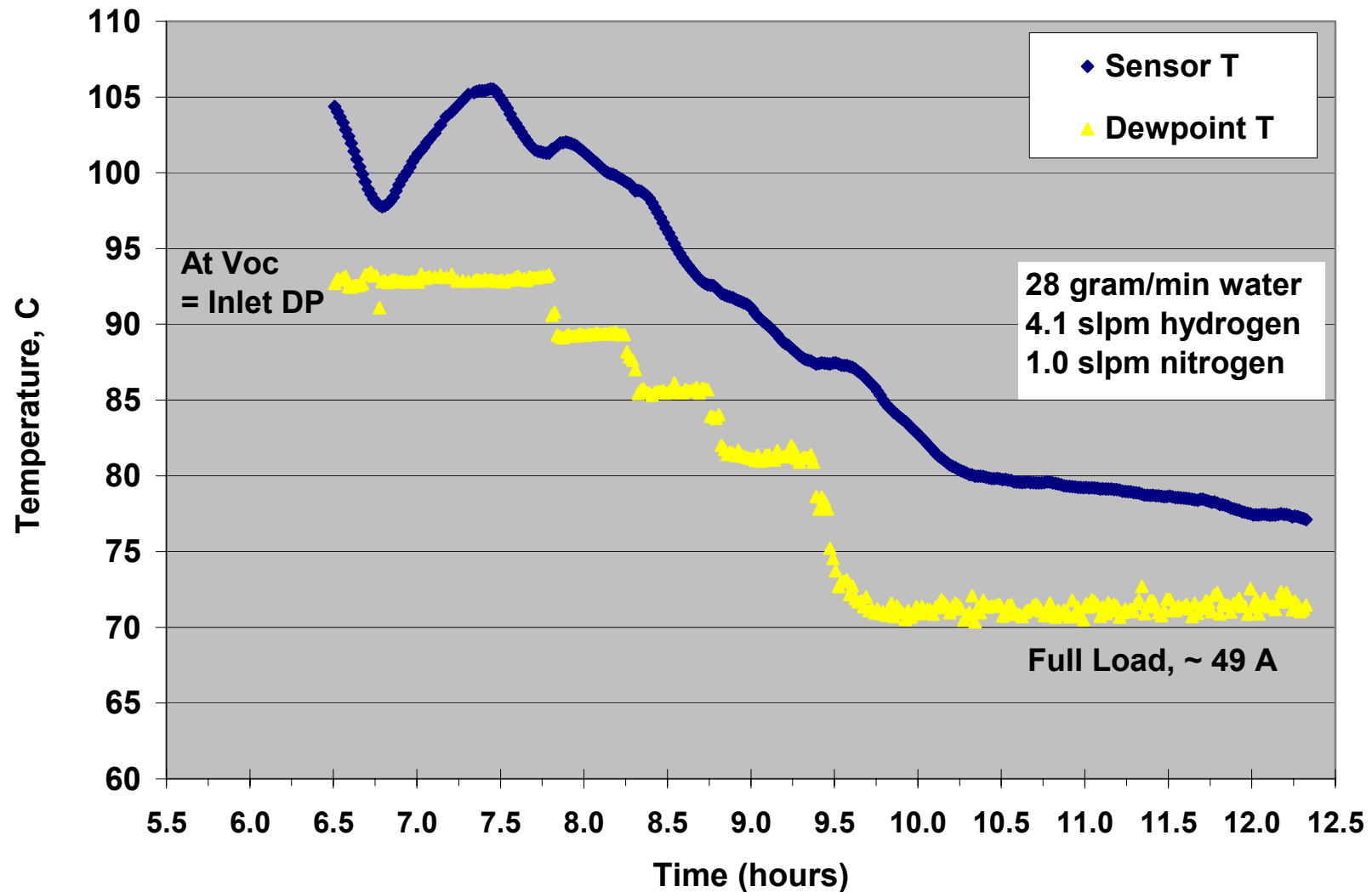

Temperature Response To Initial Load Steps

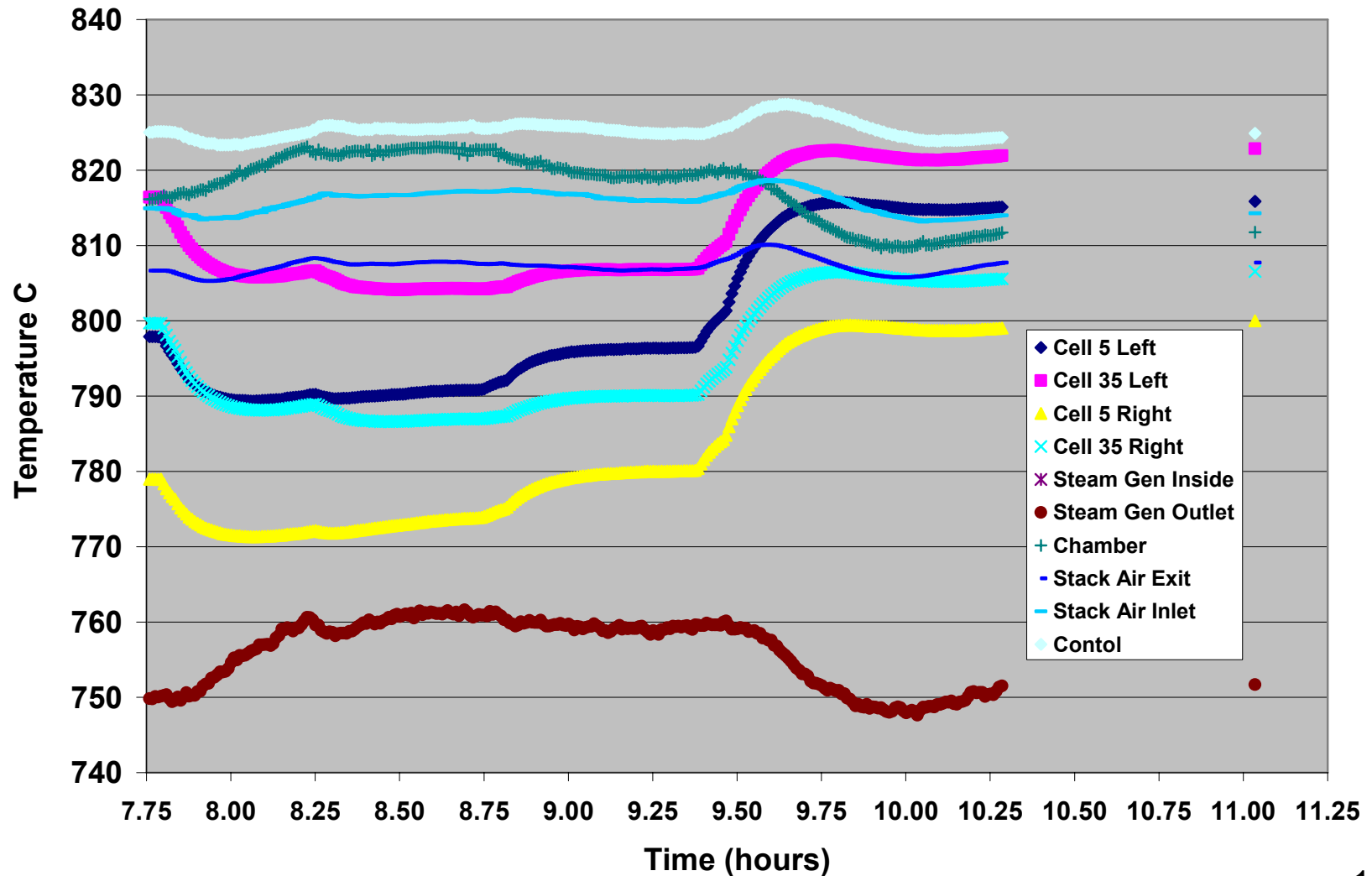

Predictions Reconciled to Average Initial 18 Hour Data

HTE GAS FLOW WORKSHEET Half ILS Module Qual Stacks

June 29, 2006

2	Stacks		
60	Cells/Stack	9.65E+04	Faraday's Constant
120	Total Cells	82.06	R, cm ³ -atm/g-mol K
64	cm ² active	815	T, C
20.0%	Nitrogen% of H2+N2	1088.15	T, K
92.0	Inlet Dewpoint	197.5	Tstd, K
58.3%	Steam Utilization		
2.4	Sweep Air Stoichs		
1.045	ASR ž-cm2		
1.301	Vop V/cell		

YSZ thickness	0.02
rhoel ohm-cm	22.28
k S/cm	0.045
YSZ ohm-cm ²	0.446
OP ohm-cm ²	0.614
cell ohm-cm ²	1.060

78.06	Stack Vop	48.63	total current
0.872	Inlet Steam fraction		
0.364	Outlet Steam fraction		
0.833	V/cell E _n (U)		Reversible potential at steam inlet
49.98	Stack Voc		
0.958	V/cell E _n (U)		Reversible potential of hydrogen product
0.904	V		E _{nbar}
-0.380	A/cm ² j _i	1.23	Apparent ASR
-0.652	A/cm ² j _f		100% steam utilization current density
-24.31	Amps/stack		Stack Current
-41.71	Amps		100% steam utilization current
-3795.8	Watts		Total Power

	Air Flow Rate	H2O Feed Rate	H2 Feed Rate	N2 Rate	H2 Exit Rate	H2O Exit Rate	H2 Production
g-mol/sec	8.64E-02	2.59E-02	3.05E-03	7.63E-04	1.82E-02	1.08E-02	1.512E-02
g/sec	2.51E+00	4.67E-01	6.15E-03	2.14E-02	3.66E-02	1.95E-01	3.05E-02
normal liters/min	116.2	28.0	4.1	1.0	24.437	11.69	20.335
	liquid cm ³ /min ^{^^^}				liquid cm ³ /min ^{^^^}		

Air Rotameter 16%

	Inlet	Outlet	Dry	GC
N2	0.026	0.026	0.040	3.46
H2	0.103	0.611	0.960	96.55
H2O	0.872	0.364		100.01
	1.000	1.000		

1220.1	nlph H2 production
2.633	kg/day
3.659	RT kW H2
96.4%	Efficiency

ChemCad Preheat Duty Worksheet

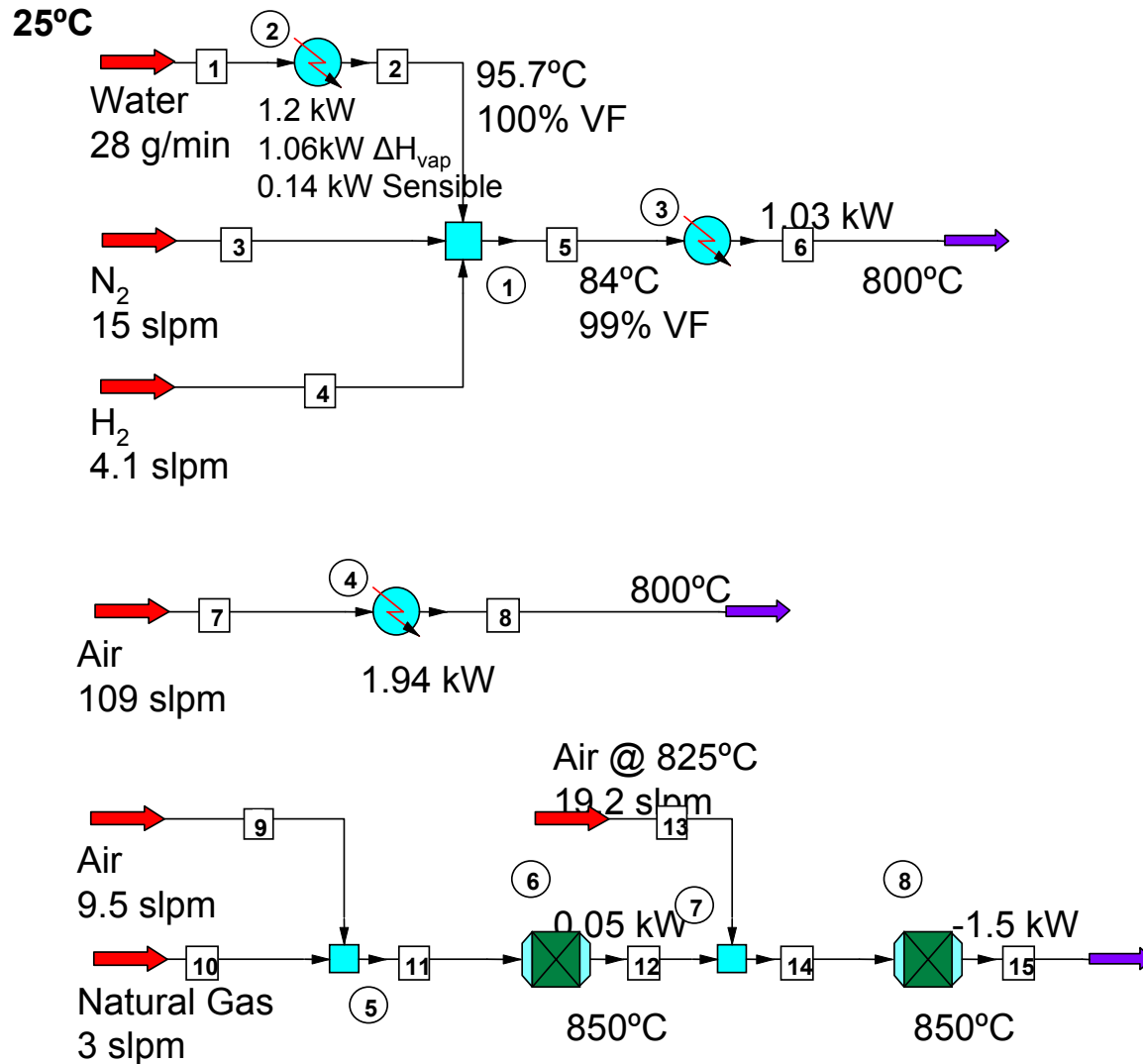

Reverse Shift & Electrolysis Of CO₂

Feed: H₂O, CO₂, (minor H₂, CO)

Reverse Shift Reaction: $\text{CO}_2 + \uparrow \text{H}_2 \rightleftharpoons \text{CO} + \downarrow \text{H}_2\text{O}$

As steam is consumed and H₂ produced the RSR proceeds to the right

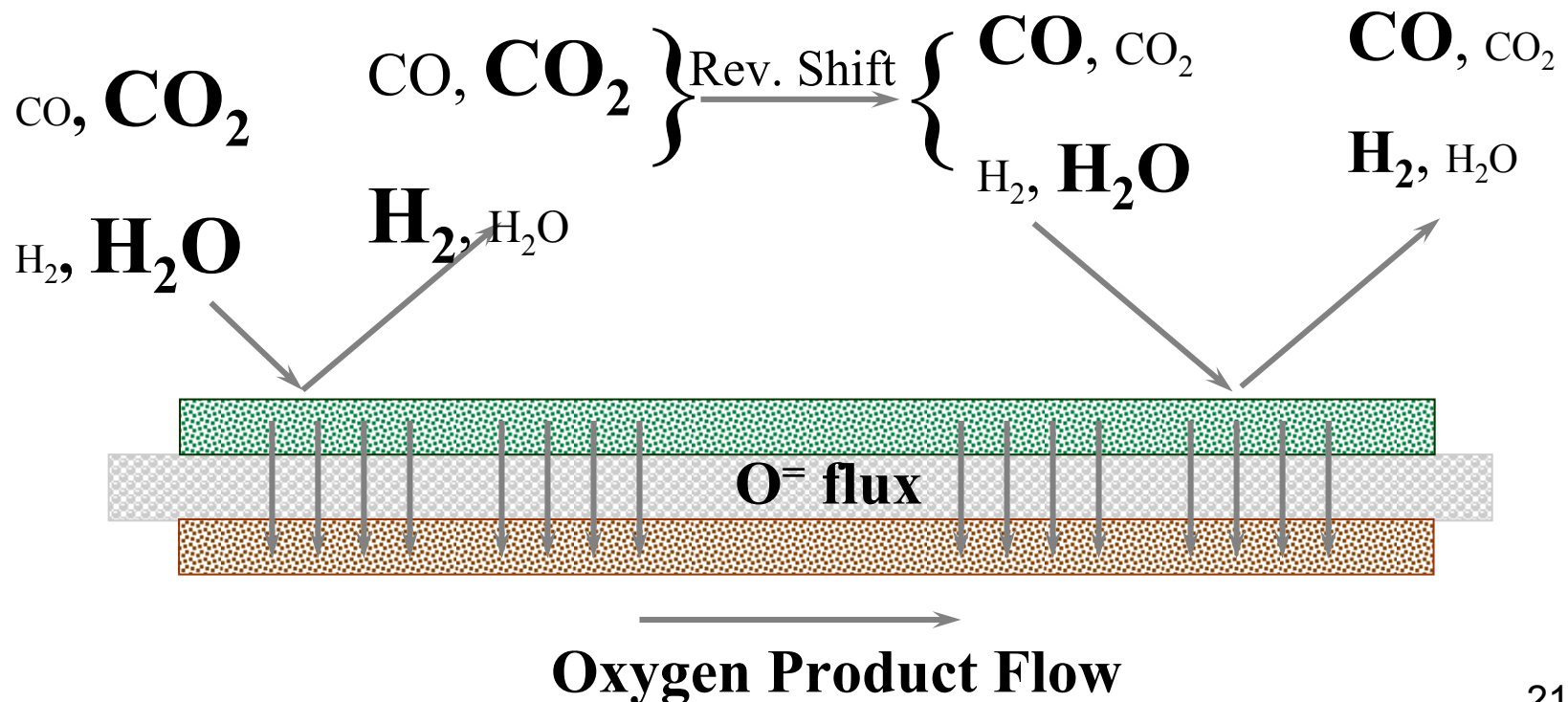

CO₂ Co-Electrolysis Thermal Neutral Voltage Map

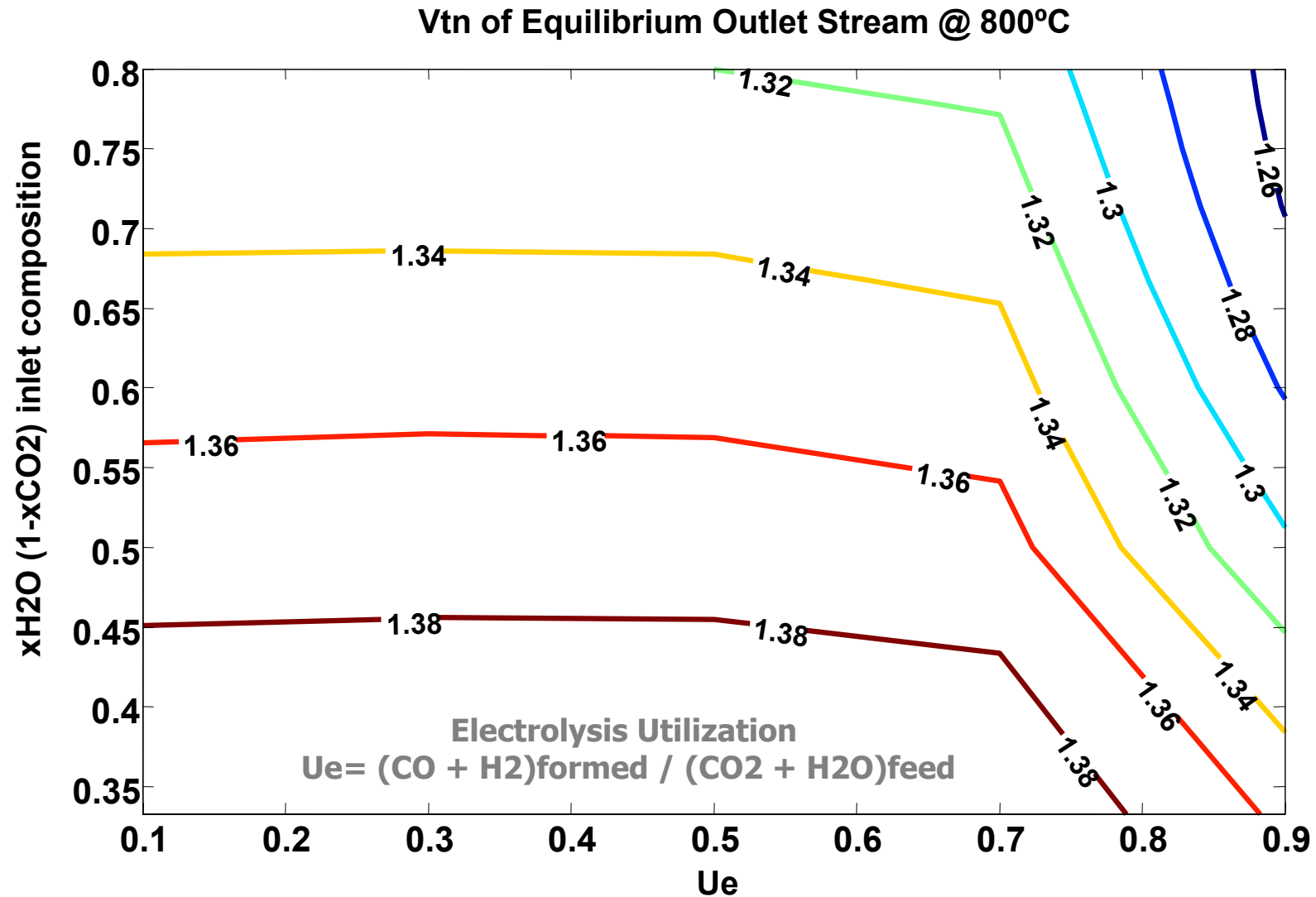

Half ILS Module Load History

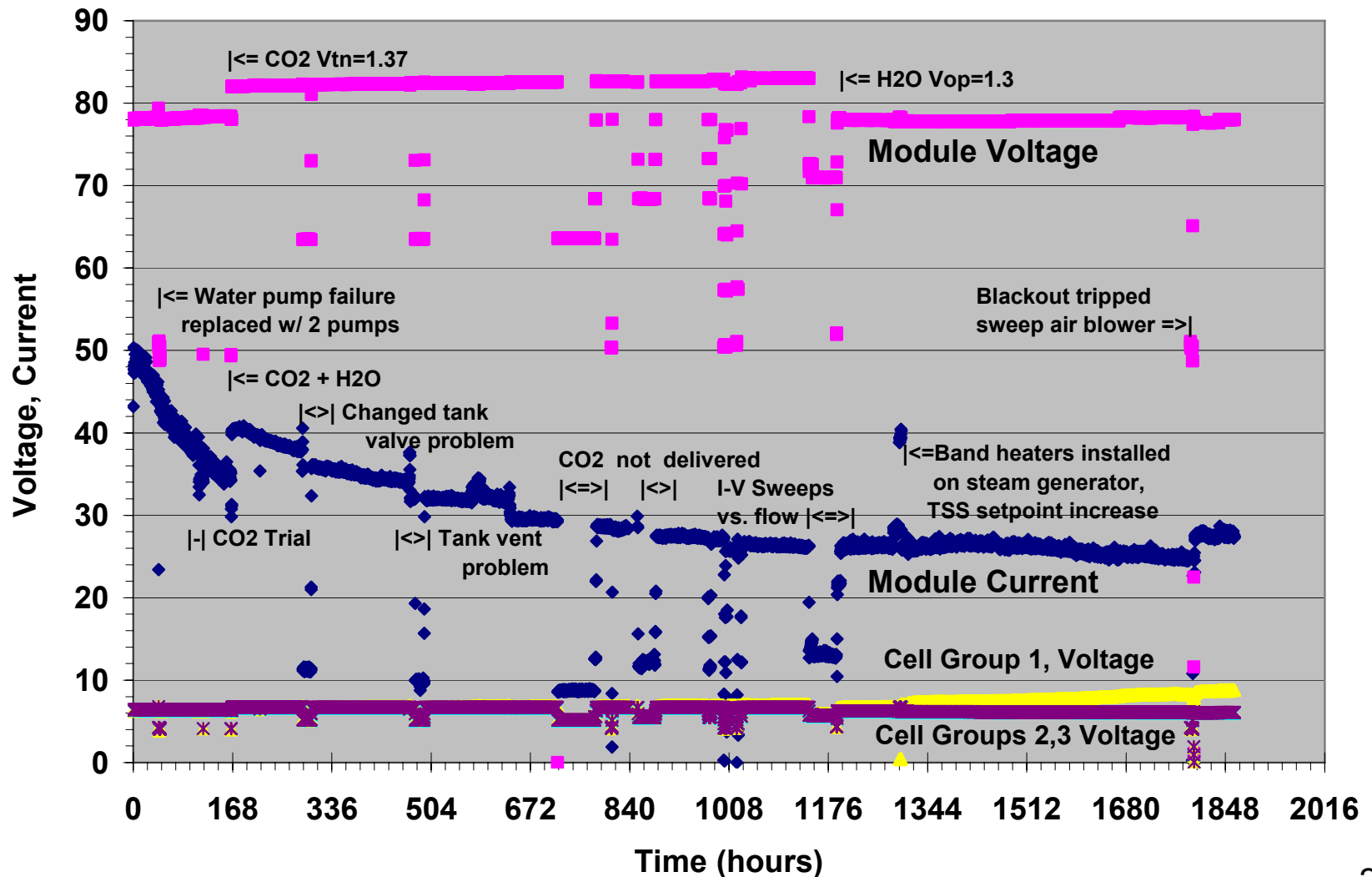

Half ILS Module Temperature History

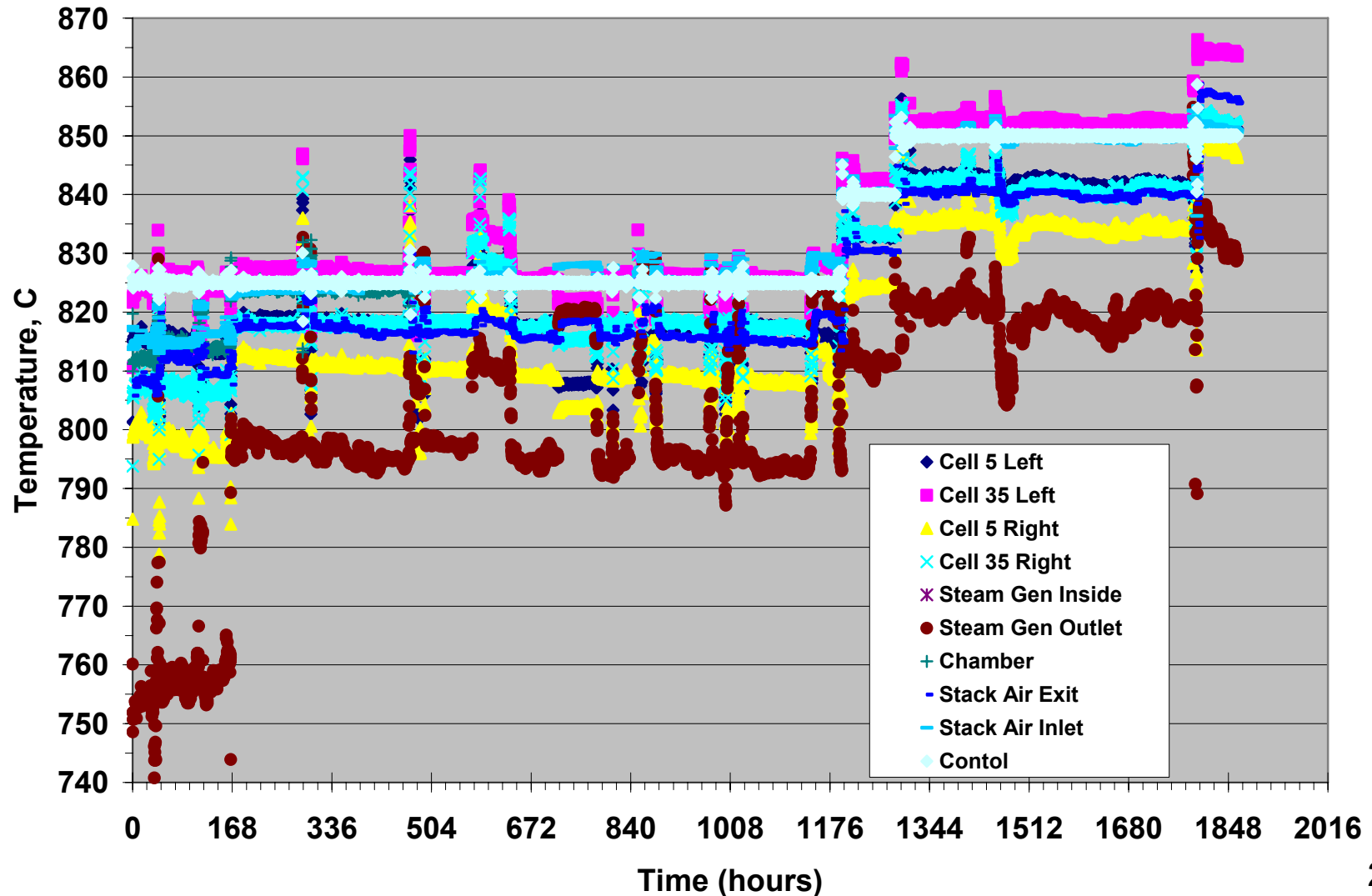

Operational Issues

- Water
 - Metering pump failures
 - DI line shutoff anticipated (check valve & bladder pressure tank)
 - Steam generator
 - Higher than anticipated duty
 - Band heater failures
- CO2
 - Delivery, tanks, etc.
- Intense thunderstorm blew rain in vents, shutoff DC power
- Blower Trip (variable speed control reset after blackout)
- Furnace heating, initially appeared underpowered heaters
- DAQ System lockup
- Equipment scavenged for new tests
- ...as the history charts show, reality isn't always pretty.

Half ILS Module Post Test

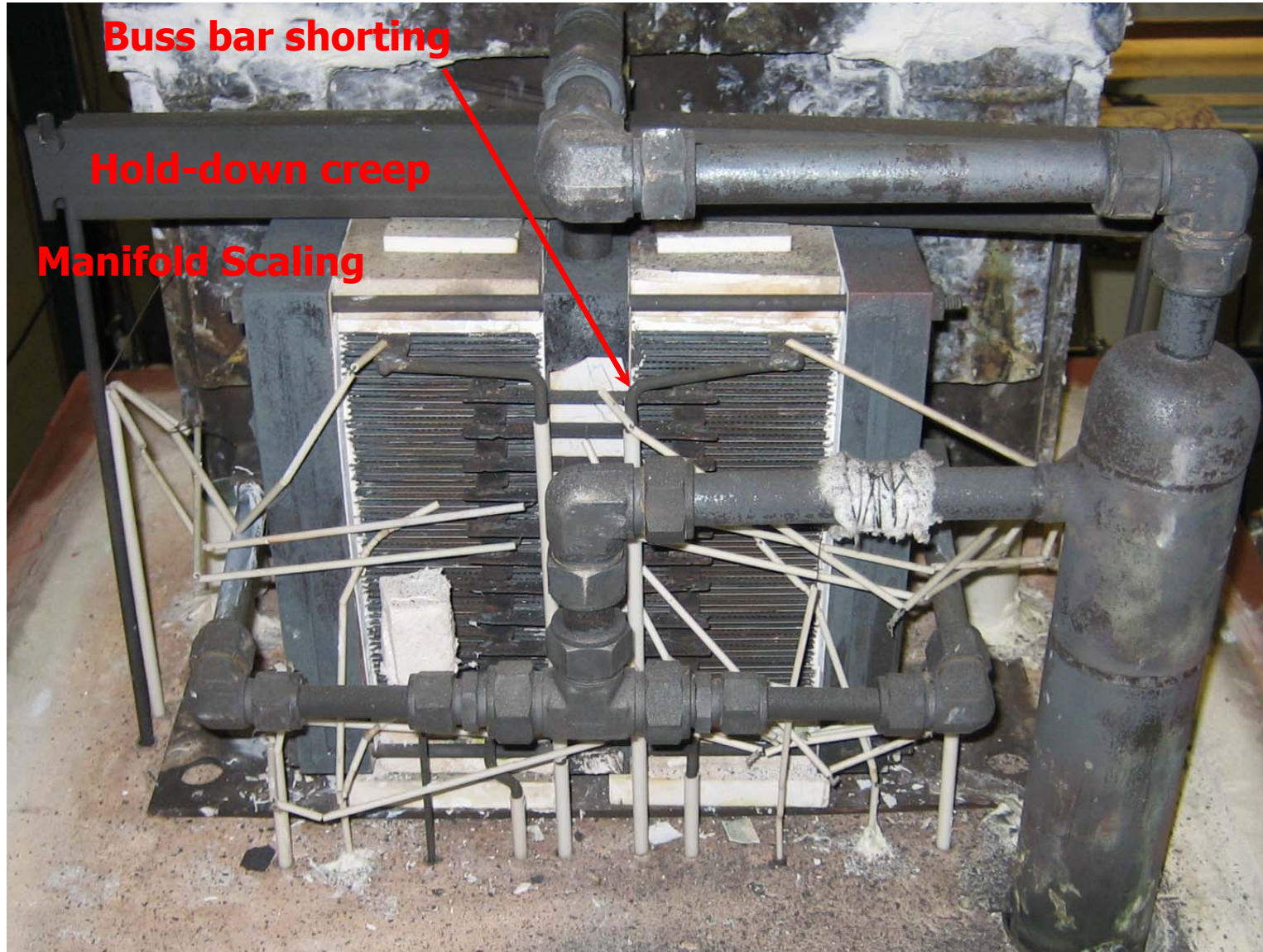

Manifold Scaling and Buss-bar Shorting



Half-ILS Manifold Corrosion

Top-Right-Outside Face of Center Frame



Manifold Corrosion Shorting of Cell Group #1



Cross Section of Repeat Unit From Half-ILS Stack

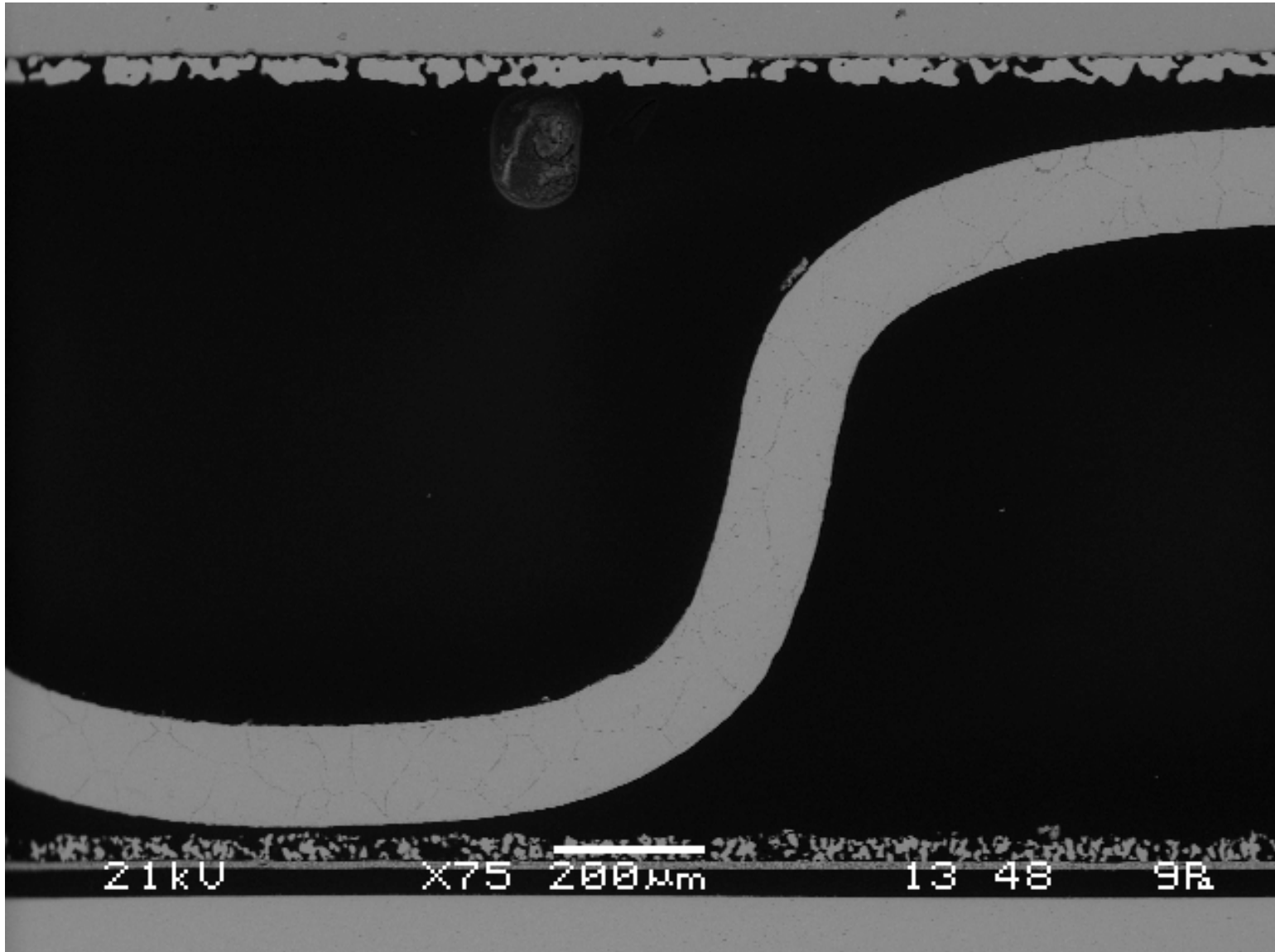

Cell and Interconnect SEM Examination

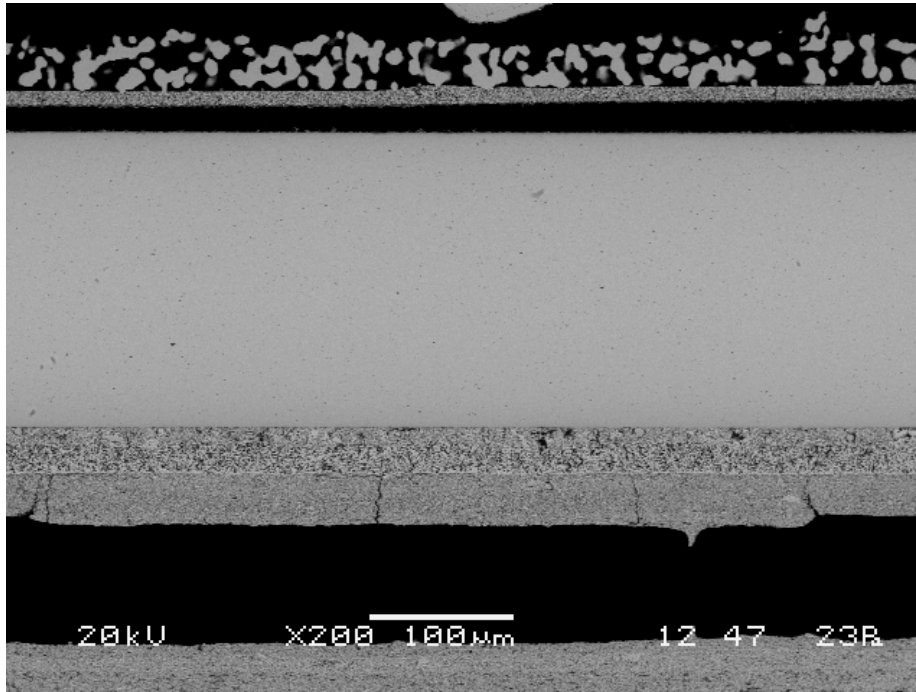

Hydrogen electrode

Electrolyte

Metal separator plate,
oxygen evolution side

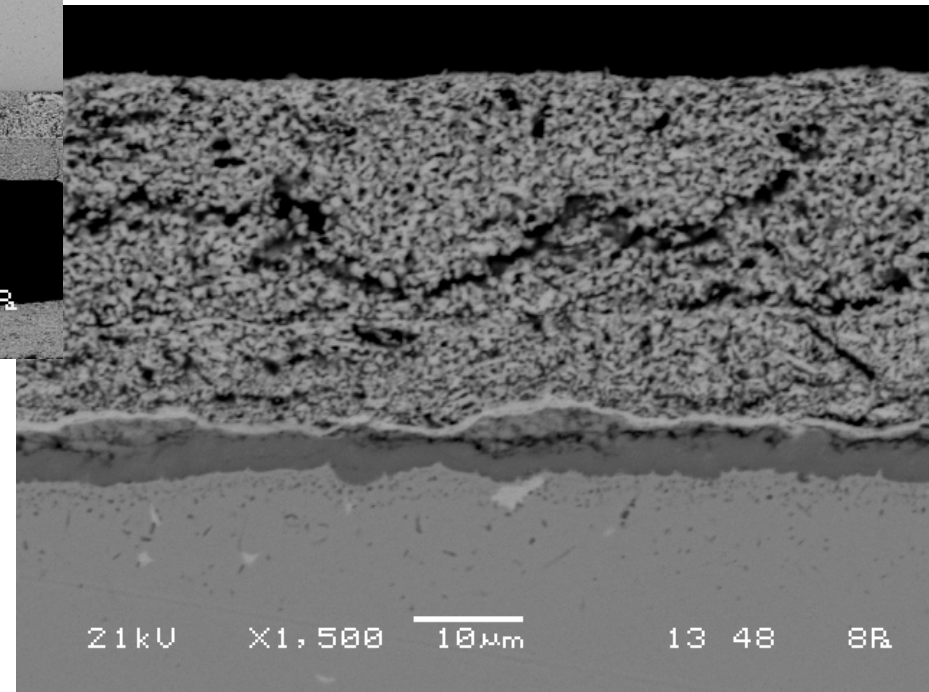

Improved Stacking Process (Post Half-ILS)

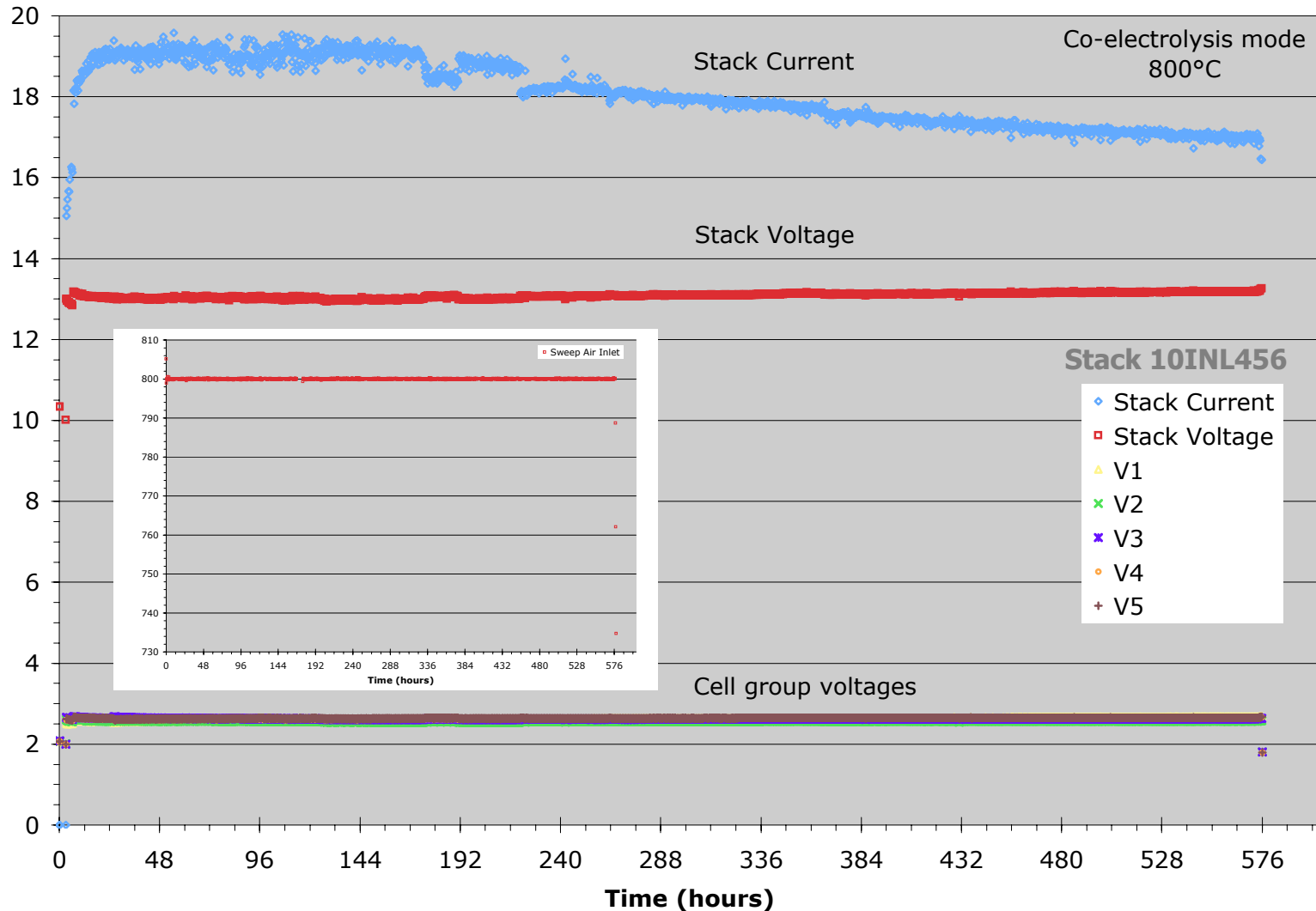

ILS Full-Module Delivered to INL

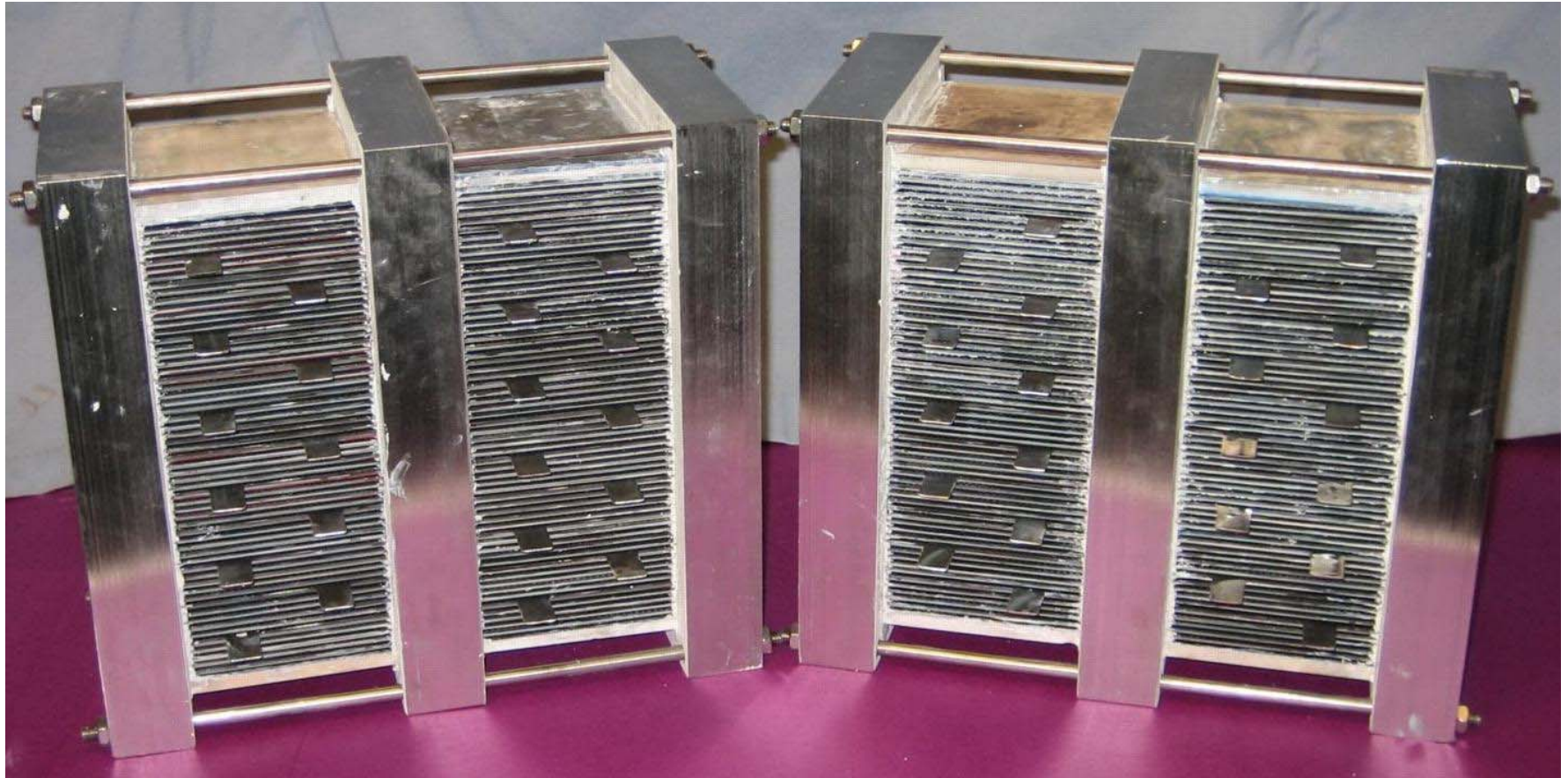

First 240 Cell Steam Electrolysis Stack Module Delivery

Future Plans

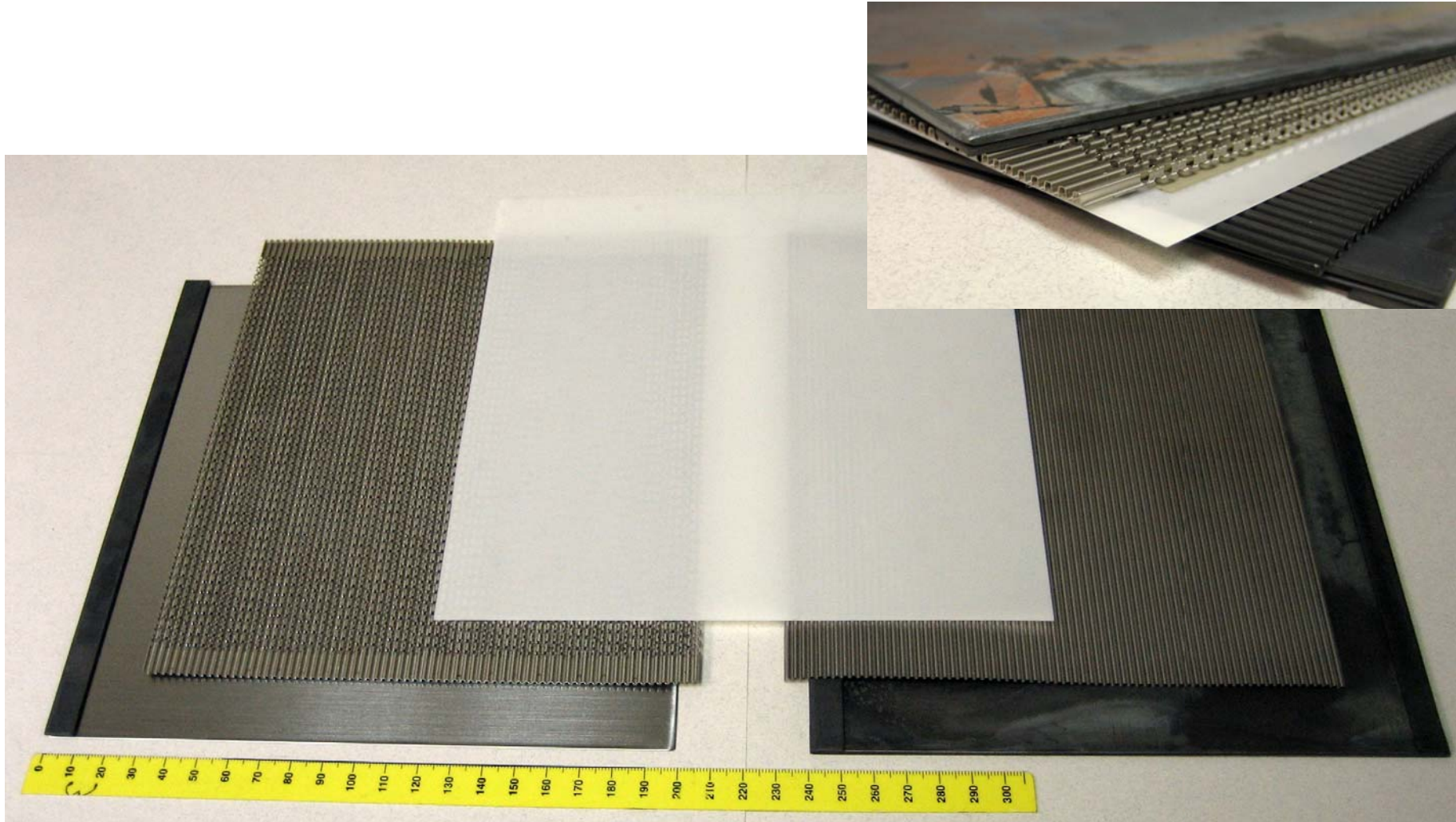

20cm Electrolysis Stack Components

20cm Stack Component Production

- Flowfields complete
 - 1.5mm height vs. 1.0mm for 10cm parts
- Edge rails & separator plate coatings
 - Testing Crofer 22 APU alloy (available in needed form)
- Manifolds
 - Fabrication drawings done
 - Replacement for 440C alloy required custom hot rolling
- Cells
 - Sample electrolyte produced
 - Electrode printing screens order in Nov.
- Short stack test fixture/furnace insert

Summary

- Half ILS test at Ceramatec successful in
 - Narrowing gap from cell to stack
 - Showing tall stack ASR matching 10 cell stack
 - Proving co-electrolysis in stacks
 - Showing extended operation, but deg. high
 - Convincing that system factors are important
- Full module tests planned in CY07
 - Delivered full 4 stack module in March 2007
- 20x20cm parts in process for testing in CY07
- Need to develop industrial scale cells

Energy Policy Options Enabled by HT Electrolysis

- Produce
 - Hydrogen for heavy crude, tar sands and oil shale upgrading
 - FT liquids & methane motor fuel for liquid fuel and CNG vehicles
 - Energy density and delivery compatible with current equipment
 - Byproduct oxygen for coal/biomass gasifiers
 - Be ready for Hydrogen Economy when distribution and storage issues solved
- Synfuel production (FT liquids & Methane) exothermic
 - Integrate CPV, wind, and nuclear power
 - Both secondary processes exothermic (process integration)
 - Integrate process heat from synfuel (FT or methanation) exotherm
- Switch between hydrogen or syngas production as needed.
- Leverage DOE Fossil Energy developed SOFC technology
- Utilize some CO₂ captured from baseload coal plants to capture energy in intermittent RE sources

High Temperature Electrolysis Research Needs

- More testing
 - “Milestone Event” vs. routine development test modes
 - Exercise production capacity
- More test stations
 - Evaluate materials and process improvements
 - Statistical performance distributions
 - Extended lifetime testing
- Cell area scale up
- Stack size scale up
- System BOP development