

Purdue Hydrogen Systems Laboratory

A. Brockman, S. Basu, P. Gagare, M. Diwan
E. Shafirovich, Y. Zheng,
P. V. Ramachandran, A. Varma, J. Peterson, J. Gore
Purdue University, West Lafayette, IN
R. Kramer, L. Pelter, E. Ting
Purdue University, Calumet, IN
P. Maness
National Renewable Energy Laboratory

June 9, 2008

This presentation does not contain any proprietary, confidential, or otherwise restricted information

Overview (storage)

Timeline

- Start–September 2006
- End–September 2009
- 50% complete

Budget

- \$1,747,500
 - \$1,398,000 (DOE)
 - \$349,500 (Purdue)
- Funding received in FY07 non-cost extension
- Funding for FY08 \$ 738,000

Barriers

- Barriers addressed
 - A. System weight and volume
 - J. Thermal management
 - R. Regeneration process
- Targets

		2007	2010	2015
Gravimetric capacity	kgH₂/kg (wt%)	0.045 (4.5%)	0.06 (6%)	0.09 (9%)
Volumetric capacity	kgH₂/L	0.036	0.045	0.081

Partners

- General Motors (lab infrastructure)
- General Atomics (AB synthesis)

Overview (production)

Timeline

- Start – September 2006
- End – September 2009
- 50% complete

Budget

- \$720,000
 - \$576,000 (DOE)
 - \$144,000 (Purdue)
- Funding received in FY07
non-cost extension
- Funding for FY08
\$ 246,000

Barriers

- Barriers addressed
 - Al. H₂ molar yield
 - AK. Feedstock cost
 - AL. Systems engineering
- Targets

	2007	2010	2015
Hydrogen yield percentage (%)	20	25	> 35

Partners

- Cargill
- Griffith Labs
- Advanced Power Technologies
- Innovene
- NREL
- BP

Objectives

- To improve the extent, rate and control of hydrogen release from ammonia borane (AB) by hydrolysis reactions
- To discover practical uppermost hydrogen storage density of the AB hydrolysis approach
- To understand engineering properties of the AB hydrolysis approach
- To characterize the dehydrogenation products and develop new methods for AB regeneration
- To investigate reaction mechanism and effect of process parameters on yield of hydrogen generation by **novel** noncatalytic AB hydrothermolysis.
- To determine parameters that maximize anaerobic biological hydrogen production
- To understand energy balance for a local modular energy system using biological/solar technology

Milestones

Month/Year	Milestone or Go/No-Go Decision
Dec-07	Milestone: complete investigation of major engineering properties of AB hydrolysis. This provides information on the design, modeling and testing of a subscale AB slurry hydrolysis apparatus.
Jan-09	Milestone: improve the overall yield of the current AB recycling to greater than 80%, thus making it energy efficient.
Dec-07 Nov-08	Milestone: complete preliminary hydrothermolysis experiments with AB-lean aqueous solutions. The results are very promising and a provisional patent application for this invention was filed Milestone: complete investigation of kinetics, mechanism and yield of hydrogen generation from AB solution/slurry hydrothermolysis. From this study, determine optimum process parameters to maximize H ₂ yield.
Mar-08	Milestone: complete development and initial testing of automated testing device to determine optimal conditions for anaerobic hydrogen production. This device accelerates the determination of optimal hydrogen production conditions.

Approach

- **Studied AB hydrolysis up to ~45 wt% of AB in ~55 wt% water**
 - Validated AB hydrolysis kinetics in solutions and slurries
 - Quantified ammonia generation
 - Measured aqueous solution densities and pH values
 - Measured byproduct solubility
 - Measured long term storage stability of AB solutions
 - Conducted engineering analysis of the AB hydrolysis approach
- **Developed methods for AB hydrogen-release and regeneration**
 - Screening transition metal catalyst for the hydrolysis of ammonia borane
 - Characterization and regeneration reactivity of BN products

Approach (cont'd)

- **Investigated noncatalytic AB hydrothermolysis**
 - Conducted isotopic experiments to understand reaction mechanism of hydrogen release from aqueous AB solutions/slurries.
 - Studied H₂ release kinetics and yield over a range of temperature, pressure and residence time conditions.
 - Developed and tested pressurized flow reactor for hydrogen generation system performance using PEM fuel cell.
- **Studied parameters that maximized hydrogen production from anaerobic fermentation of waste and energy value**
 - Collected candidate biological organisms and substrate
 - Conducted initial hydrogen production tests
 - Developed automated testing device for screening organisms, substrates, and operating conditions using statistical experimental design
 - Designed pre and post thermal processing system using vacuum tube solar collector
 - Reoptimized system energy balance with initial test results

Technical Accomplishments

AB Hydrolysis Experimental Apparatus

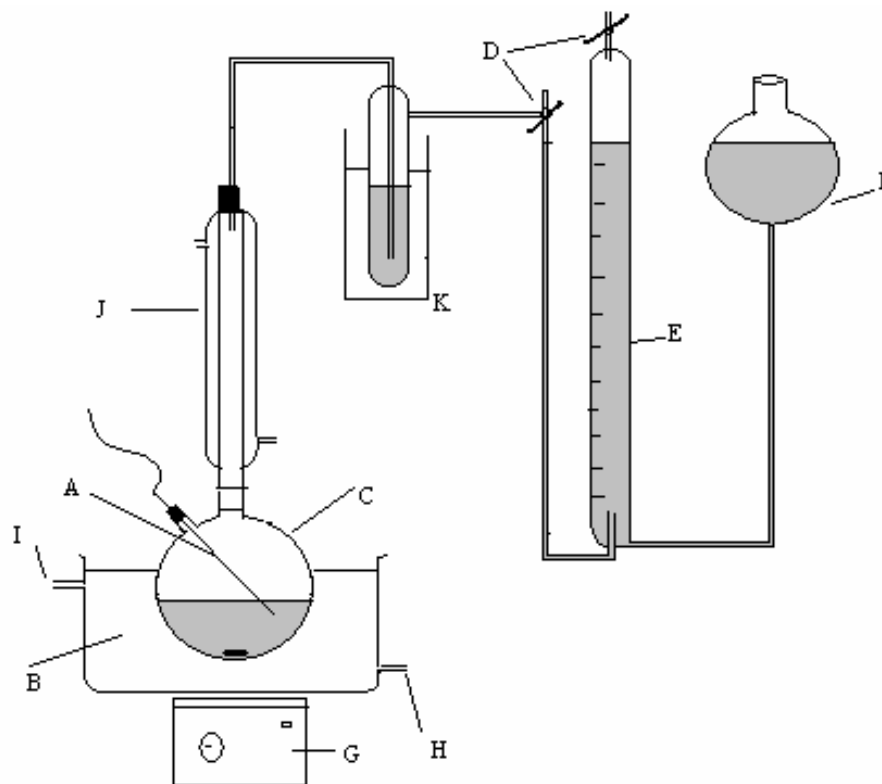

(A) thermocouple, (B) constant temperature water bath, (C) round-bottom flask, (D) stop cock, (E) gas burette, (F) leveling flask, (G) stirrer, (H) constant temp. water inlet, (I) water outlet, (J) reflux condenser, and (K) water trap.

Technical Accomplishments (cont'd)

AB Solution Hydrolysis and Ammonia Liberation

Entry	AB soln. wt. %	Catalyst		Addition time, min	NH ₃ liberated (%)
		MX _n	mol %		
1	25	RuCl ₃	0.06	45	7
2	20	RuCl ₃	0.06	45	6
3	15	RuCl ₃	0.06	45	4
4	15	RuCl ₃	0.06	15	4.4
5	15	RuCl ₃	0.2	45	3
6	15	RuCl ₃	0.2	15	7
7	10	RuCl ₃	0.06	45	1
8	6	RuCl ₃	0.06	15	<1
9	6	RuCl ₃	0.06	45	~0
10	20	NiCl ₂	0.6	45	6

Technical Accomplishments (cont'd)

Hydrolysis of AB Solutions and Slurries

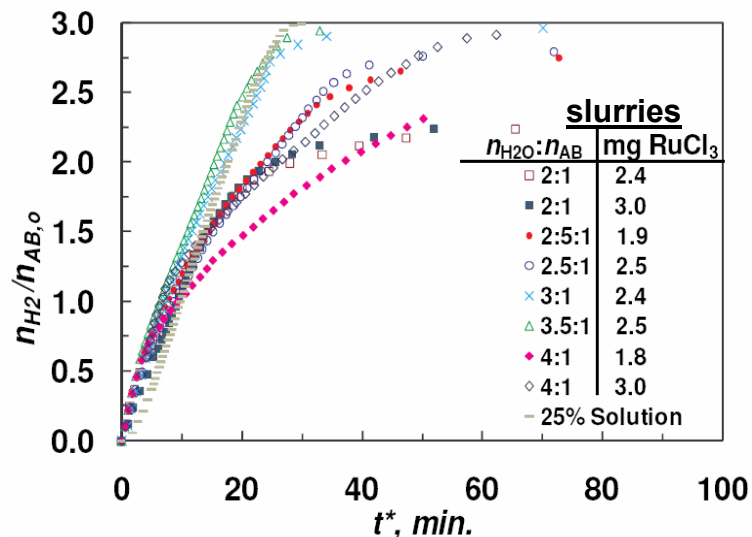
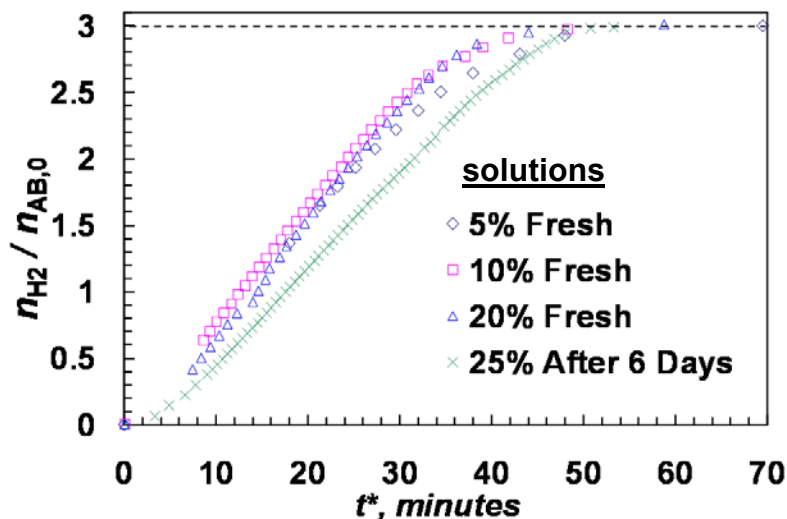

- Catalyst: 3wt% Ru on activated carbon for solution; $RuCl_3$ solution for slurry
- Mixing: mechanical (magnet bead)
- Hydrogen yield was close to 100% up to AB: H_2O of 1:3 (molar base)
- Hydrogen yield was above 92% up to AB: H_2O of 1:2.3
- Hydrogen yield dropped to 78% near stoichiometry (AB: H_2O of 1:2)
- Ammonia emission: 0.08 mole (averaged) NH_3 from 1 mole NH_3BH_3
- Temperature: below 45°C (non-isothermal)
- Reported data: non-isothermal condition was corrected

Technical Accomplishments (cont'd)

AB Slurry Hydrolysis: 7.5 wt% H₂ was measured at room temperature

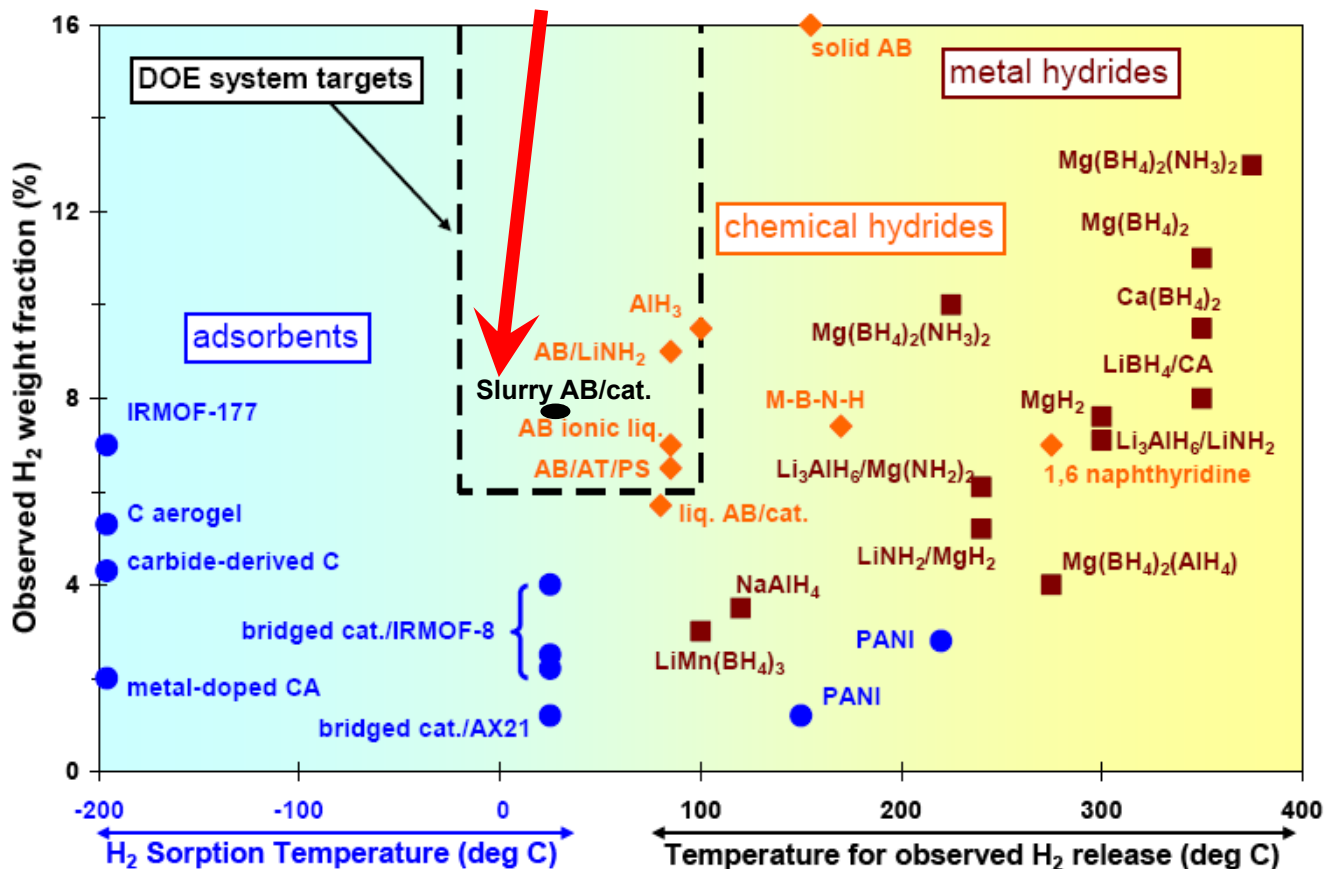
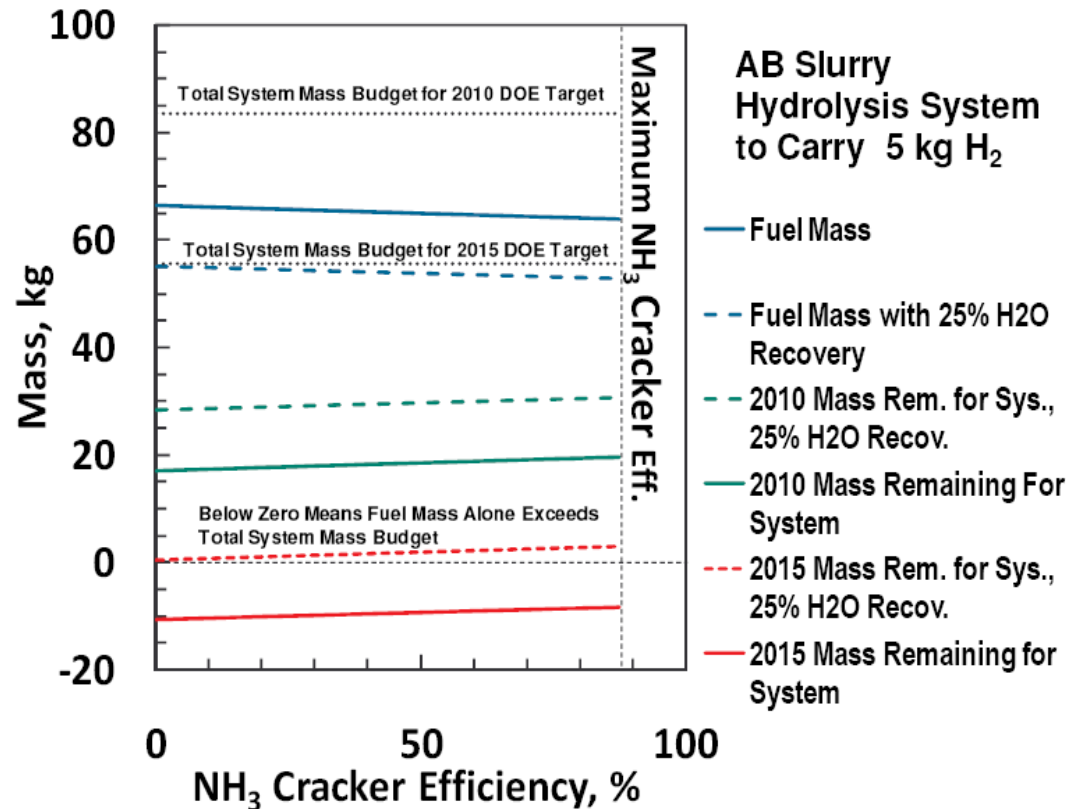

Chart format adapted from G. Thomas, et al., DOE (April 2007)

Technical Accomplishments (cont'd)

Engineering Analysis of AB Slurry Hydrolysis



The AB slurry hydrolysis approach can only meet the DOE's 2015 targets if H₂ yield at low water to AB mixture ratios is improved and onboard ammonia utilization is advanced.

Technical Accomplishments (cont'd)

Potential Analysis of AB Slurry Hydrolysis

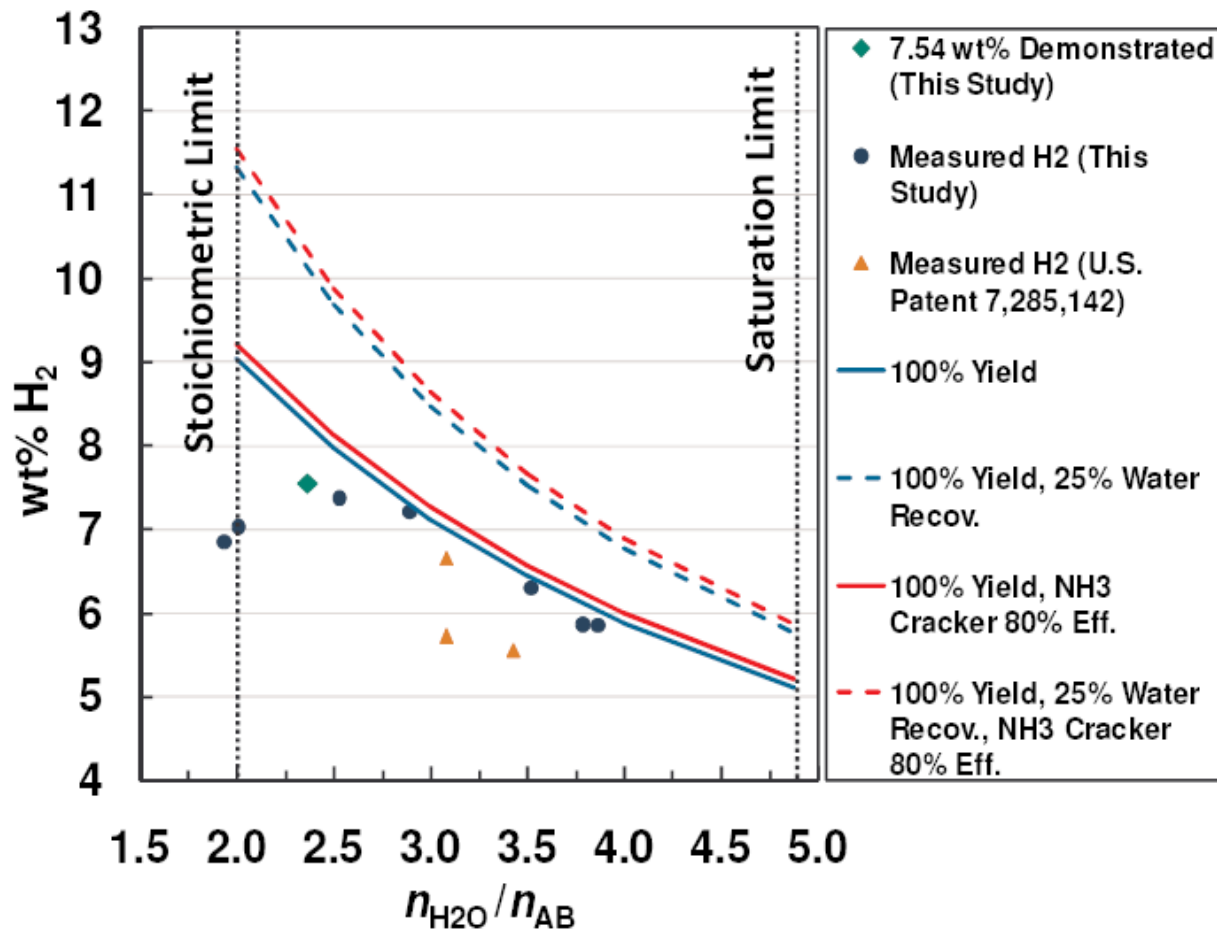

Technical Accomplishments (cont'd)

Long-term Storage Stability of AB Solutions

DOE Targets		2007	2010	2015
Loss of useable H ₂	(g/h)/kgH ₂	1.0	0.1	0.05

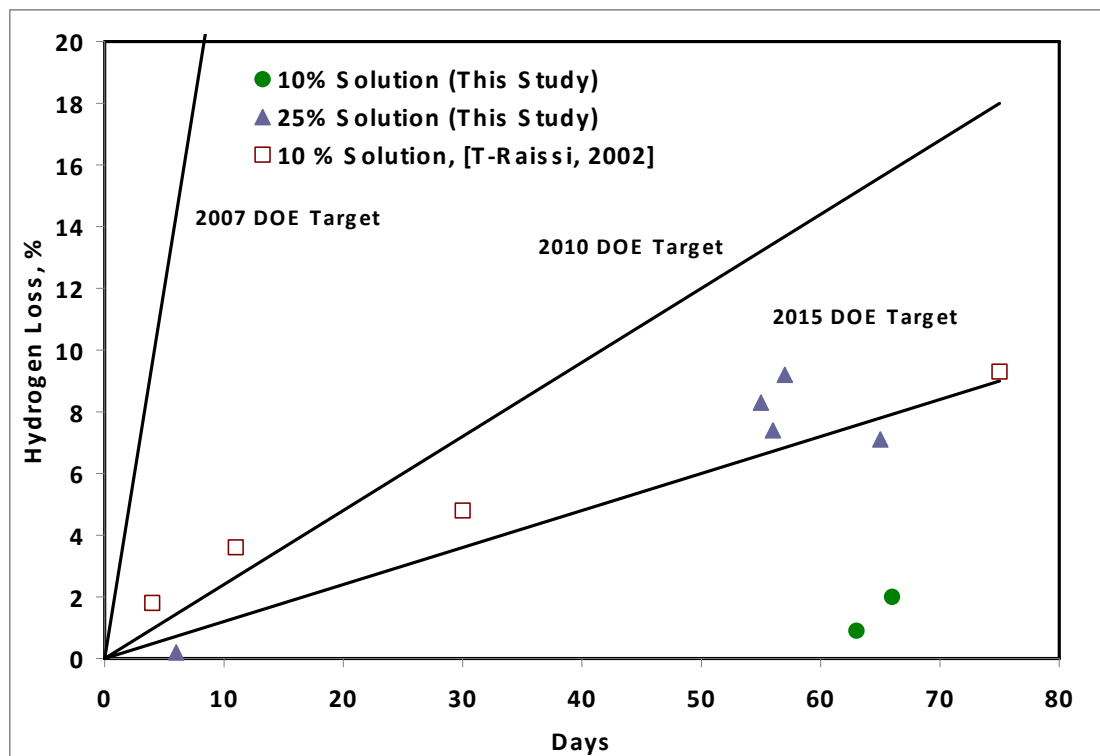

Technical Accomplishments (cont'd)

Isolation of ammoniumtetraborate from AB hydrolysis solution

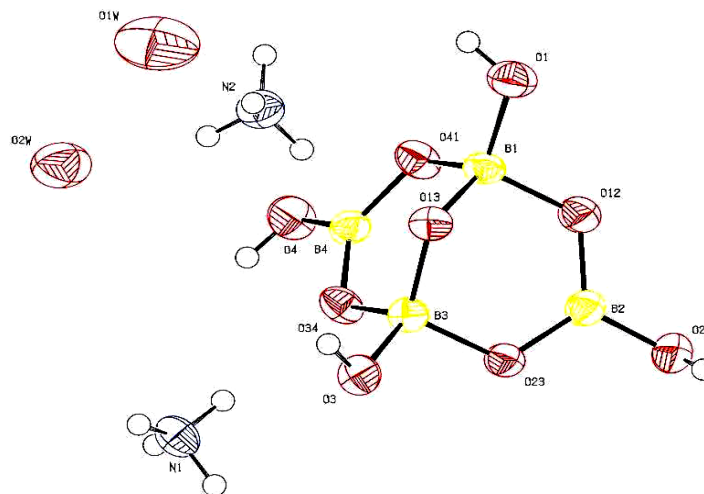
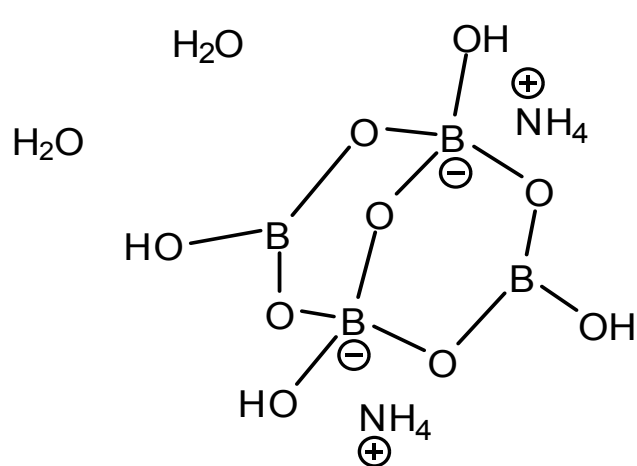
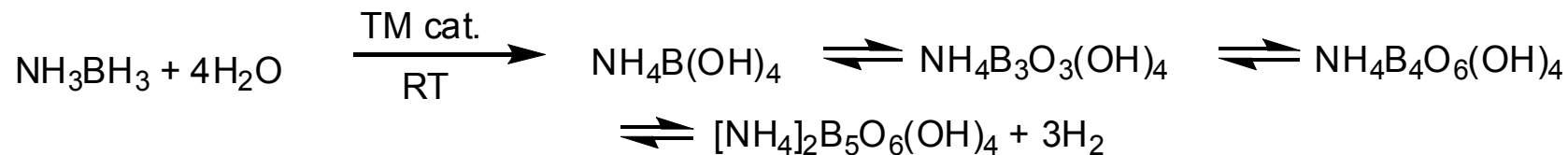

ORTEP diagram of $\{[(\text{NH}_4)_2][\text{B}_4\text{O}_5(\text{OH})_4] \cdot 1.4\text{H}_2\text{O}\}$ at 50% probability

Technical Accomplishments (cont'd)

Regeneration of AB

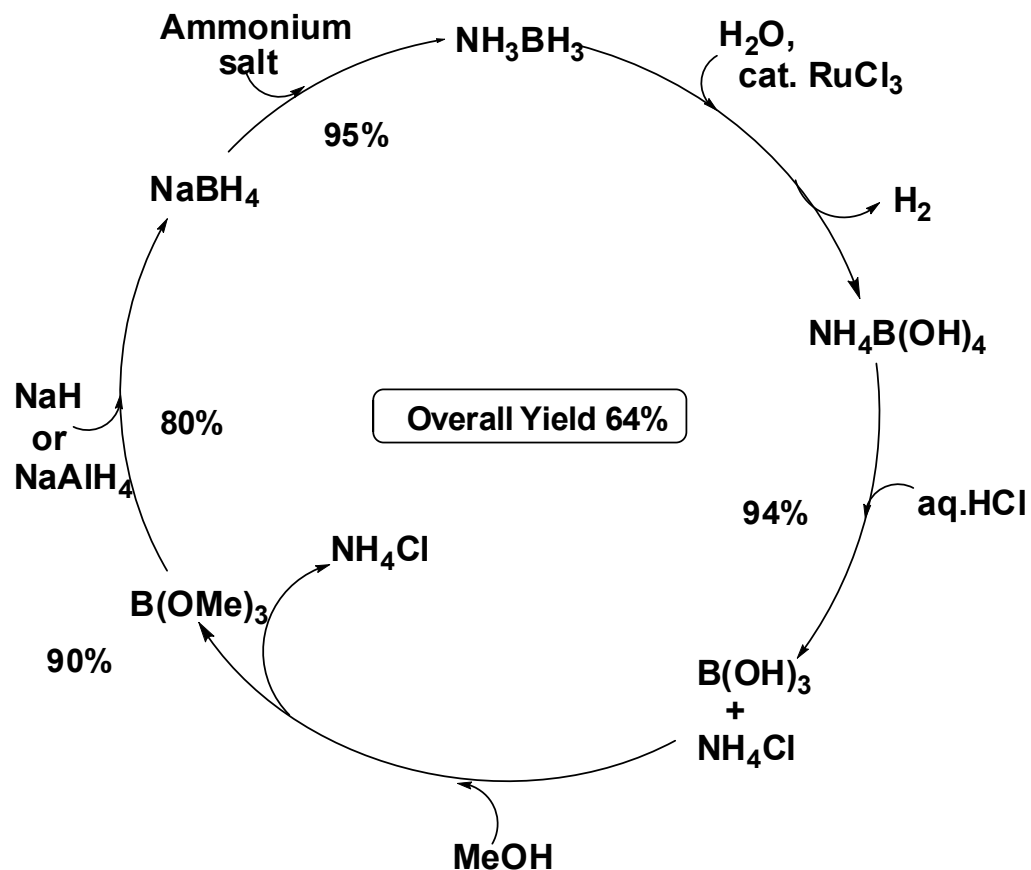

Technical Accomplishments (cont'd)

Noncatalytic AB hydrothermolysis - Experimental

- **Isotopic** experiments were conducted to understand **reaction mechanism** in aqueous AB solutions at high temperatures.
- Argon gas pressure (~10 atm) prevented water boiling, thus allowing for experiments at temperatures 100-170 °C .
- It was shown that heating aqueous AB solutions to 120 °C under modest pressure results in **significant hydrogen release** from AB and water (see next slide).

Experimental apparatus: **Parr reactor**

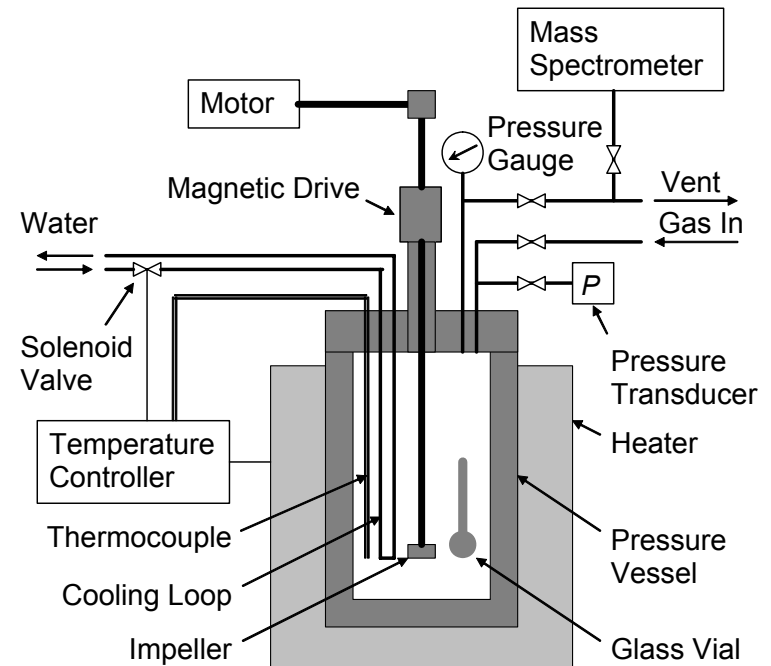

Technical Accomplishments (cont'd)

Figure shows amounts of H₂ and HD evolved from AB/D₂O mixtures, as a function of maximum temperature.

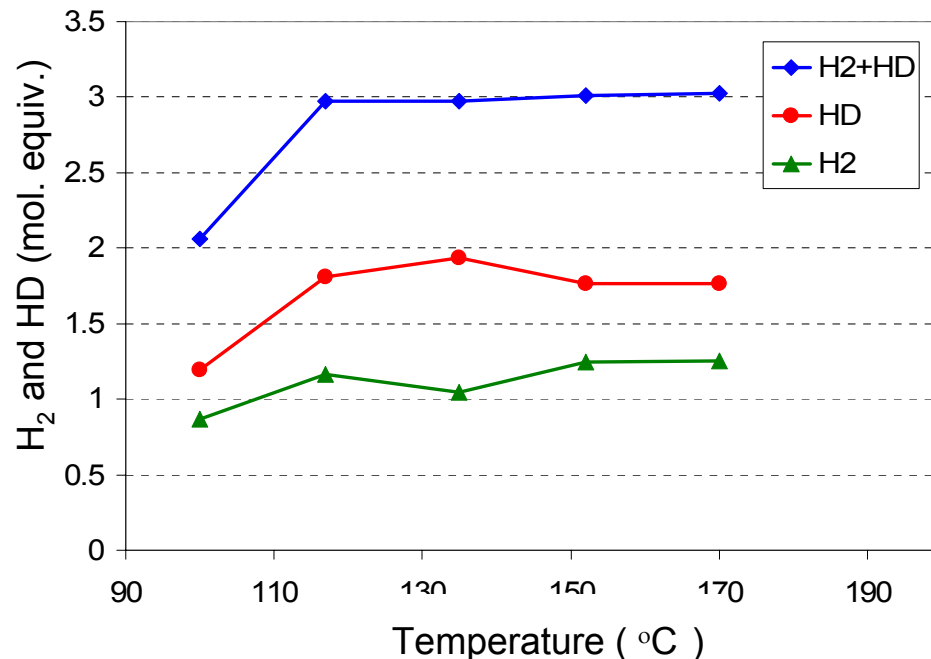
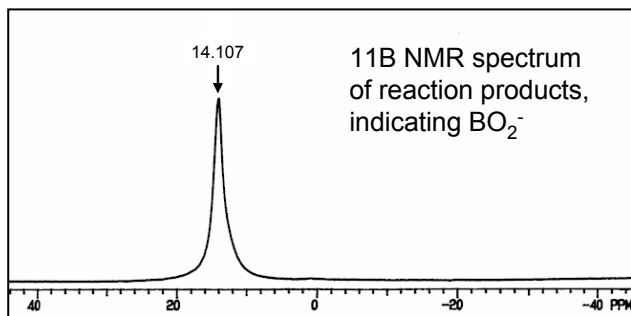

- Heating AB/D₂O solution to 117-170 °C releases 3 mol (H₂ + HD) / mol AB.
- Total hydrogen originating from AB is H₂ + 0.5HD. In the produced 3 equiv. of hydrogen, ~2 equiv. come from AB (more than in **any other method** at T < 135 °C).
- Thus, heating aqueous AB solutions to temperatures >120 °C under modest pressure (<10 atm) is a **promising non-catalytic method** to release H₂ from AB.

Technical Accomplishments (cont'd)

Implications Towards the DOE Targets

- Heating aq. AB solutions to ~120 °C under modest pressure (<10 atm) **without catalyst** provides the same hydrogen yield as catalytic AB hydrolysis, **9.1 wt%** based on AB and **reacted** water:

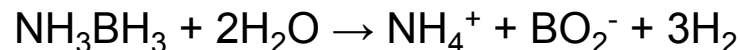

- Use of AB/water **slurry** is expected to provide full (9.1 wt%) H₂ yield for noncatalytic hydrothermolysis, and even higher values if additional operations are involved.
- Comparison with alternative methods for AB hydrolysis involves a tradeoff between the use of higher temperatures and pressures in the proposed novel method, versus the use of catalyst.

Technical Accomplishments (cont'd)

Determination of Initial Optimal Parameters

Design-Expert® Software
 Original Scale
 Total H produced in 1st 24 hrs
 18.7255
 0.0001

X1 = A: Temperature
 X2 = B: pH

Actual Factor
 C: Concentration = 0.93

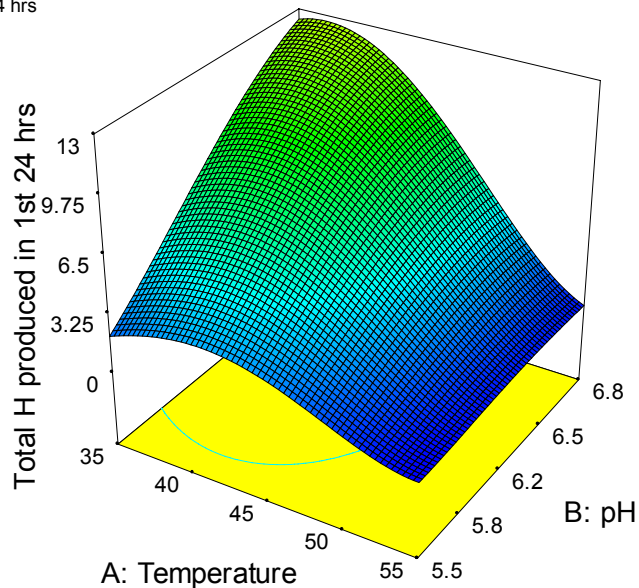

Design-Expert® Software

Desirability
 1
 0

X1 = A: Temperature
 X2 = B: pH

Actual Factor
 C: Concentration = 0.93

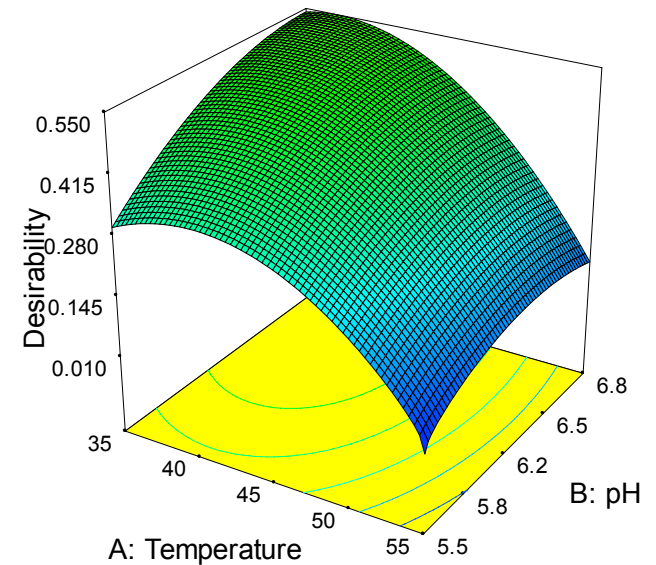

- Central Composite Design for anaerobic hydrogen production
- Optimized using Simplex Method
- pH values are at start of fermentation process after autoclave
- Comprehensive tests in process using automated testing device

Technical Accomplishments (cont'd)

Development of Automated Testing Device

- Automated testing device was developed to accelerate statistical based testing of inoculum and substrate combinations.
- Gas composition is measured automatically with a multiple sampling valve connected to a gas chromatograph.
- Gas volume, temperature, and pH are measured automatically during the fermentation process.
- Goal is to find combinations of inoculum , substrate concentration, pH, and temperature that maximize hydrogen production.

Technical Accomplishments (cont'd)

Solar Pre and Post Processing Design

Current Solar Thermal Test System

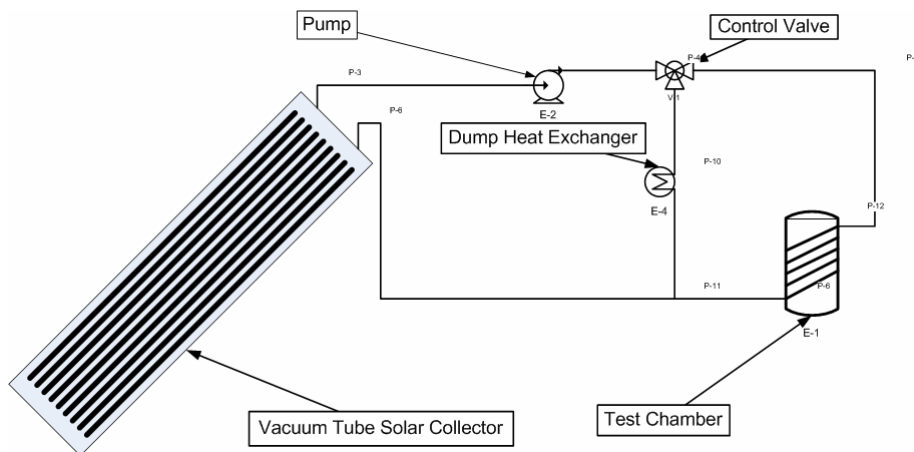

Thermal Response of Full Size System With Thermal Storage and Heat For Ancillary Purposes

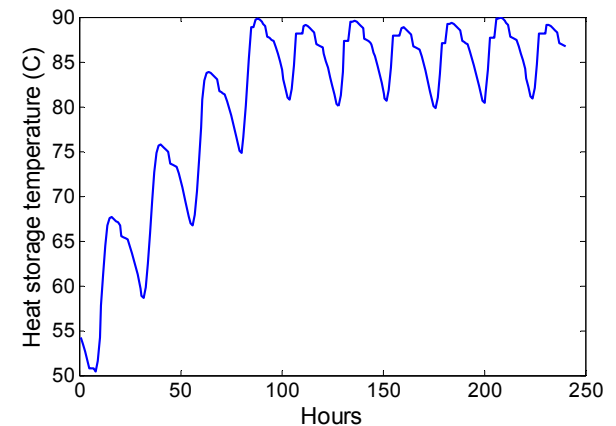

- Current Solar Thermal Test System is being used to investigate effectiveness of pre and post processing and to validate model
- Goal of post processing treatment is to improve suitability of final substrate for use as fertilizer
- Current calculations indicate +90°C temperatures are obtainable for long periods of time
- Excess heat can be used for ancillary purposes such as building heating

Technical Accomplishments (cont'd)

System Energy Balance

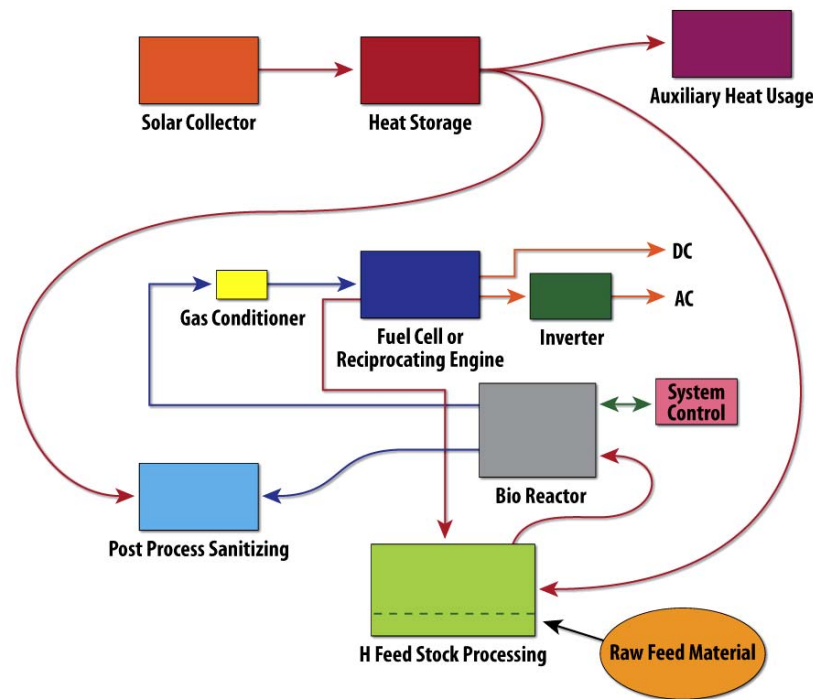

- Modular system for local energy production in remote or Third World locations
- Housed in shipping container
- Hydrogen produced from anaerobic fermentation of waste
- Electricity from fuel cell or reciprocating engine
- Excess heat used for ancillary energy needs

Future Work

- Advance catalytic AB slurry hydrolysis technique to achieve higher than 8 wt% hydrogen storage density.
- Design, construct, test, and analyze a subscale (100-g hydrogen) AB slurry hydrolysis apparatus.
- Improve the overall yield of the current AB recycling to greater than 80%, thus making it energy efficient.
- Examine and incorporate a direct conversion of trimethylborate to AB in high yield and purity to the AB cycle.
- Advance the novel non-catalytic AB hydrothermolysis over a wide range of AB concentrations, at different temperatures and pressures.
- Determine reaction mechanisms and kinetics of hydrogen generation from AB hydrothermolysis, to identify optimum process parameters.
- Develop and test a prototype fuel cell power generation system, based on AB hydrothermolysis.
- Optimize operating values to maximize hydrogen production from multiple inoculums and substrates and energy balance.
- Reduce percentage of water required and investigate supporting mechanisms for substrate.

Project Summary

- We have demonstrated the use of AB slurry hydrolysis with measured H₂ weight fraction within the DOE system targets in terms of gravimetric density and reactor temperature.
- We have demonstrated regeneration of AB in overall 64% yield
- Heating aq. AB solutions to 117-170 °C under modest pressure releases 3 equiv. of hydrogen per mole AB, where ~2 equiv. originate from AB and ~1 equiv. from water. This method is competitive with catalytic AB hydrolysis.
- We have demonstrated the production of hydrogen from waste using fermentation and have developed an initial design for an optimized modular local energy production system.