

2008 DOE Hydrogen, Fuel Cells & Infrastructure Technologies
Program Review

Controlled Hydrogen Fleet and Infrastructure Analysis

Keith Wipke, Senior Engineer and Group Manager

Sam Sprik, Jennifer Kurtz

NREL

June 10, 2008

Project ID# TV-5

This presentation does not contain any proprietary, confidential, or otherwise restricted information

Fuel Cell Vehicle Learning Demonstration

Project Objectives and Targets

- Objectives

- Validate H₂ FC Vehicles and Infrastructure in Parallel
- Identify Current Status and Evolution of the Technology
 - Assess Progress Toward Technology Readiness
 - Provide Feedback to H₂ Research and Development

Key Targets

Performance Measure	2009	2015
Fuel Cell Stack Durability	2000 hours	5000 hours
Vehicle Range	250+ miles	300+ miles
Hydrogen Cost at Station	\$3/gge	\$2-3/gge



Solar Electrolysis Station, Sacramento, CA

Photo: NREL

Project Overview

Timeline

- Project start: FY03
- Project end: FY10
- ~70% of Task III complete (see timeline slide)

Budget

- Context: Overall DOE project is ~\$170M project over 5 years
 - Equal investment by industry
- NREL funding prior to FY07 : \$2192K
- NREL FY07 funding: \$850K
- NREL FY08 funding: \$850K

Partners

- See partner slide

Tech. Val. Barriers

- Vehicles** – lack of controlled & on-road H₂ vehicle and FC system data
- Storage** – technology does not yet provide necessary 300+ mile range
- Hydrogen Refueling Infrastructure** – cost and availability
- Maintenance and Training Facilities** – lack of facilities and trained personnel
- Codes and Standards** – lack of adoption/validation
- Hydrogen Production from Renewables** – need for cost, durability, efficiency data for vehicular application
- H₂ and Electricity Co-Production** – cost and durability

Project Timeline and Major Milestones

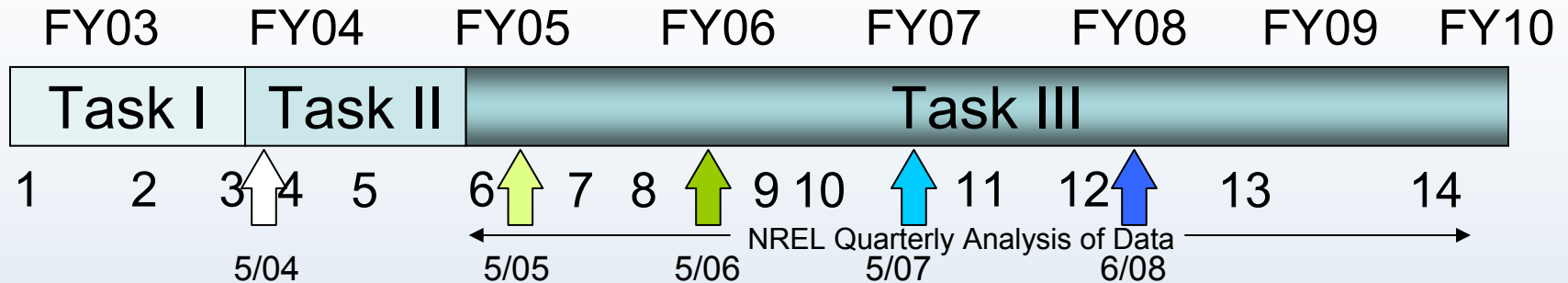

- **Task I – Project Preparation [100% Complete]**
 - 1 Support development of RFP, statement of objectives (Appendix C)
 - 2 Bidder’s meeting in Detroit – launch of RFP
 - 3 Create data analysis plan and presentation for discussion with industry
- **Task II – Project Launch [100% Complete]**
 - 4 Announcement of successful bidders (4/04)
 - 5 Kick-off meetings and cooperative agreement awards
- **Task III – Data Analysis and Feedback to R&D activities (partial list) [70% Complete]**
 - 6 Preliminary data collection, analysis, and first quarterly assessment report
 - 7 Demonstrate FCVs that achieve 50% higher fuel economy than gasoline vehicles
 - 8 Publication of first “composite data products”
 - 9 Evaluate FC stack time to 10% voltage degradation relative to 1000-hour target
 - 10 Decision for purchase of additional vehicles based on performance, durability, cost
 - 11 Preliminary evaluation of dominant real-world factors influencing FC degradation
 - 12 Introduction of 2nd generation FC systems into vehicles begins
 - 13 FCVs demonstrate 250-mile range without impacting passenger cargo compartment
 - 14 Validate FCVs with 2,000 hour durability and \$3.00/gge (based on volume production)



Industry Partners: 4 Automaker/Energy-Supplier Teams; Rollout: 2nd Generation FC Introduction in 2008 Has Begun

Gen 1



Gen 1

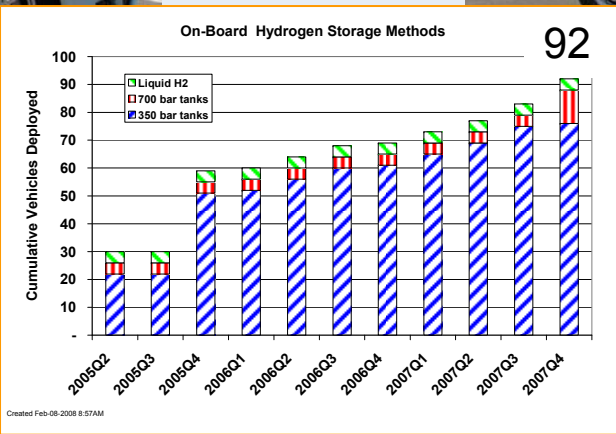

Gen 2



Gen 1 & 2



DOE Learning Demo Fleet Has Surpassed 50,000 Vehicle Hours and 1.1 Million Miles

Vehicle Hours: All OEMs Combined
Through 2007 Q4

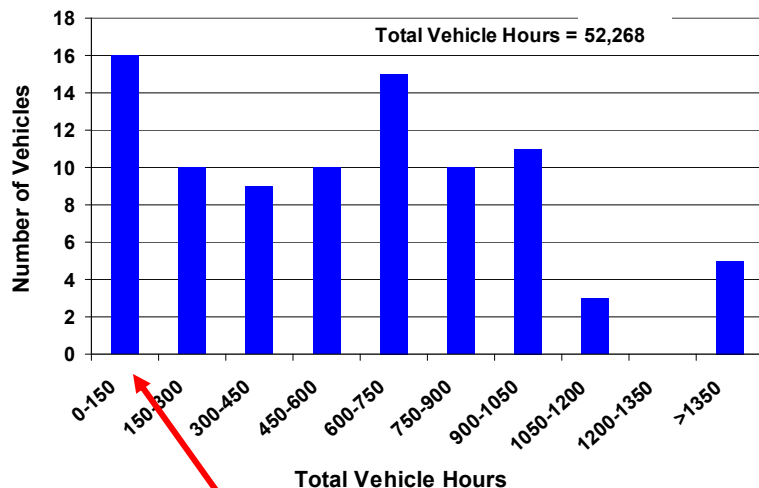

Created: Feb-15-08

Gen 2 vehicle introduction now appears as the 2nd bulge at low hours/miles

Vehicle Miles: All OEMs Combined
Through 2007 Q4

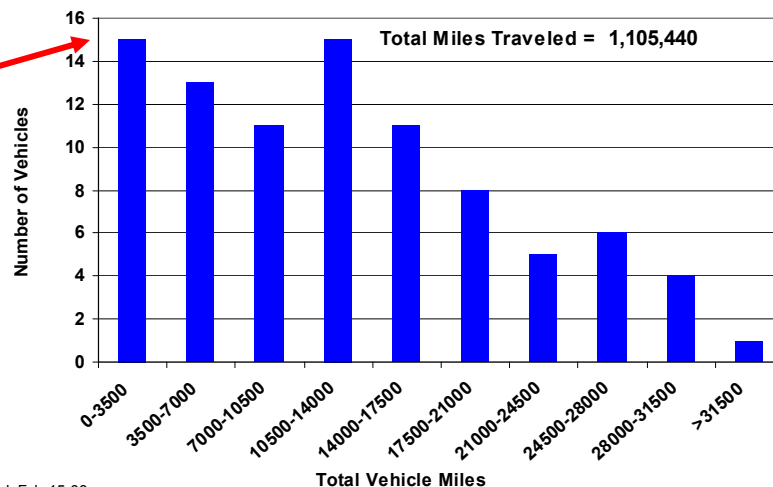

Created: Feb-15-08

Majority of Project's Fixed Infrastructure to Refuel Vehicles Has Been Installed – Examples of 4 Types

Mobile Refueler
Sacramento, CA

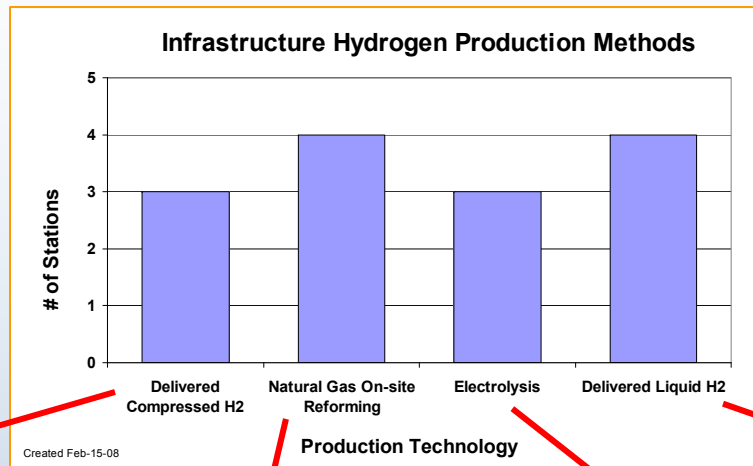

Delivered Liquid, 700 bar
Irvine, CA



Steam Methane Reforming
Oakland, CA



Water Electrolysis
Rosemead, CA

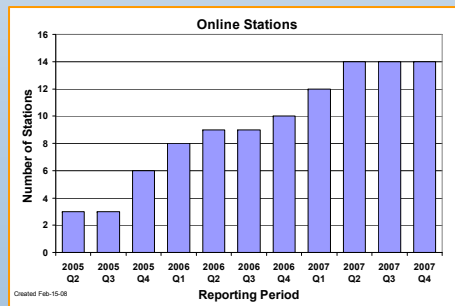

Recent station additions include:
SMUD (BP) and White Plains, NY (Shell).
15 stations now deployed

Total of >40,000 kg H2
produced or dispensed

Refueling Stations Test Performance in Various Climates; Learning Demo Comprises ~1/3 of all US Stations

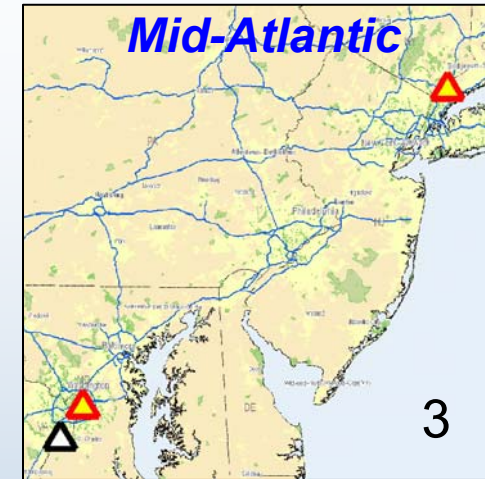
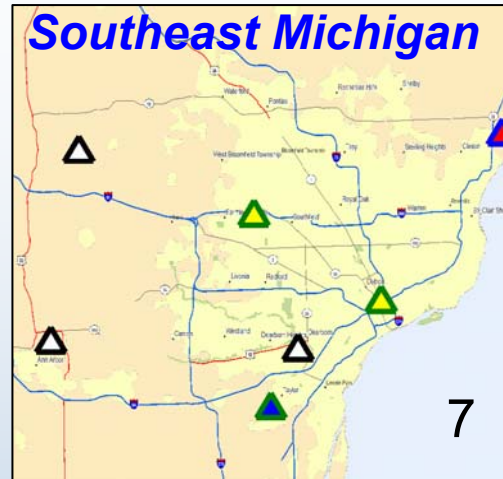

- Legend**
- ▲ Chevron & Hyundai/Kia
 - ▲ DaimlerChrysler & BP
 - ▲ Ford & BP
 - ▲ General Motors & Shell
 - ▲ Air Products
 - ▲ Other Companies

Project Approach

- Provide facility and staff for securing and analyzing industry sensitive data
 - NREL Hydrogen Secure Data Center (HSDC)
- Perform analysis and simulation using detailed data in HSDC to:
 - Evaluate current status and progress toward targets
 - Feedback current technical challenges and opportunities into DOE H₂ R&D program
 - Provide analytical results to originating companies on their own data (detailed data products)
 - Collaborate with industry partners on new and more detailed analyses
- Publish/present progress of project to public and stakeholders (composite data products)



Approach: Providing Data Analysis and Results for Both the Public and the Industry Project Teams

Hydrogen Secure Data Center (HSDC)

- Located at NREL: Strictly Controlled Access
- Detailed Analyses, Data Products, Internal Reports

Raw Data,
Reports

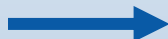

Composite Data Products

- Aggregate data results for public
- No confidential information

Detailed Data Products

- Only shared with company/team which originated the data

Accomplishment: Eleven Quarters of Data Analyzed to Date

Current Status of Data Reporting to the Hydrogen Secure Data Center at NREL

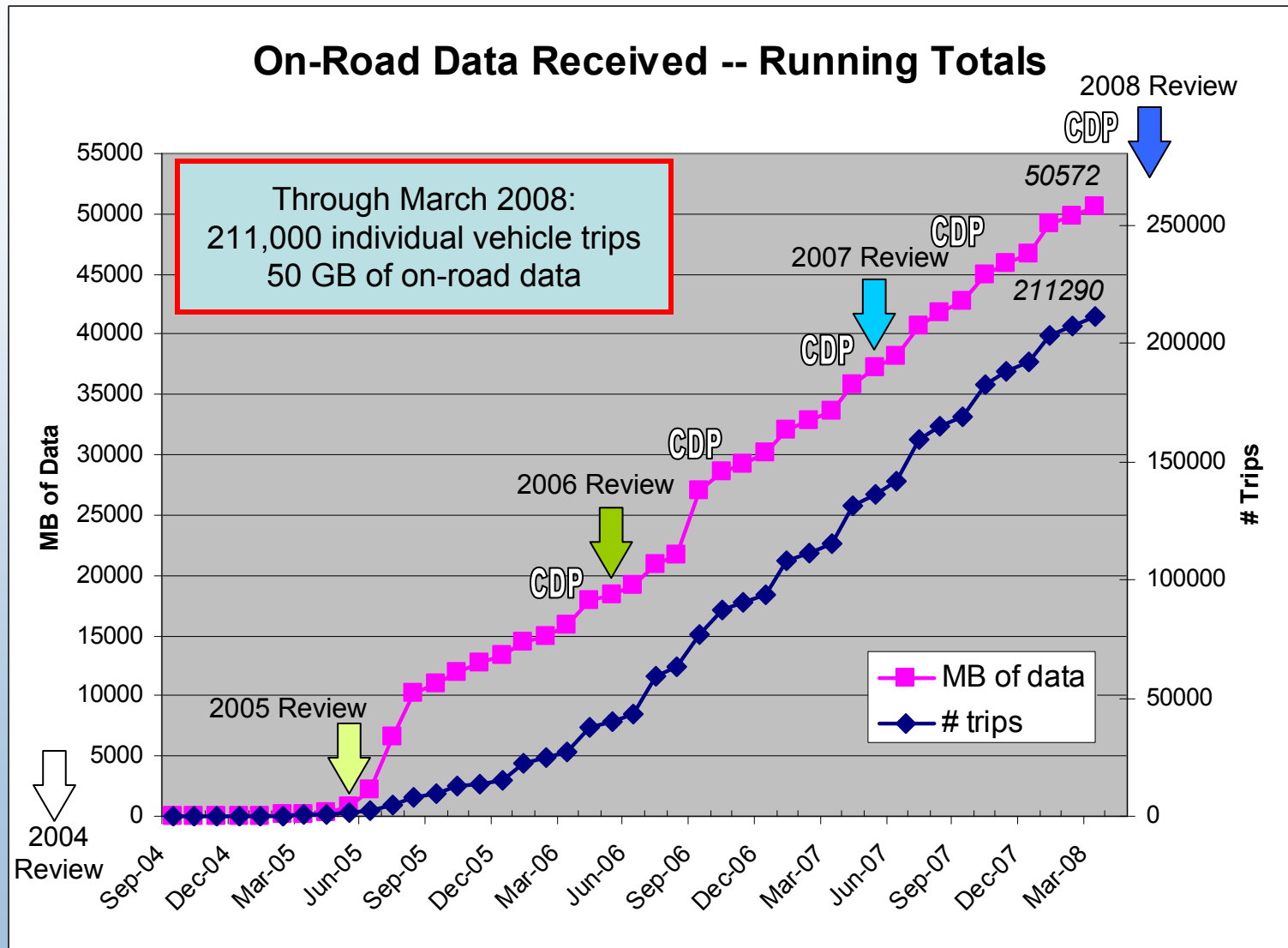

Accomplishment: Generated All Results Using NREL-Developed GUI – Fleet Analysis Toolkit (FAT)

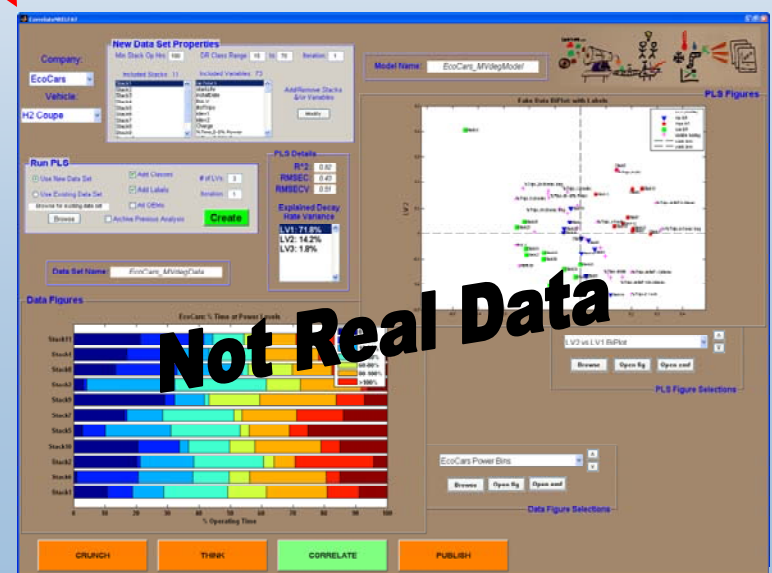
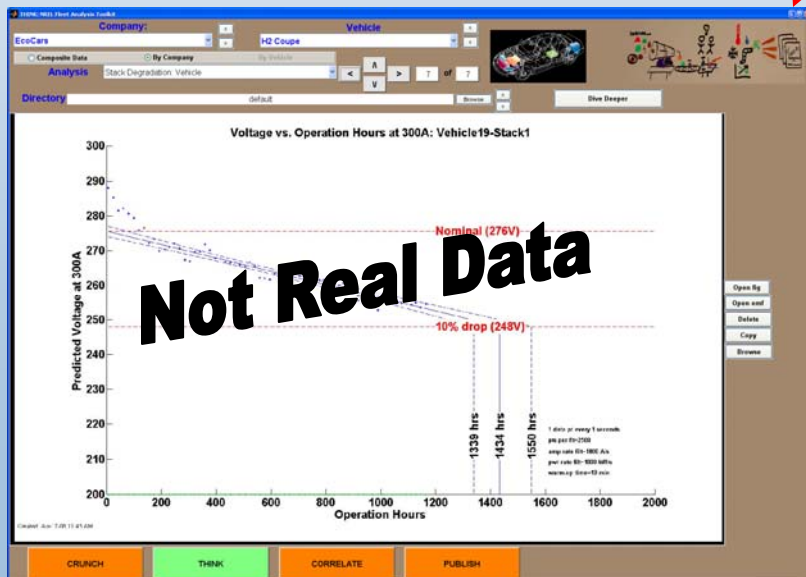

Accomplishment: In the Last Year Published Fall 2007 and Spring 2008 CDP Results through Conferences, Progress Reports, and Journals

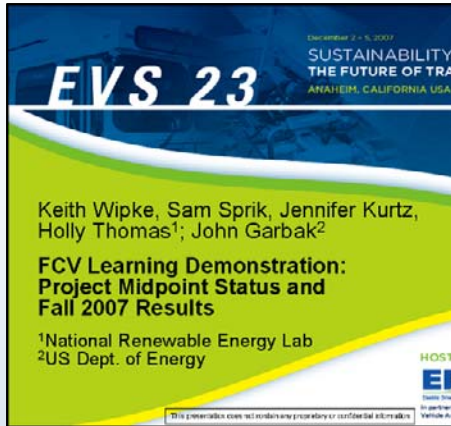

EVS 23
SUSTAINABILITY:
THE FUTURE OF TRANSPORTATION
ANAHEIM, CALIFORNIA USA

September 2-4, 2007

FCV Learning Demonstration: Project Midpoint Status and Fall 2007 Results

Keith Wipke, Sam Sprik, Jennifer Kurtz, Holly Thomas¹, John Garbak²

¹National Renewable Energy Lab
²US Dept. of Energy

This presentation does not contain any proprietary or confidential information



FCV Learning Demonstration: Project Midpoint Status and Fall 2007 Results

Abstract

Keywords

1. Introduction

This presentation provides an overview of the FCV Learning Demonstration project, including the status of the project as of the end of the fall 2007 results period. The project is a multi-year effort to demonstrate the performance of fuel cell vehicles under real-world conditions. The project involves the development of a fleet of vehicles, the operation of the fleet, and the collection and analysis of data. The project is led by the National Renewable Energy Laboratory (NREL) in collaboration with the U.S. Department of Energy (DOE).

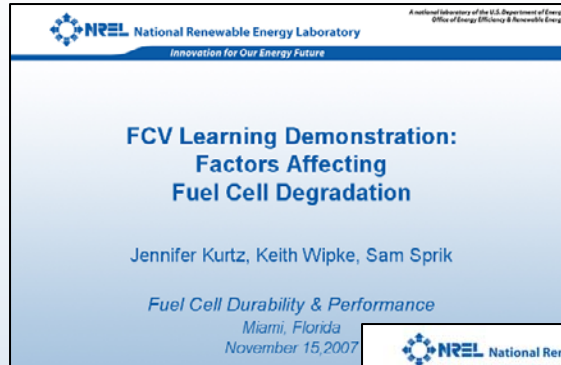

FCV Learning Demonstration: Factors Affecting Fuel Cell Degradation

Jennifer Kurtz, Keith Wipke, Sam Sprik

Fuel Cell Durability & Performance
Miami, Florida
November 15, 2007

This presentation does not contain any proprietary or confidential information

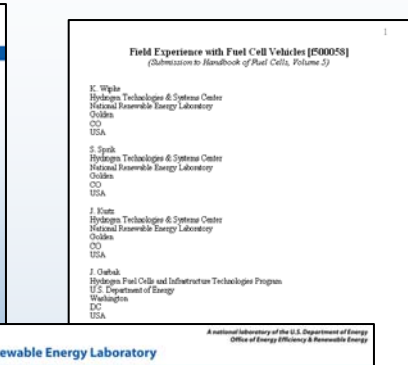

Field Experience with Fuel Cell Vehicles (FCV) Series
(Subseries to Handbook of Fuel Cells, Volume 3)

K. Wipke
Hydrogen Technology & Systems Center
National Renewable Energy Laboratory
Golden, CO
USA

S. Sprik
Hydrogen Technology & Systems Center
National Renewable Energy Laboratory
Golden, CO
USA

J. Kurtz
Hydrogen Technology & Systems Center
National Renewable Energy Laboratory
Golden, CO
USA

J. Garbak
Hydrogen Fuel Cells and Infrastructure Technology Program
U.S. Department of Energy
Washington, DC
USA

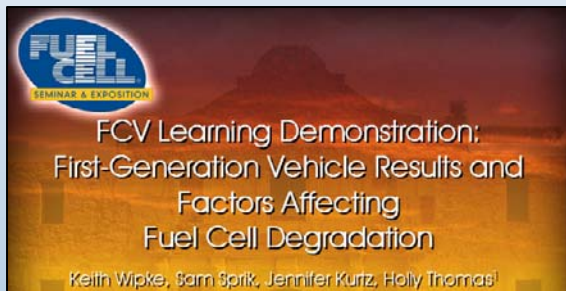

FCV Learning Demonstration: First-Generation Vehicle Results and Factors Affecting Fuel Cell Degradation

Keith Wipke, Sam Sprik, Jennifer Kurtz, Holly Thomas¹

This presentation does not contain any proprietary or confidential information



Learning Demonstration Interim Progress Report - Summer 2007

Technical Report
NREL/TP-560-41949
July 2007

K. Wipke, S. Sprik, H. Thomas, C. Welch, and J. Kurtz

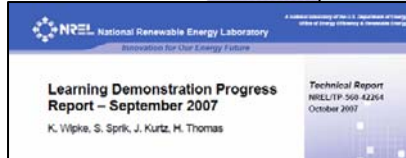

Learning Demonstration Progress Report - September 2007

Technical Report
NREL/TP-560-42264
October 2007

K. Wipke, S. Sprik, J. Kurtz, H. Thomas

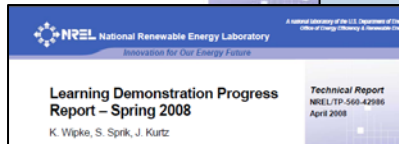

Learning Demonstration Progress Report - Spring 2008

Technical Report
NREL/TP-560-42966
April 2008

K. Wipke, S. Sprik, J. Kurtz

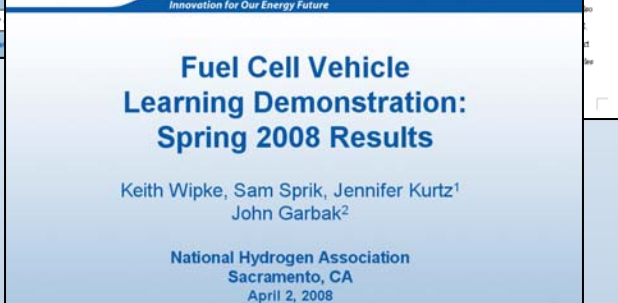

Fuel Cell Vehicle Learning Demonstration: Spring 2008 Results

Keith Wipke, Sam Sprik, Jennifer Kurtz¹, John Garbak²

National Hydrogen Association
Sacramento, CA
April 2, 2008

This presentation does not contain any proprietary or confidential information

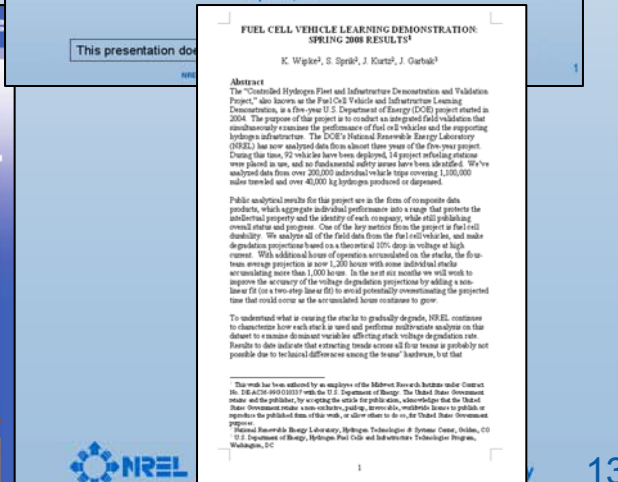

FUEL CELL VEHICLE LEARNING DEMONSTRATION: SPRING 2008 RESULTS¹

K. Wipke¹, S. Sprik¹, J. Kurtz¹, J. Garbak²

Abstract

The "Controlled Hydrogen Fleet and Infrastructure Demonstration and Validation Program" also known as the Fuel Cell Vehicle and Infrastructure Learning Demonstration, is a five-year U.S. Department of Energy (DOE) project started in 2004. The purpose of this project is to conduct an integrated field validation that simultaneously examines the performance of fuel cell vehicles and the supporting hydrogen infrastructure. The DOE's National Renewable Energy Laboratory (NREL) has now analyzed data from almost three years of the five-year project. During the time, 92 vehicles have been deployed, 14 project refueling stations have placed in use, and no final-mile delivery ranges have been achieved. We have analyzed data from over 200,000 individual vehicle trips covering 1,550,000 miles traveled and over 40,000 kg hydrogen produced or dispensed.

Public analytical results for the project are in the form of composite data products, which aggregate individual performance into a single data product that summarizes the overall status and progress of the project, while still publishing overall status and progress. One of the key sections from the report is fuel cell durability. We analyze all of the field data from the fuel cell vehicles, and make degradation projections based on a theoretical 10% drop in voltage at high current. With additional hours of operation accumulated on the stack, the drop-in average projection is now 1,200 hours with some individual stacks accumulating more than 1,000 hours. In the next six months we will work to improve the accuracy of the voltage degradation projection by adding a new layer of data to a new-step linear fit to avoid potentially overestimating the projected time that could occur at the unobserved lower current to power.

To understand what is causing the stack to gradually degrade, NREL continues to characterize low stack stack in use and perform multi-scale analysis on the stack to examine dominant variable affecting stack voltage degradation rate. Results to date indicate that extracting trends across all to name is probably not possible due to technical differences among the team's hardware, but that

The work has been authored by employees of Midwest Research Institute under contract to the U.S. Department of Energy. The United States Government is authorized to reproduce and retransmit this work for government purposes, not withstanding any copyright notation that may appear hereon. This work is made available under the Creative Commons Attribution 3.0 license. For more information, see the Creative Commons Attribution 3.0 license at <http://creativecommons.org/licenses/by/3.0/>.

¹National Renewable Energy Laboratory, Hydrogen Technology & Systems Center, Golden, CO
²U.S. Department of Energy, Hydrogen Fuel Cells and Infrastructure Technology Program, Washington, DC

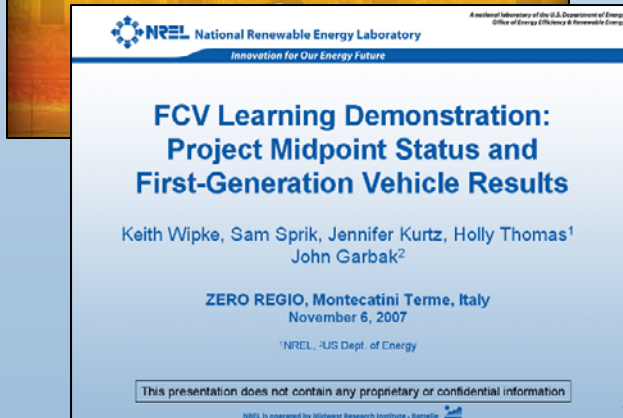

FCV Learning Demonstration: Project Midpoint Status and First-Generation Vehicle Results

Keith Wipke, Sam Sprik, Jennifer Kurtz, Holly Thomas¹, John Garbak²

ZERO REGIO, Montecatini Terme, Italy
November 6, 2007

¹NREL, ²US Dept. of Energy

This presentation does not contain any proprietary or confidential information



Accomplishment: NREL Web Site Provides Direct Access to All Composite Data Products (47), Reports, and Presentations

http://www.nrel.gov/hydrogen/cdp_topic.html

NREL National Renewable Energy Laboratory
Innovation for Our Energy Future

ABOUT NREL | SCIENCE & TECHNOLOGY | TECHNOLOGY TRANSFER | APPLYING TECHNOLOGIES | LEARNING ABOUT RENEWABLES

Hydrogen & Fuel Cells Research

Hydrogen Research Home

Composite Data Products by Topic
The public technical analysis results from DOE's Controlled Hydrogen Fleet and Infrastructure Demonstration and Validation Project are generated in the form of composite data products (CDPs). The following CDPs, which are organized by topic, are offered in both PowerPoint and JPEG formats.

If these technical results are reproduced in your own documents or presentations, please provide appropriate reference to the U.S. Department of Energy's National Renewable Energy Laboratory.

Fuel Cell Stack Durability

- Fuel Cell Stack Hours Accumulated and Projected Hours to 10% Stack Voltage Degradation, CDP #1, 2/26/08 ([PowerPoint 433 KB](#)) ([JPEG 226 KB](#))
- Primary Factors Affecting Learning Demo Fleet Fuel Cell Degradation, CDP #40, 2/21/08 ([PowerPoint 430 KB](#)) ([JPEG 144 KB](#))
- Primary Factors Affecting Learning Demo Team Fuel Cell Degradation, CDP #49, 2/27/08 ([PowerPoint 437 KB](#)) ([JPEG 167 KB](#))

Fuel Cell Vehicle Range and Driving Behavior

- Fuel Cell Vehicle Range, CDP #2, 2/15/08 ([PowerPoint 423 KB](#)) ([JPEG 137 KB](#))
- Percentage of Theoretical Driving Range Between Refuelings, CDP #33, 2/15/08 ([PowerPoint 428 KB](#)) ([JPEG 114 KB](#))
- Effective Fuel Cell Vehicle Range, CDP #34, 2/15/08 ([PowerPoint 425 KB](#)) ([JPEG 86 KB](#))
- Trip Length, CDP #47, 2/27/08 ([PowerPoint 427 KB](#)) ([JPEG 82 KB](#))
- Fuel Cell System Energy, CDP #55, 2/27/08 ([PowerPoint 426 KB](#)) ([JPEG 68 KB](#))

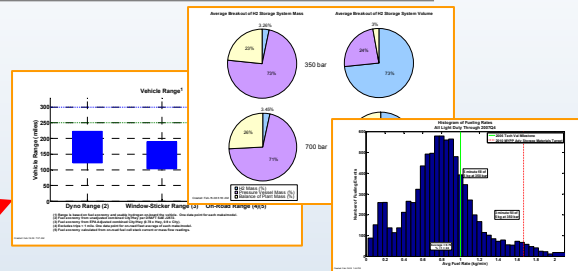

http://www.nrel.gov/hydrogen/proj_learning_demo.html

Presentations and Publications
Some of the following documents are available as Adobe Acrobat PDFs. [Download Adobe Reader.](#)

2008

- Learning Demonstration Progress Report—Spring 2008 ([PDF 1 MB](#)), K. Wipke, S. Sprick, and J. Kurtz. (April 2008)
- Fuel Cell Vehicle Learning Demonstration: Spring 2008 Results Presentation ([PDF 2 MB](#)) and Paper Preprint ([PDF 475 KB](#)), K. Wipke, S. Sprick, J. Kurtz, and J. Garbak. Presentation and paper prepared for the National Hydrogen Association Annual Hydrogen Conference (March 2008)

2007

- FCV Learning Demonstration: Project Midpoint Status and Fall 2007 Results Presentation ([PDF 1.5 MB](#)) and Paper Preprint ([PDF 617 KB](#)), K. Wipke, S. Sprick, J. Kurtz, H. Thomas, and J. Garbak. Presentation and paper prepared for EVS 23, Anaheim, CA (December 2007)
- FCV Learning Demonstration: Factors Affecting Fuel Cell Degradation (Presentation) ([PDF 1.2 MB](#)), J. Kurtz, K. Wipke, and S. Sprick. Presentation prepared for Fuel Cell Durability & Performance, Miami, Florida. (November 2007)
- Learning Demonstration Progress Report—September 2007 ([PDF 842 KB](#)), K. Wipke, S. Sprick, J. Kurtz, and H. Thomas. (November 2007)
- FCV Learning Demonstration: Project Midpoint Status and First-Generation Vehicle Results ([PDF 1.6 MB](#)), K. Wipke, S. Sprick, J. Kurtz, H. Thomas, J. Garbak. Presentation prepared for ZERO REGIO, Montecatini Terme, Italy. (November 2007)
- 2007 Annual Progress Report for NREL's "Controlled Hydrogen Fleet and Infrastructure Analysis Project," System Analysis Section V1.D.1 ([PDF 903 KB](#)), K. Wipke, S. Sprick, H. Thomas, C. Welch, J. Kurtz. (November 2007)
- FCV Learning Demonstration: First-Generation Vehicle Results and Factors Affecting Fuel Cell

NREL National Renewable Energy Laboratory
Innovation for Our Energy Future

Learning Demonstration Progress Report - Spring 2008

K. Wipke, S. Sprick, J. Kurtz

Technical Report
NREL/TP-560-42985
April 2008

National Hydrogen Association
Sacramento, CA
April 2, 2008

NREL, US Dept. of Energy

NREL National Renewable Energy Laboratory
Innovation for Our Energy Future

Fuel Cell Vehicle Learning Demonstration: Spring 2008 Results

Keith Wipke, Sam Sprick, Jennifer Kurtz,
John Garbak

National Hydrogen Association
Sacramento, CA
April 2, 2008

NREL, US Dept. of Energy

Accomplishment: Restructured CDP Web Site Files to Allow Tracking of Most Frequently Accessed Technical Results

Sustained activity in last 5-6 months

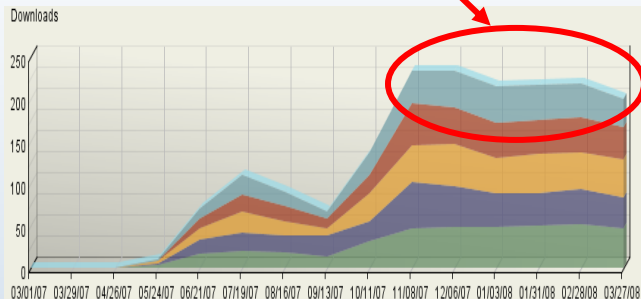

Top 5 CDPs viewed

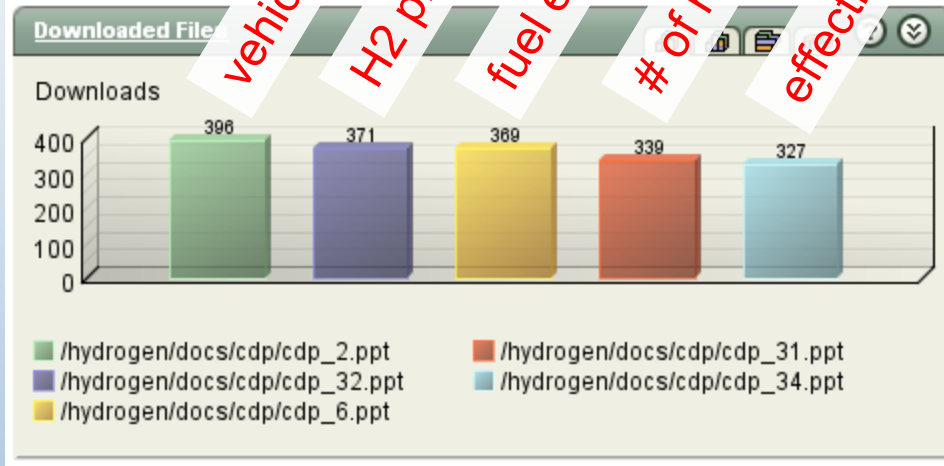

3/1/07

4/1/08



Summer 2007 Progress Report Downloaded 2,138 times; 6th most popular download from NREL's H2 website

Visitor Summary

Visitors	703
Visitors Who Visited Once	605
Visitors Who Visited More Than Once	98
Average Visits per Visitor	1.62

http://www.nrel.gov/hydrogen/cdp_topic.html

Visit Summary

Visits	1,136
Average per Day	2
Average Visit Duration	-
Median Visit Duration	-
International Visits	12.06%
Visits of Unknown Origin	51.94%
Visits from Your Country: United States (US)	36.00%

Dynamometer and On-Road Fuel Economy from Gen 1 Learning Demonstration Vehicles

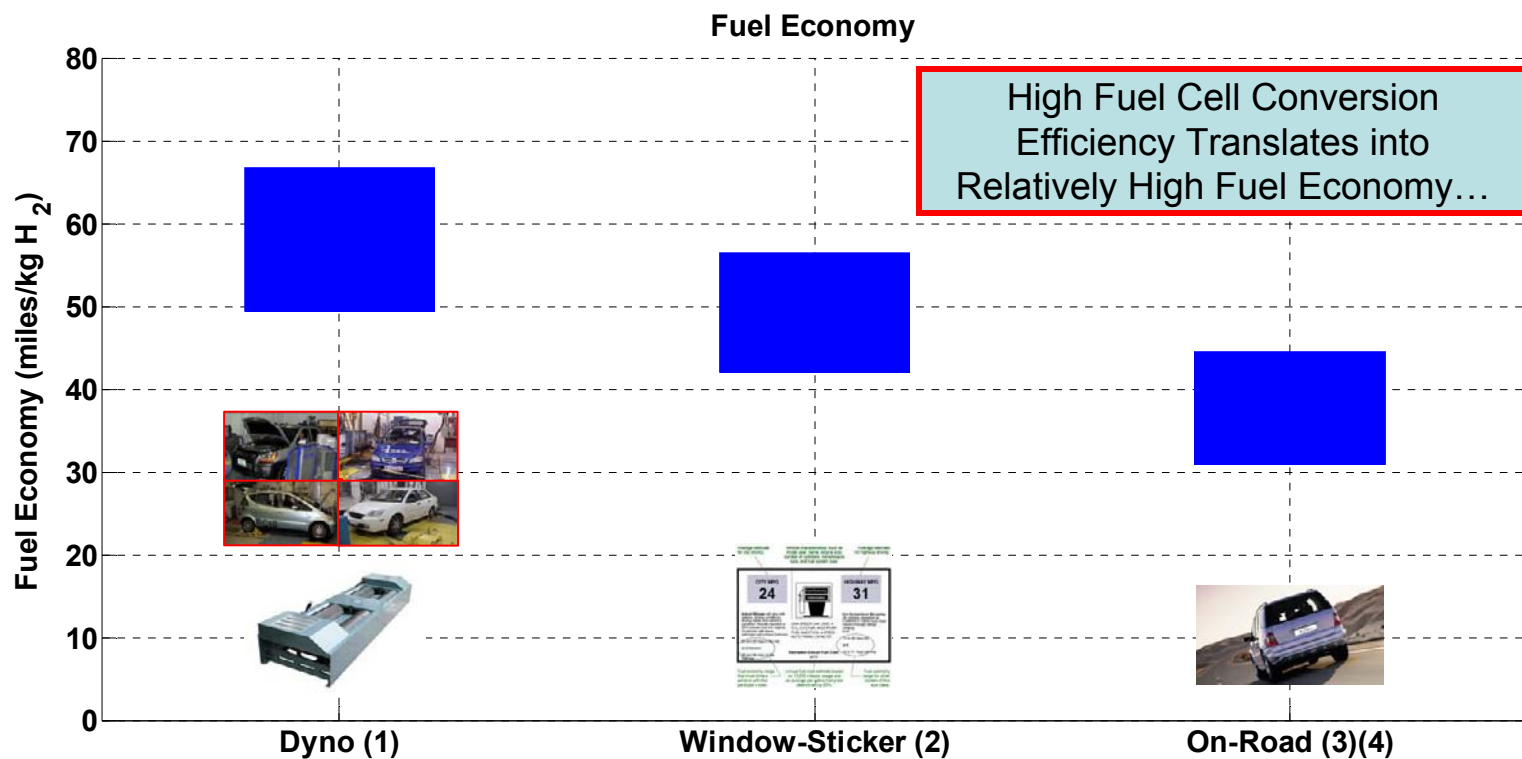

(1) One data point for each make/model. Combined City/Hwy fuel economy per DRAFT SAE J2572.

(2) Adjusted combined City/Hwy fuel economy (0.78 x Hwy, 0.9 x City).

(3) Excludes trips < 1 mile. One data point for on-road fleet average of each make/model.

(4) Calculated from on-road fuel cell stack current or mass flow readings.

Gen 1 Vehicle Range Based on Dyno Results and Usable H₂ Fuel Stored On-Board

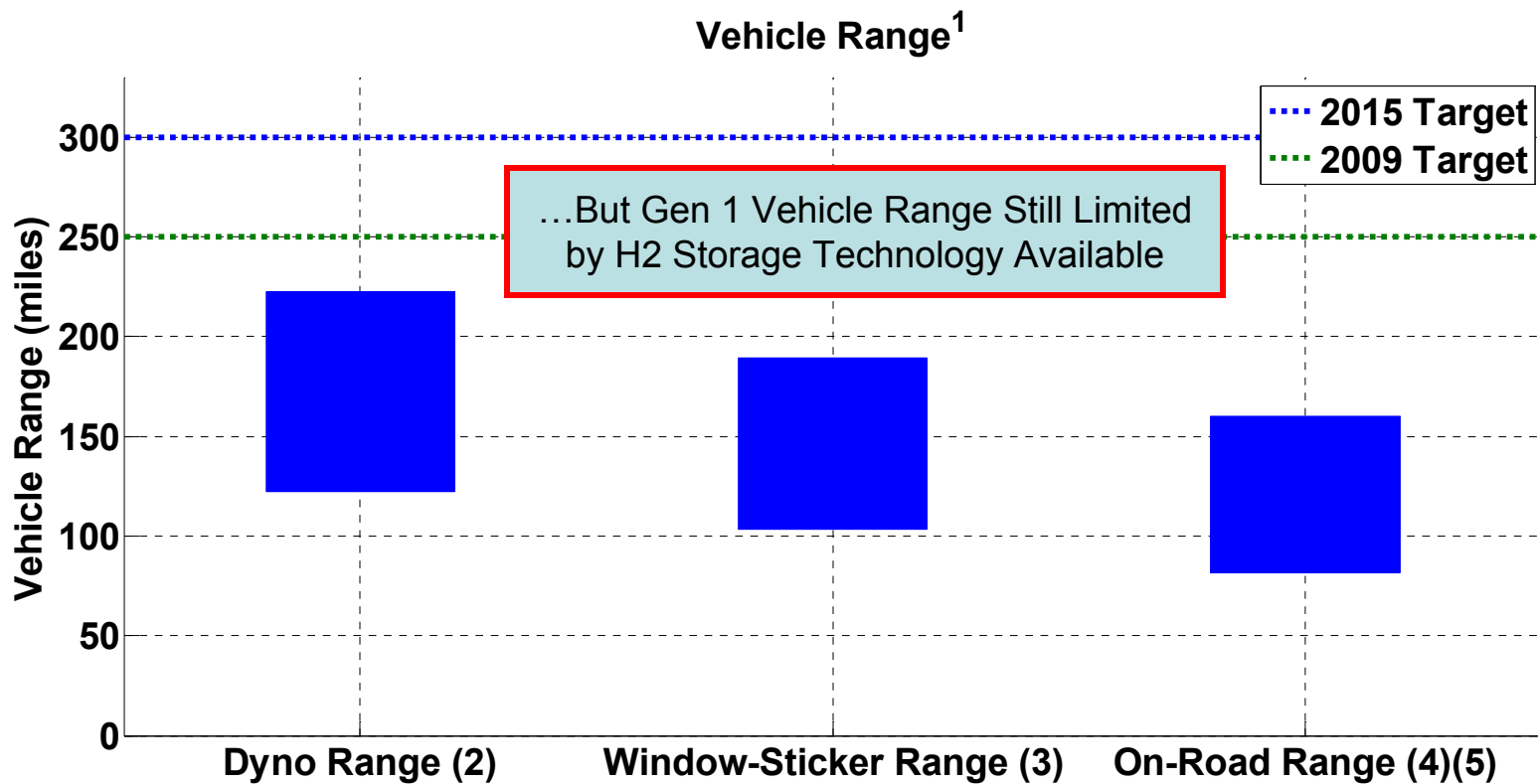

- (1) Range is based on fuel economy and usable hydrogen on-board the vehicle. One data point for each make/model.
- (2) Fuel economy from unadjusted combined City/Hwy per DRAFT SAE J2572.
- (3) Fuel economy from EPA Adjusted combined City/Hwy (0.78 x Hwy, 0.9 x City).
- (4) Excludes trips < 1 mile. One data point for on-road fleet average of each make/model.
- (5) Fuel economy calculated from on-road fuel cell stack current or mass flow readings.

Majority (75%) of Vehicles Travel <50% of Dyno Range Between Refuelings

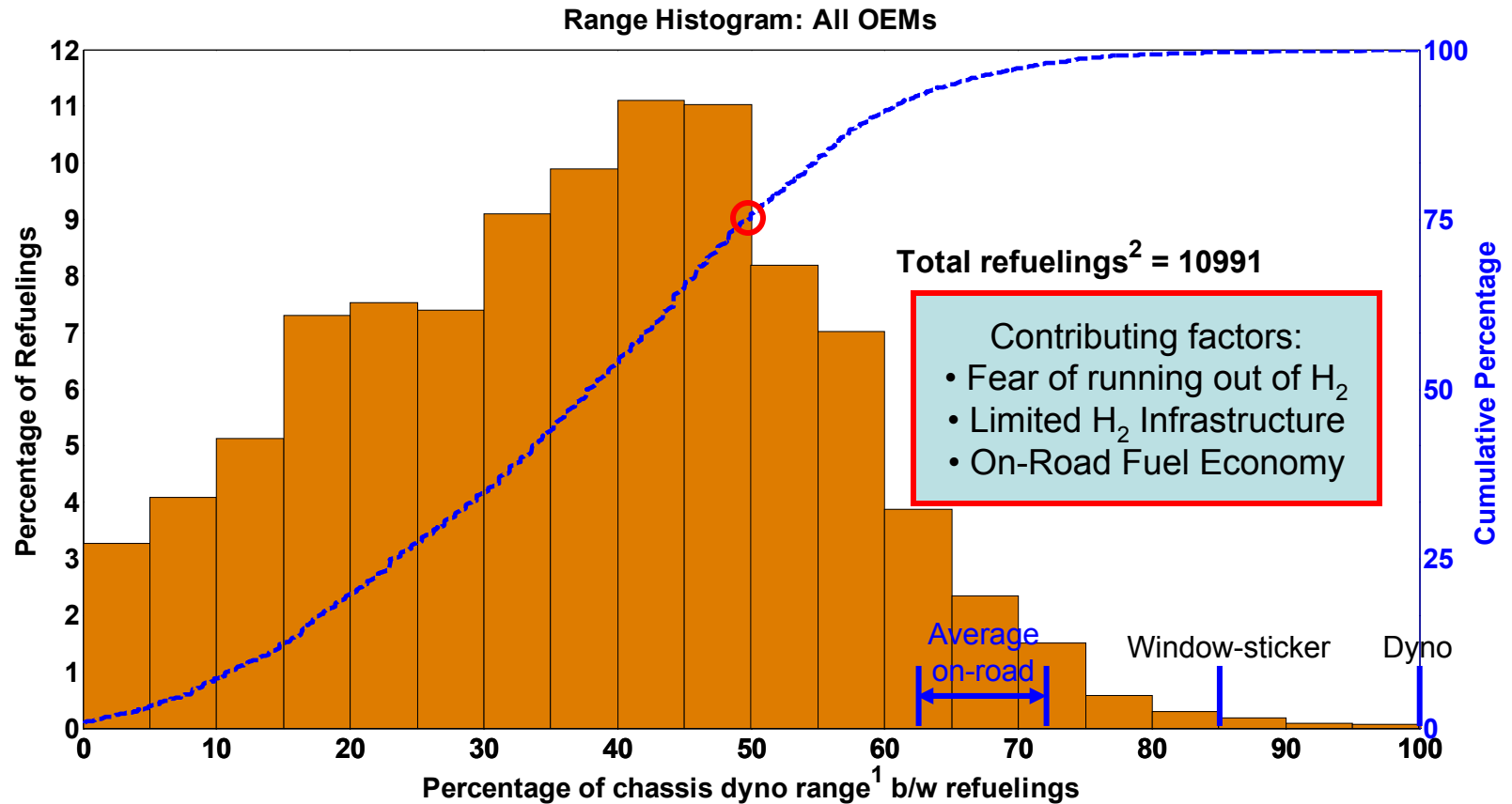

1. Range calculated using the combined City/Hwy fuel economy from dyno testing (not EPA adjusted) and usable fuel on board.

2. Some refueling events are not detected/reported due to data noise or incompleteness.

Created: Feb-15-08 9:20 AM

Large Spread in H2 Tank Level at Refueling Peak at ~1/4 Full, Median at ~3/8 Full

Tank Levels: DOE Fleet

Median Tank Level = 39% at Fill

Total refuelings¹ = 13085

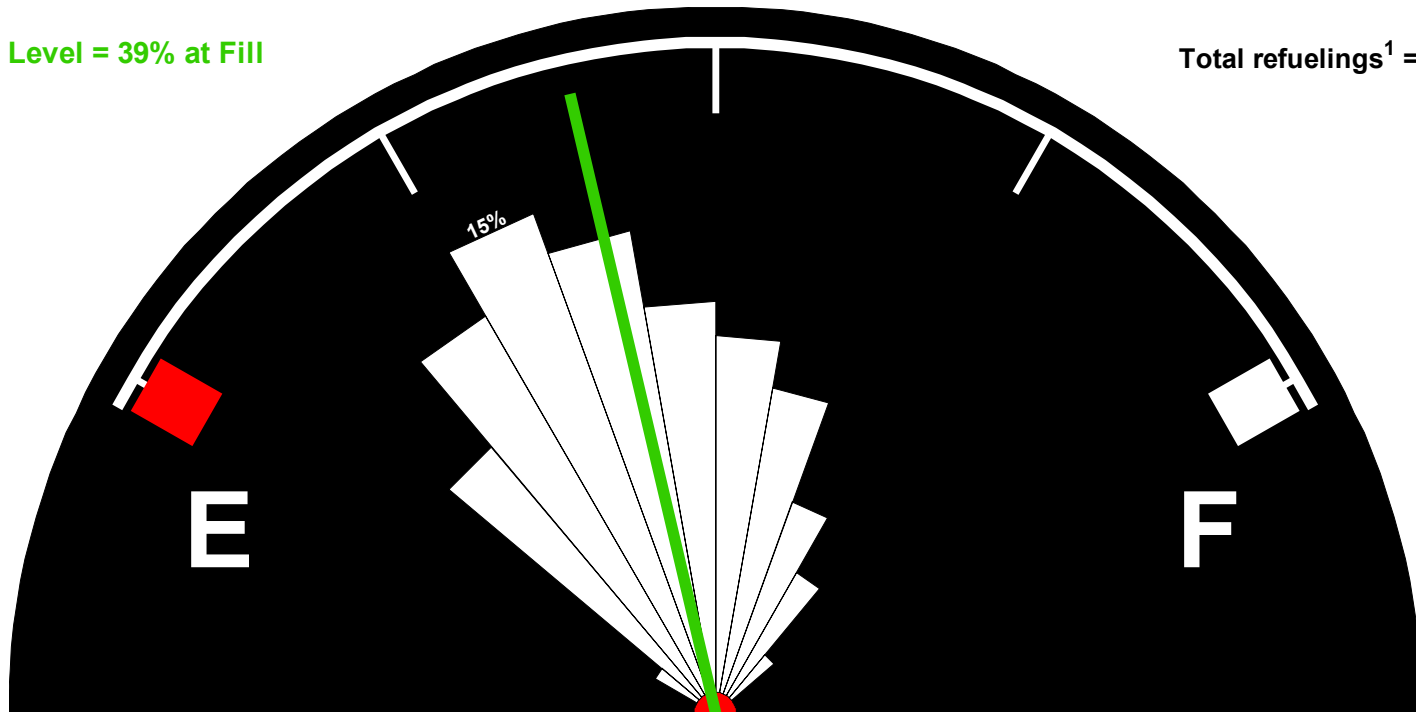

1. Some refueling events not recorded/detected due to data noise or incompleteness.
2. The outer arc is set at 20% total refuelings.
3. If tank level at fill was not available, a complete fill up was assumed.

Created: Feb-27-08 10:51 AM

700 bar On-Board H2 Storage Systems Demonstrate Potential for Improved Performance Over 350 bar

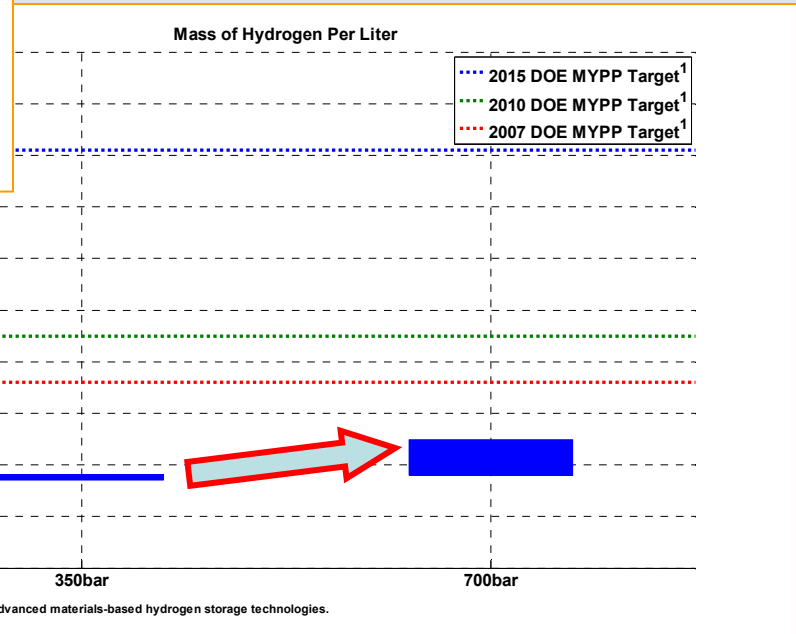
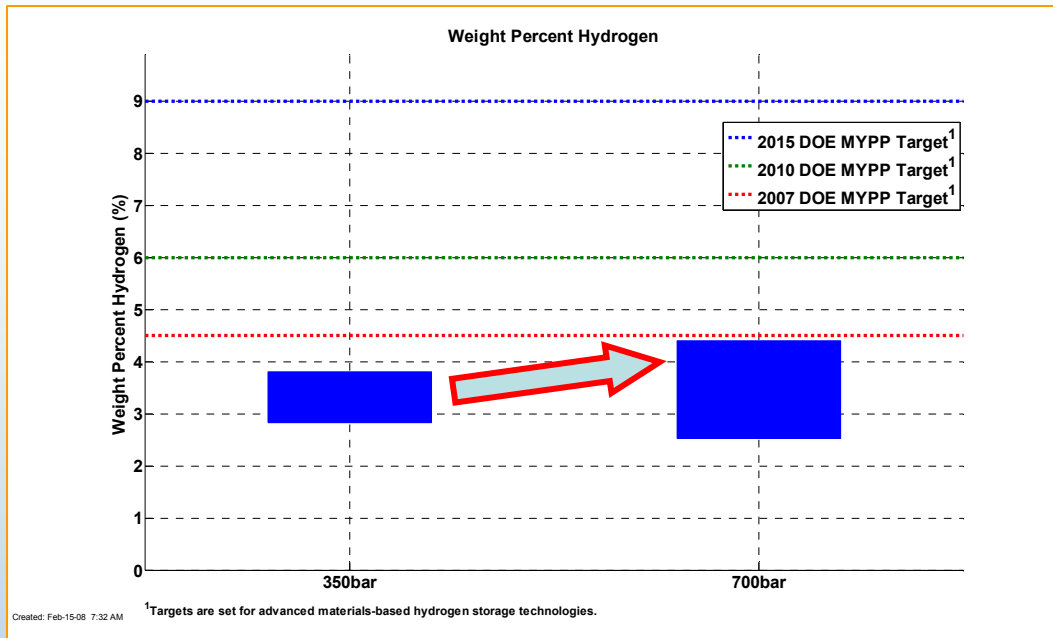

2nd Gen Vehicle Storage Data Collected; Allows a Comparison of 350 bar vs. 700 bar

More Detailed Data Reporting Allows a Comparison of Mass and Volume of H2, Pressure Vessel, and BOP

Average Breakout of H2 Storage System Mass

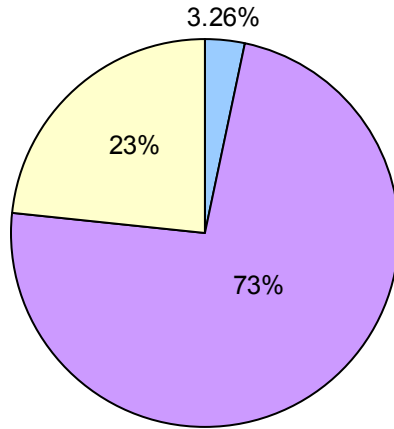

350 bar

Average Breakout of H2 Storage System Volume

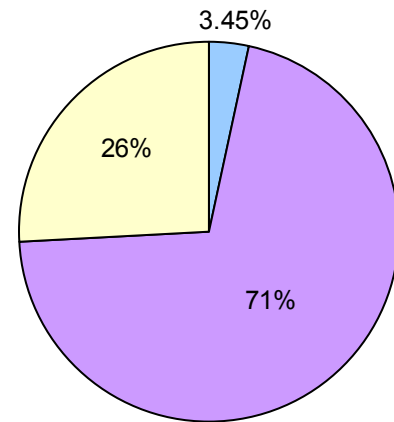
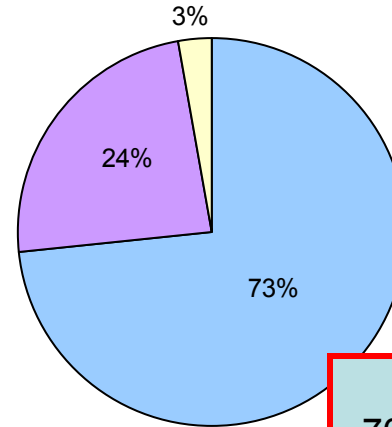

700 bar

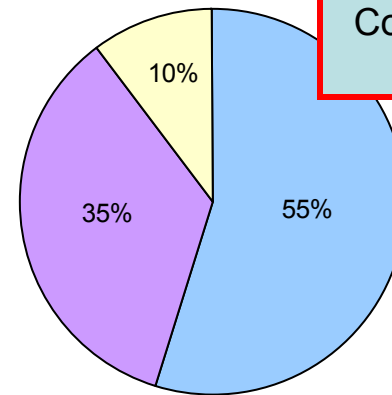

Pressure Vessel and BOP for 700 bar Systems Take Up Larger % of Volume, but Allow for a More Compact Package and Extended Range

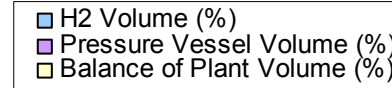
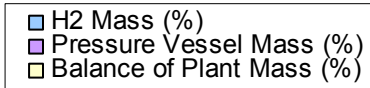

Created: Feb-15-08 6:53 AM

Approach: Method for Projecting Time to 10% Fuel Cell Stack Voltage Degradation (Linear Decay Fit, Calculated Voltage at t_0)

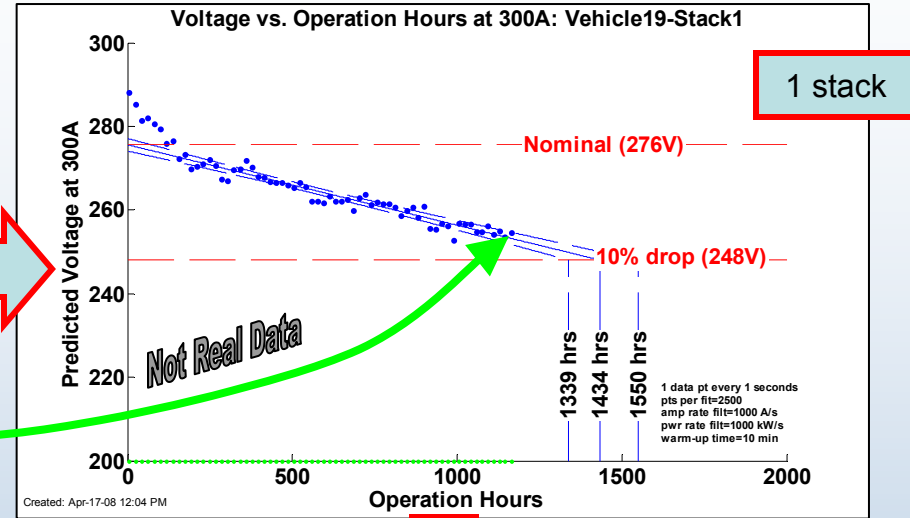
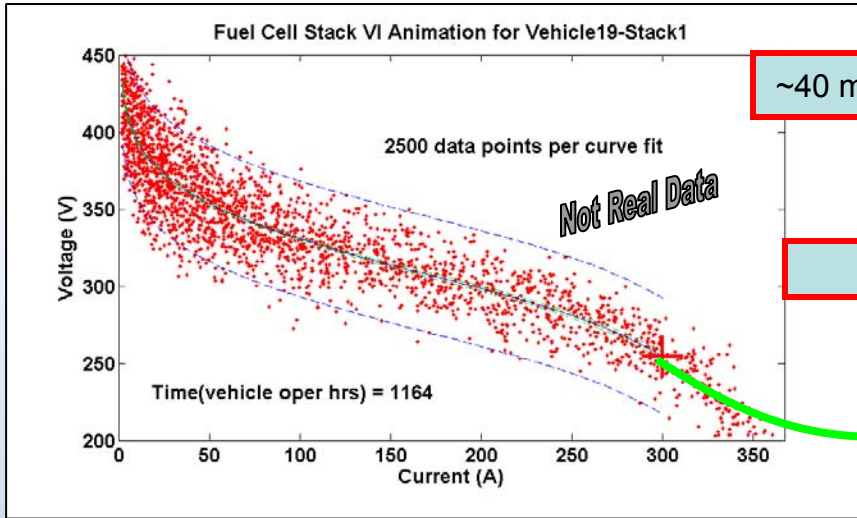

Note: 10% is an R&D metric for FC stack degradation. It does not necessarily indicate an end-of-life condition. OEMs may use other values or indicators.

Fixed t_0 voltages and non-linear decay fits will be investigated for Fall 2008 analysis of stacks with significant number of accumulated hours

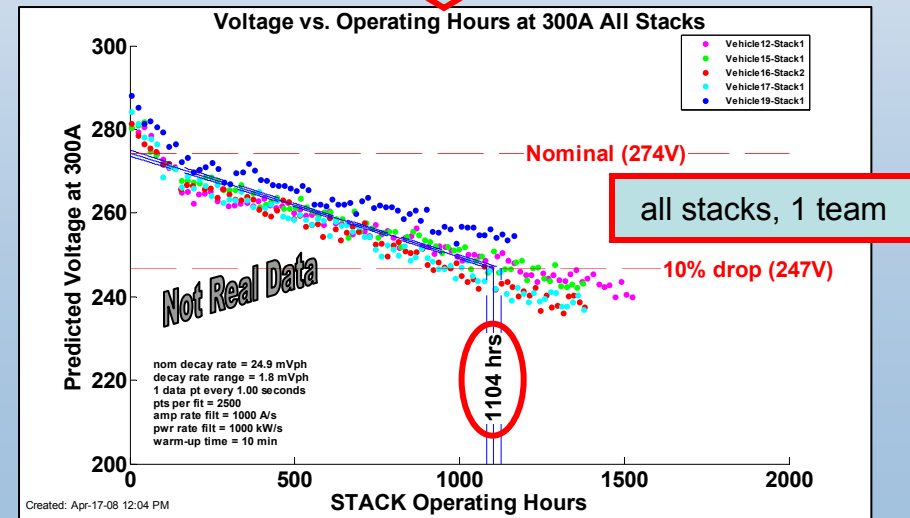

As More Gen 1 Data Is Accumulated, Some Teams Are Demonstrating Long FC Durability

DOE Learning Demonstration Fuel Cell Stack Durability:
Based on Data Through 2007 Q4

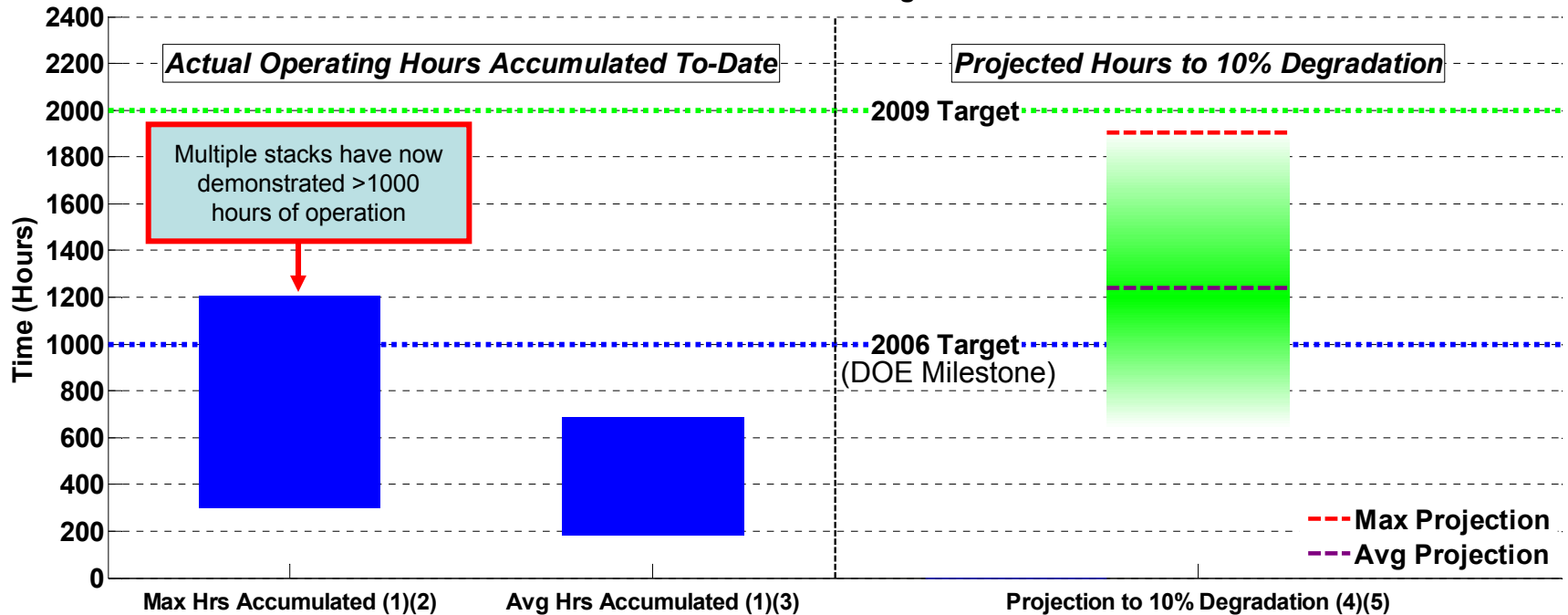

- (1) Range bars created using one data point for each OEM.
- (2) Range (highest and lowest) of the maximum operating hours accumulated to-date of any OEM's individual stack in "real-world" operation.
- (3) Range (highest and lowest) of the average operating hours accumulated to-date of all stacks in each OEM's fleet.
- (4) Projection using on-road data – degradation calculated at high stack current. This criterion is used for assessing progress against DOE targets, may differ from OEM's end-of-life criterion, and does not address "catastrophic" failure modes, such as membrane failure.
- (5) Using one nominal projection per OEM: "Max Projection" = highest nominal projection, "Avg Projection" = average nominal projection.
The shaded green bar represents an engineering judgment of the uncertainty due to data and methodology limitations. Projections will change as additional data are accumulated.

Approach: Use Multivariate Analysis to Determine Dominant Factors Affecting FC Degradation

The screenshot displays the EnCorrelate software interface, which is used for multivariate analysis. The interface is divided into several sections:

- Company:** EcoCars
- Vehicle:** H2 Coupe
- New Data Set Properties:** Min Stack Op Hrs: 100, DR Class Range: 15 to 70, Iteration: 1. Includes a list of stacks (Stack1 to Stack9) and variables (Op Hours, Starts #, Installs, BoLV, #ofTrips, Idlev1, Idlev2, Charge, %Time, 0-5% Power).
- Model Name:** EcoCars_MVdegModel
- Run PLS:** Options for using new or existing data set, adding classes and labels, and archiving previous analysis. A 'Create' button is present.
- PLS Details:** R²: 0.82, RMSEC: 0.43, RMSECV: 0.51. Explained Decay Rate Variance: LV1: 71.8%, LV2: 14.2%, LV3: 1.8%.
- Data Set Name:** EcoCars_MVdegData
- Data Figures:** A horizontal stacked bar chart titled 'EcoCars: % Time at Power Levels' showing the distribution of power levels for various stacks (Stack11, Stack1, Stack8, Stack3, Stack9, Stack7, Stack5, Stack10, Stack2, Stack6, Stack1). The legend indicates power levels: 0-5% (dark blue), 5-10% (blue), 10-20% (light blue), 20-40% (cyan), 40-60% (green), 60-80% (yellow-green), 80-100% (yellow), and >100% (red).
- PLS Figures:** A 'Fake Data BiPlot: with Labels' showing the relationship between LV1 and LV2. The plot includes data points for various stacks and variables, with a legend for 'LV 2 (33.07%)' categories: Age DR, H2 DR, Low DR, Variable loading, H2E DR, and Variable DR.
- PLS Figure Selections:** A dropdown menu for 'LV2 vs LV1 BiPlot' with 'Browse', 'Open fig', and 'Open emf' buttons.
- Data Figure Selections:** A dropdown menu for 'EcoCars Power Bins' with 'Browse', 'Open fig', and 'Open emf' buttons.

At the bottom of the interface, there are four main action buttons: CRUNCH, THINK, CORRELATE, and PUBLISH. A large, bold, black text overlay on the right side of the plot area reads "Not Real Data".

Primary Factors Affecting Learning Demo Fleet Fuel Cell Degradation: FC Diversity (Between Teams) Limits Drawing Strong Conclusions

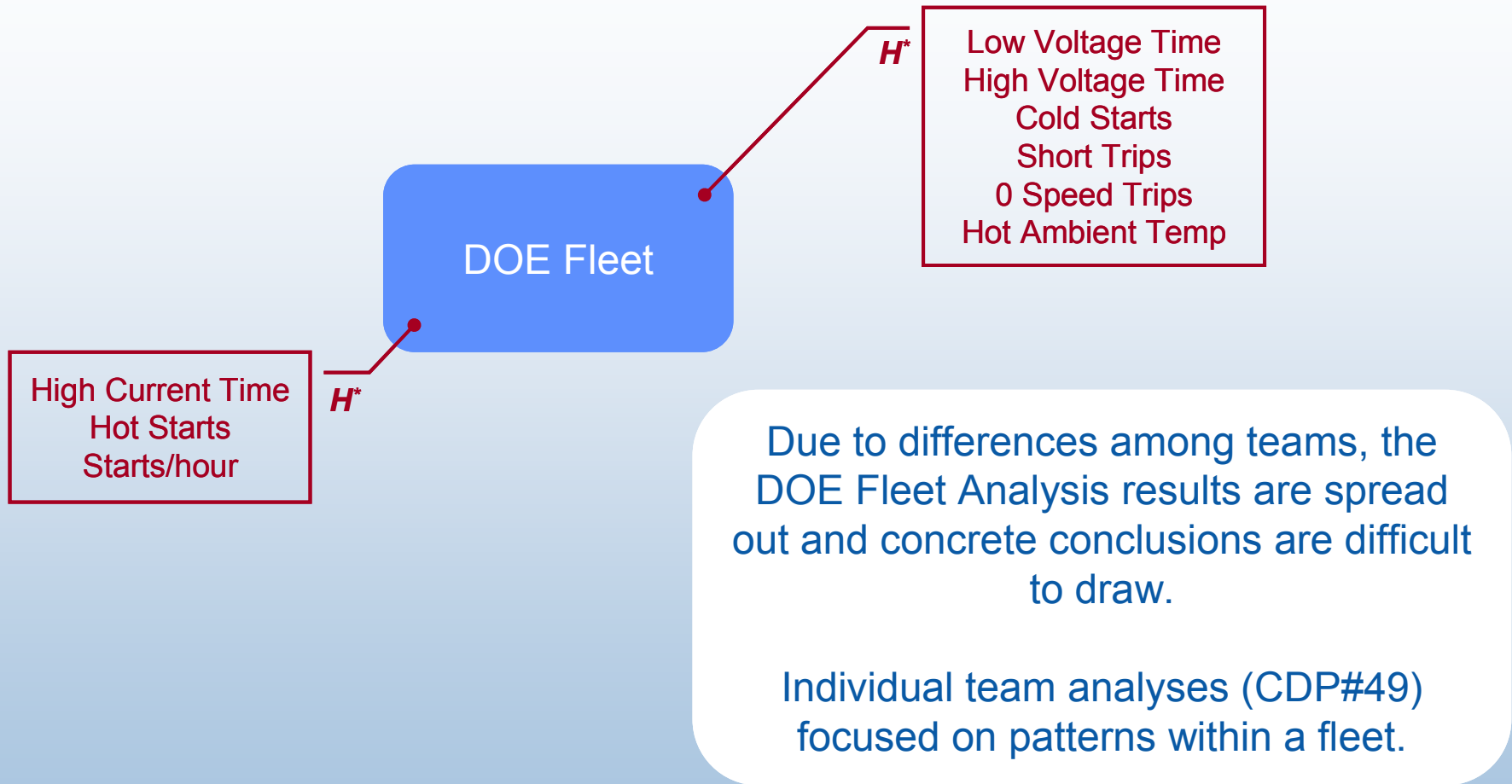

- 1) On-going fuel cell degradation study using Partial Least Squares (PLS) regression model for combined Learning Demonstration Fleet.
- 2) DOE Fleet model has a low percentage of explained decay rate variance.

H*: Factor group associated with high decay rate fuel cell stacks
L**: Factor group associated with low decay rate fuel cell stacks

Primary Factors Affecting Fuel Cell Degradation are Hard to Extract, and Different (sometimes opposite) for Each Team

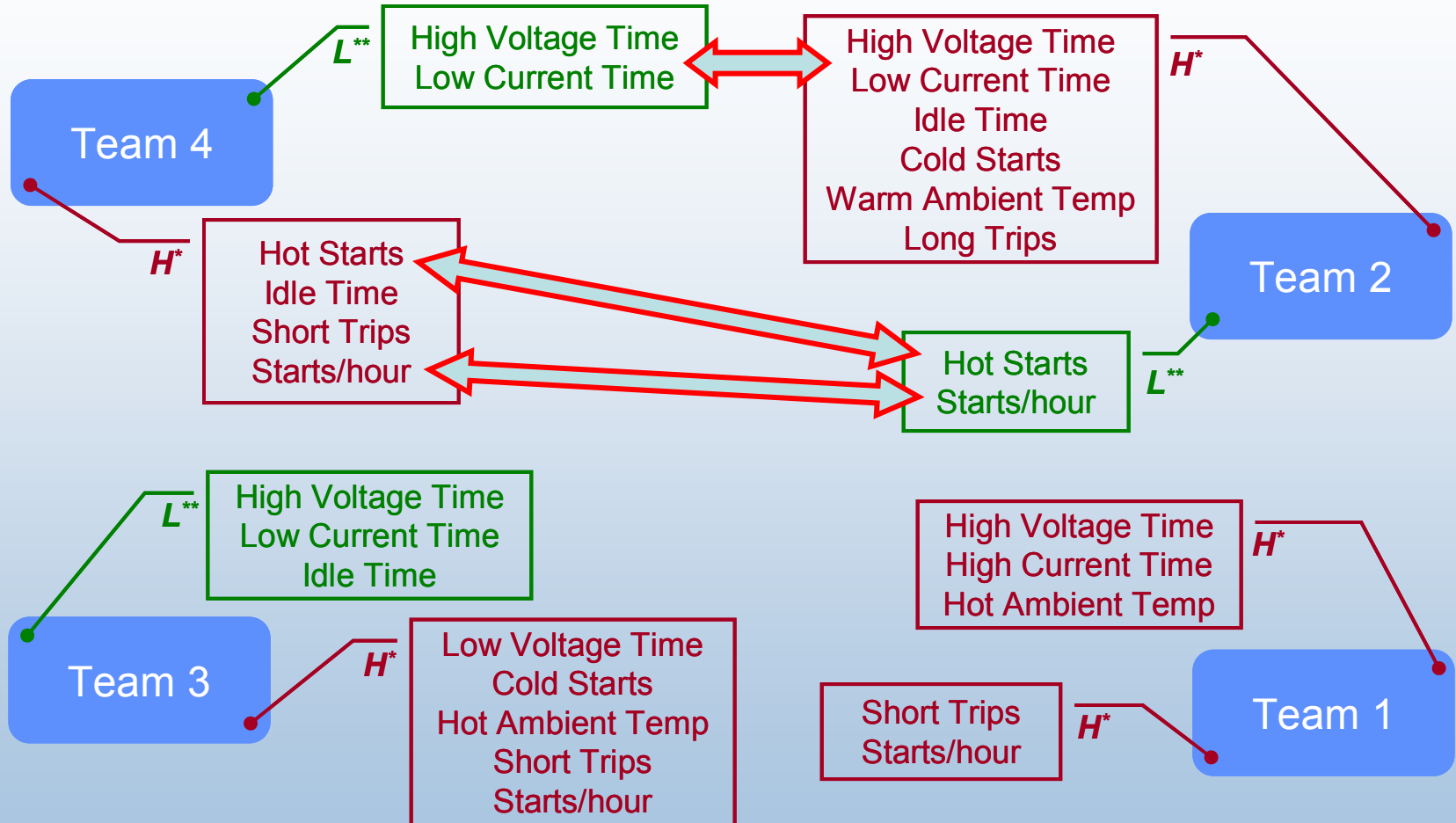

- 1) On-going fuel cell degradation study using Partial Least Squares (PLS) regression model for each team.
- 2) Teams' PLS models have a high percentage of explained decay rate variance, but the models are not robust and results are scattered.

H^* : Factor group associated with high decay rate fuel cell stacks
 L^{**} : Factor group associated with low decay rate fuel cell stacks

Large Number of Short Trips Contribute to a Lower Daily Distance than National Average

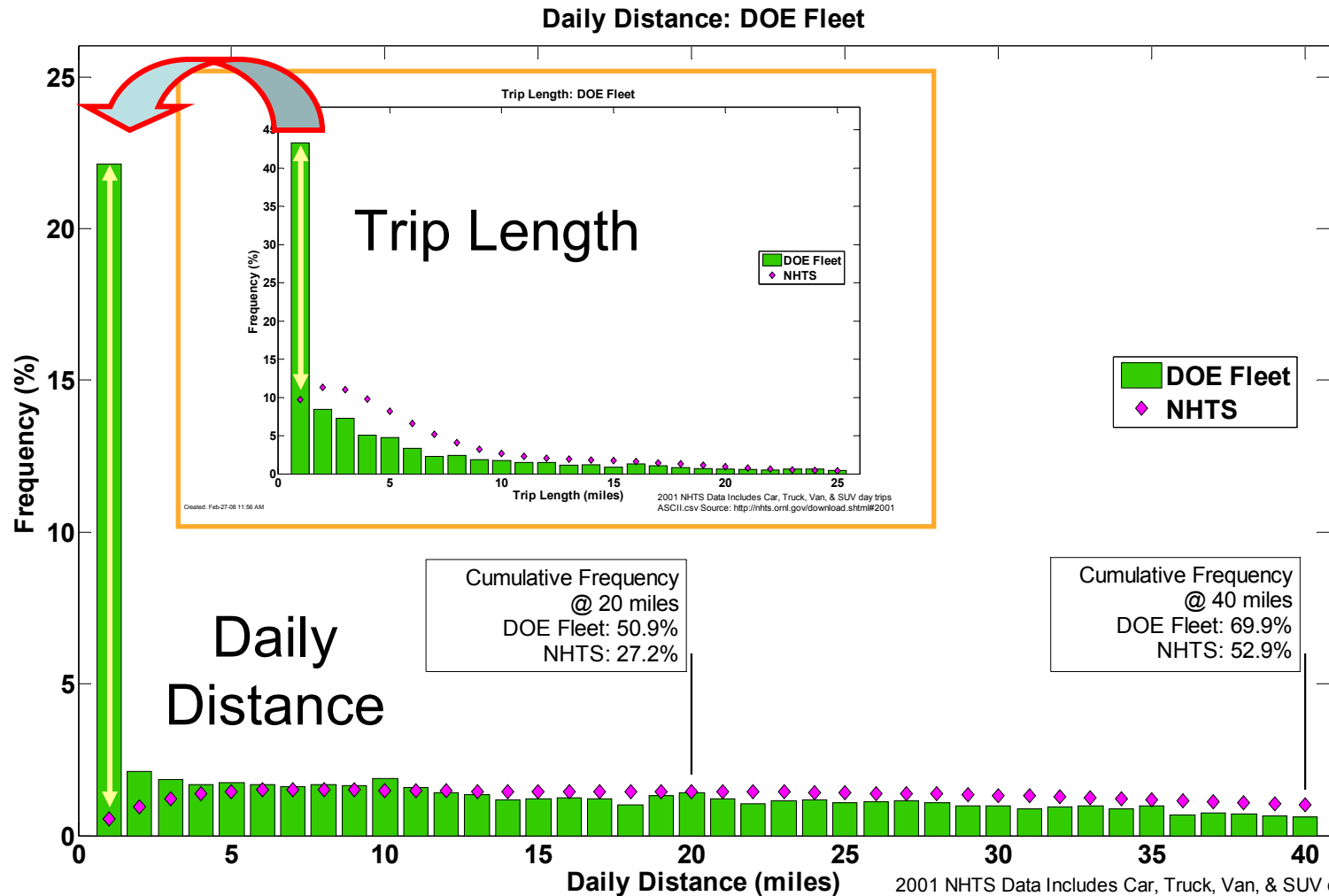

Created: Feb-27-08 11:56 AM

2001 NHTS Data Includes Car, Truck, Van, & SUV day trips
ASCII.csv Source: <http://nhts.orl.gov/download.shtml#2001>

Examining Time Between Trips Shows Fuel Cells Experiencing Large # Hot Starts

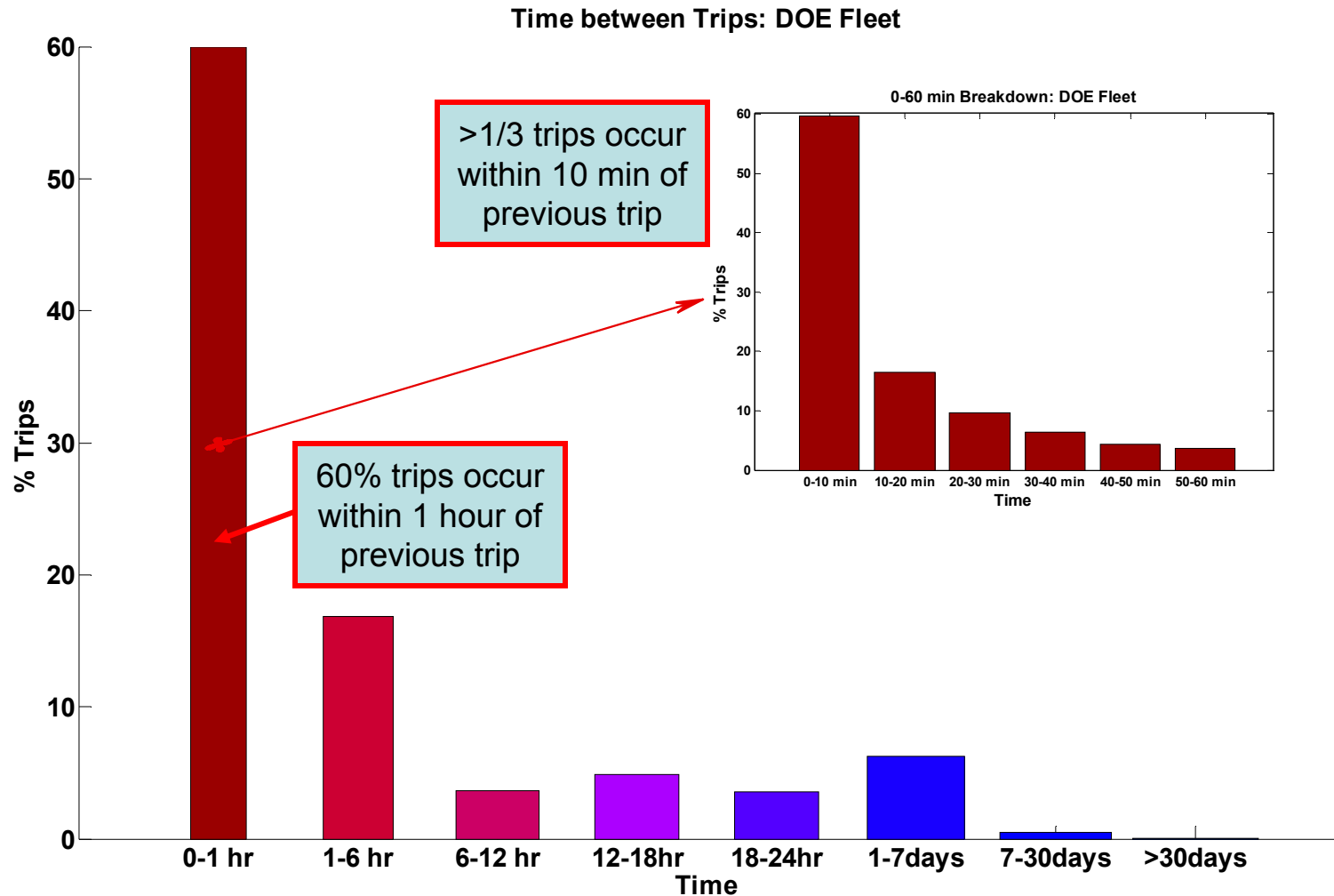

Created: Feb-27-08 11:56 AM

While Most of FC Time is Spent at Idle, Bulk of Energy is at 20-50% Power

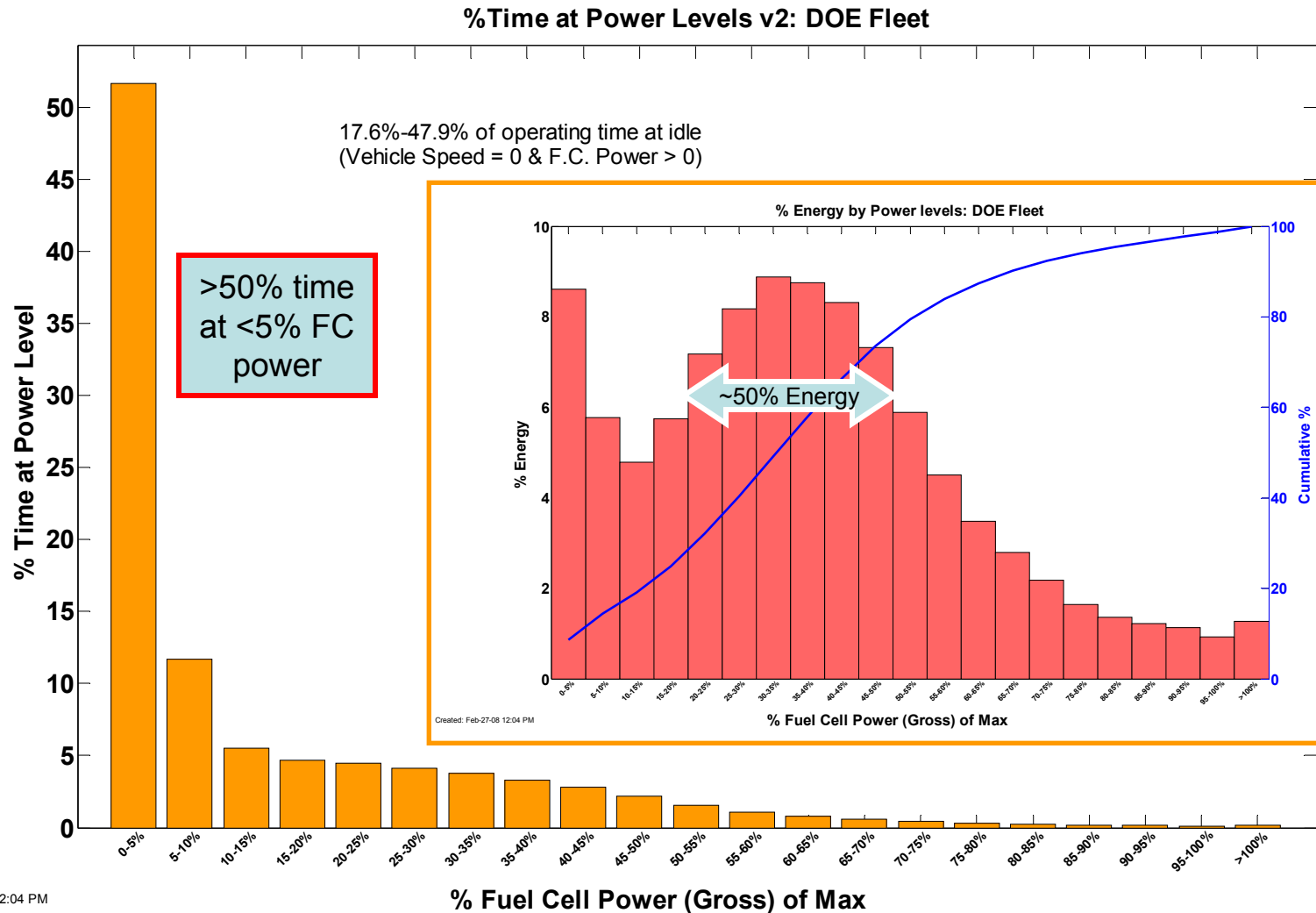

Created: Feb-27-08 12:04 PM

Gen 1 Baseline Dyno Tests Validated High Efficiency at 1/4 Power Point – Gen 2 Tests to Occur in 2008

Fuel Cell System¹ Efficiency² at ~25% Net Power.

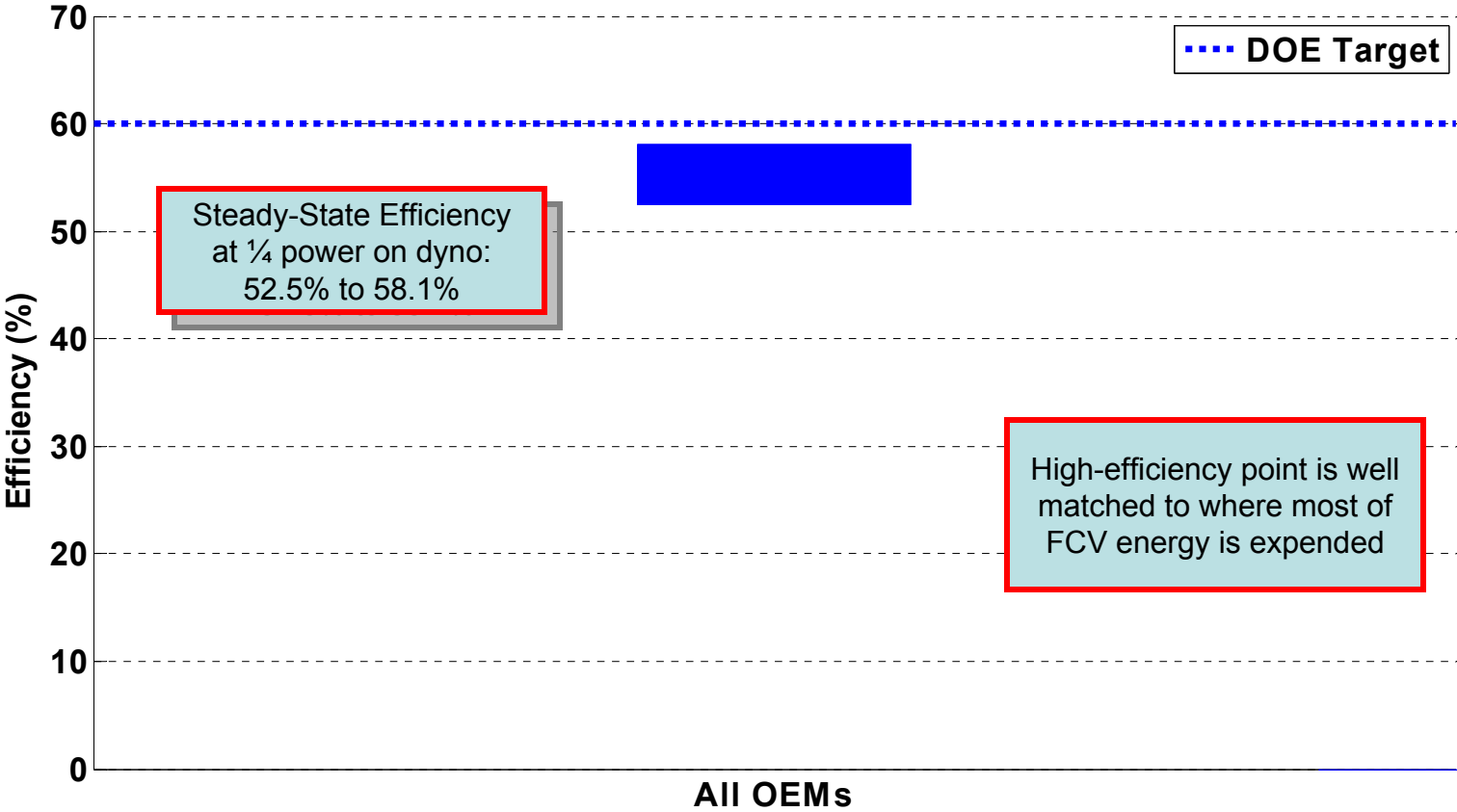

¹ Gross stack power minus fuel cell system auxiliaries, per DRAFT SAEJ2615.

² Ratio of DC output energy to the lower heating value of the input fuel (hydrogen). Excludes power electronics and electric drive.

~40% of Learning Demo Trips Require <0.5 kWh of Fuel Cell Output Energy

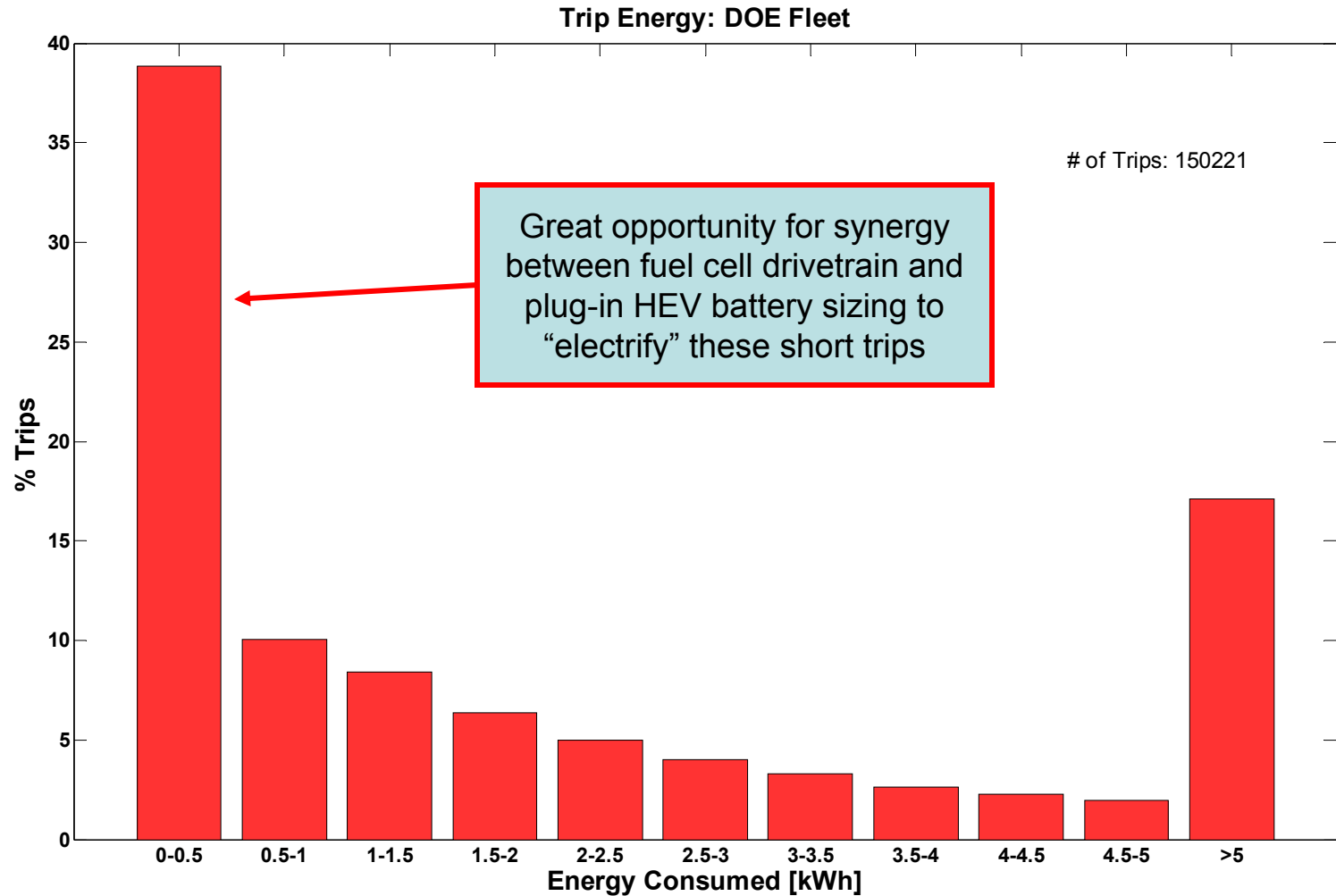

Created: Feb-27-08 12:04 PM

Minimal Vehicle Safety Reports Continue to Demonstrate a Strong Safety Record

Safety Reports - Vehicle Operation

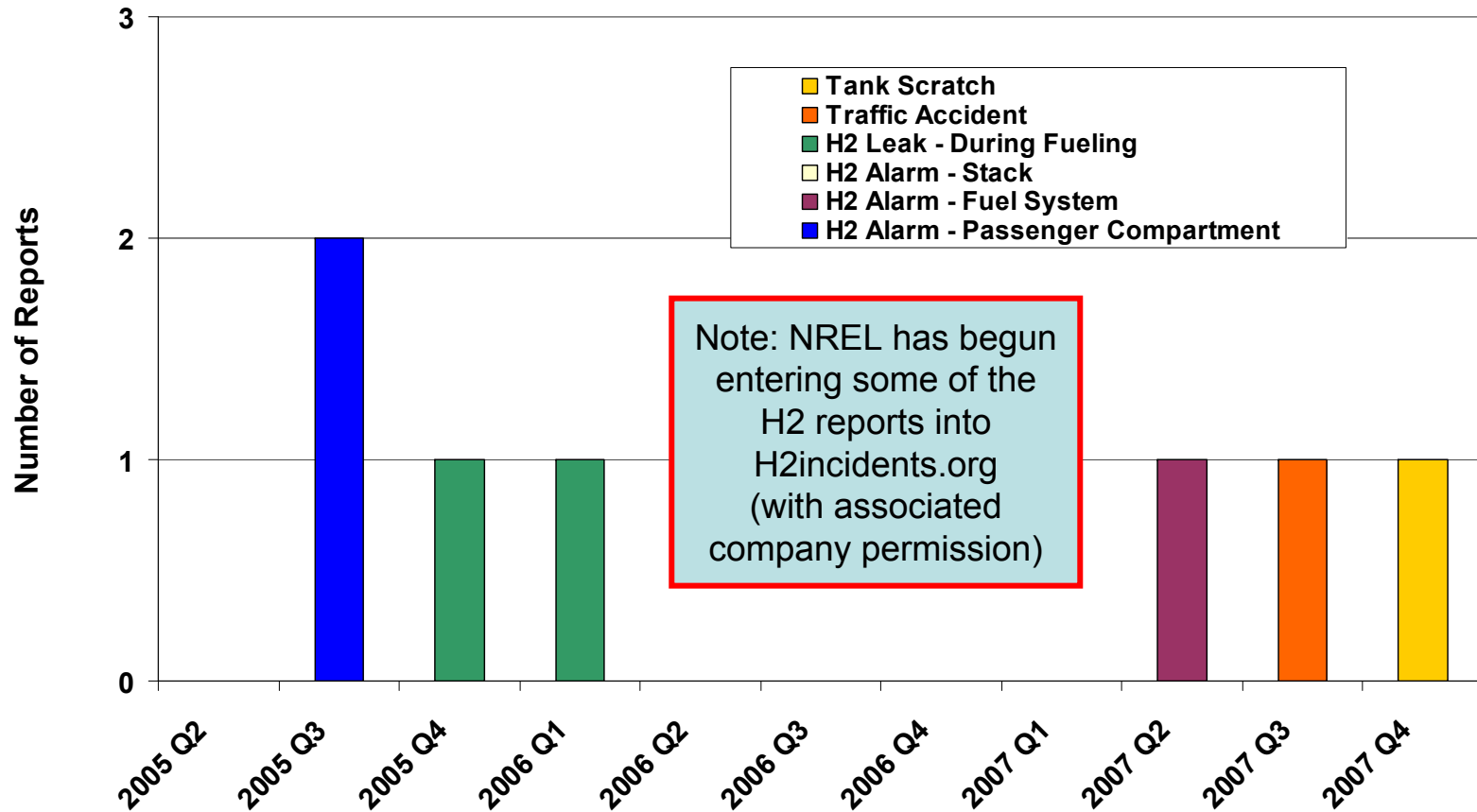

Created: 2/15/08 9:00 AM

Most of Infrastructure Safety Reports Continue to Be Non-Events (and Most of Those, Alarms Only)

Total Infrastructure Safety Reports by Severity and Report Type Through 2007 Q4

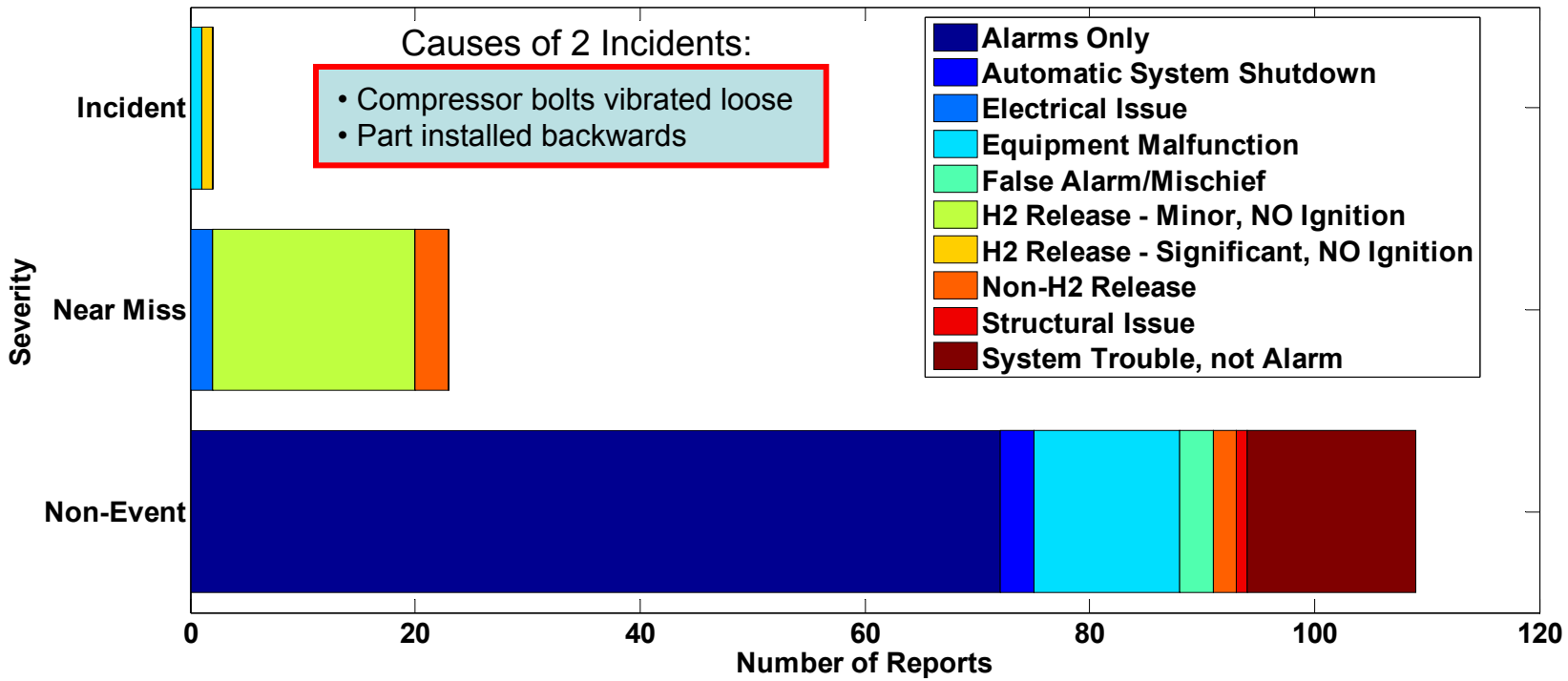

Causes of 2 Incidents:

- Compressor bolts vibrated loose
- Part installed backwards

- An INCIDENT is an event that results in:
- a lost time accident and/or injury to personnel
 - damage/unplanned downtime for project equipment, facilities or property
 - impact to the public or environment
 - any hydrogen release that unintentionally ignites or is sufficient to sustain a flame if ignited
 - release of any volatile, hydrogen containing compound (other than the hydrocarbons used as common fuels)
- A NEAR-MISS is:
- an event that under slightly different circumstances could have become an incident
 - unplanned H2 release insufficient to sustain a flame

Created: Feb-15-08 1:24 PM

Overall Infrastructure Safety Reports Correlated with Increase in New Stations Coming Online

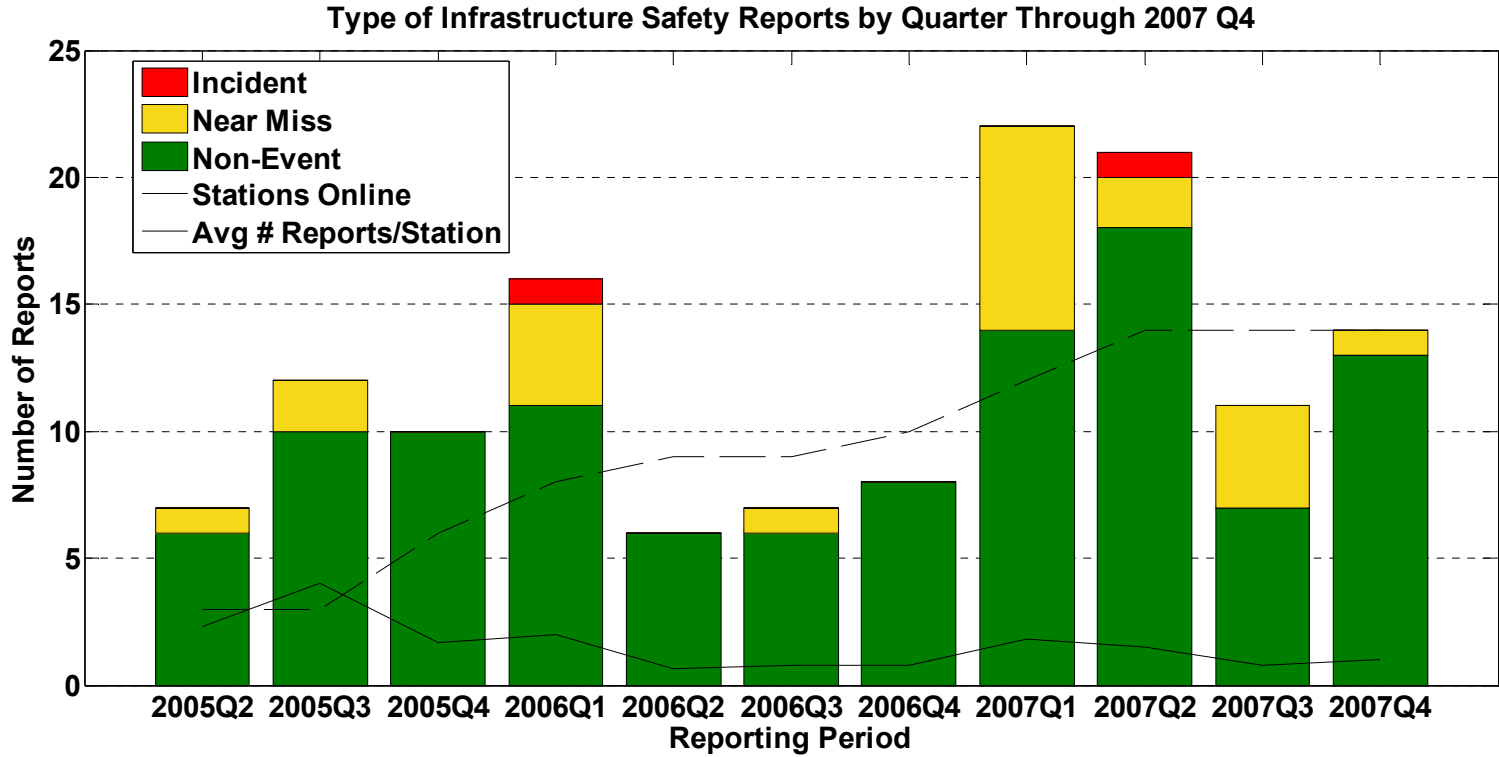

- An INCIDENT is an event that results in:
- a lost time accident and/or injury to personnel
 - damage/unplanned downtime for project equipment, facilities or property
 - impact to the public or environment
 - any hydrogen release that unintentionally ignites or is sufficient to sustain a flame if ignited
 - release of any volatile, hydrogen containing compound (other than the hydrocarbons used as common fuels)
- A NEAR-MISS is:
- an event that under slightly different circumstances could have become an incident
 - unplanned H2 release insufficient to sustain a flame

Created: Feb-15-08 1:24 PM

Hydrogen Impurities Sampled from All Stations to Date

In General, Inert Gases and Sulfur Have Had High Detection Limits

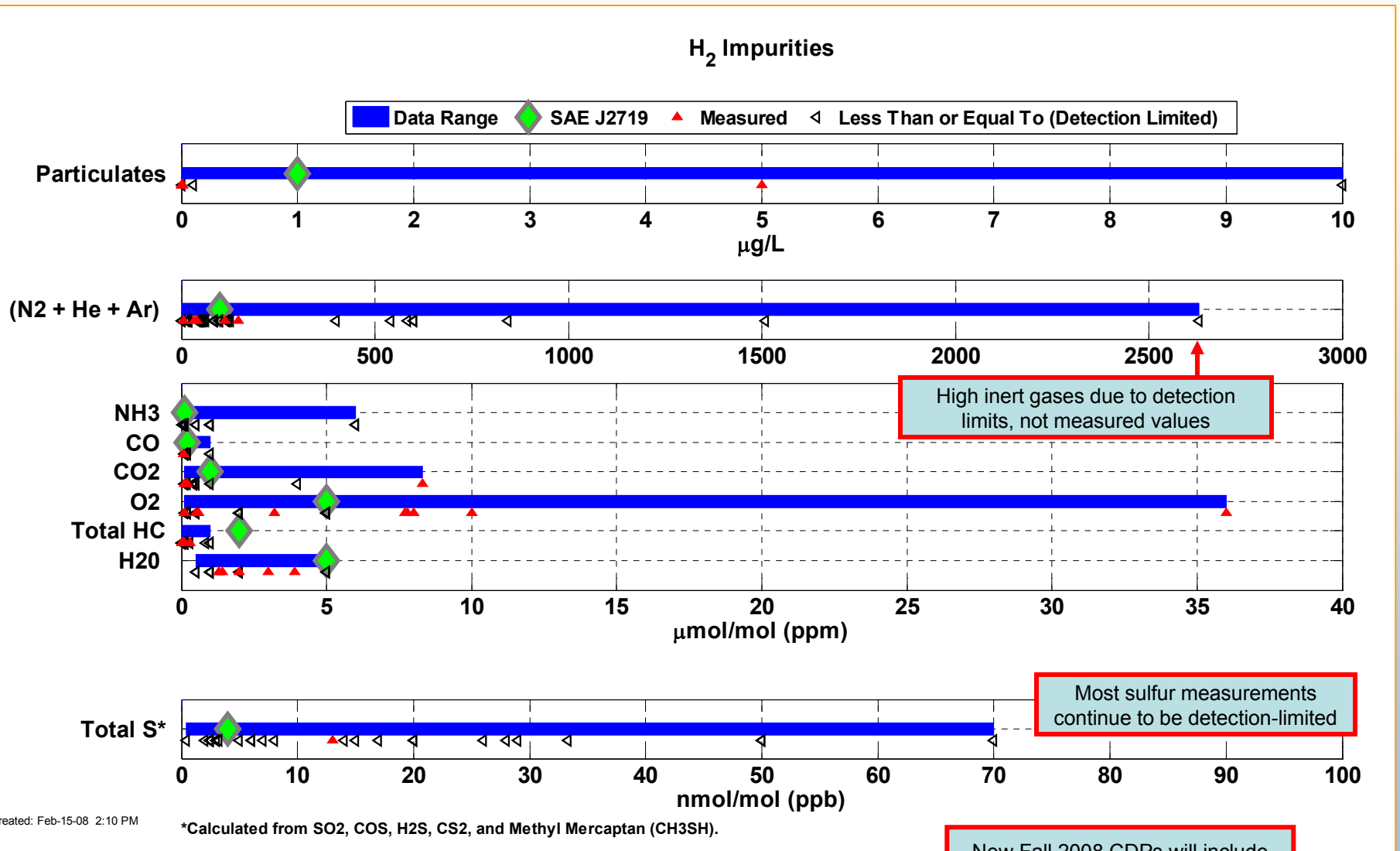

Created: Feb-15-08 2:10 PM

New Fall 2008 CDPs will include impurities by production technology and time

Actual Vehicle Refueling Times and Amounts from 8,700 Events: Measured by Stations or by Vehicles

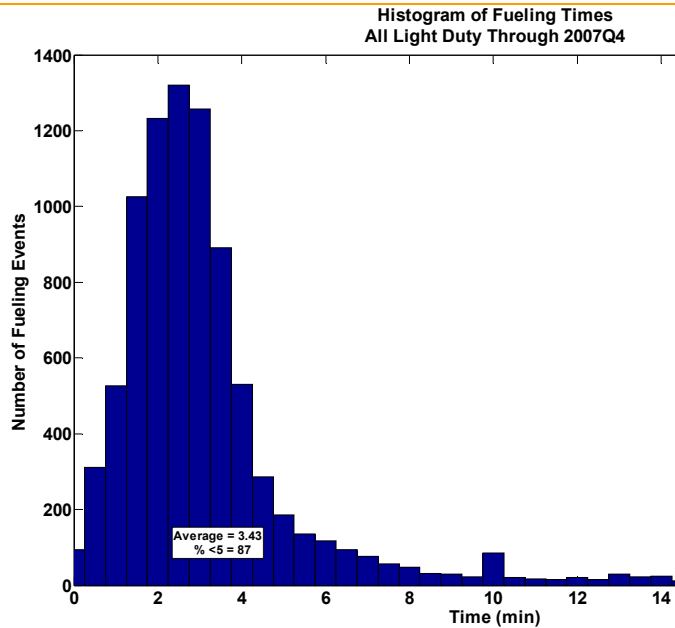

Average time: 3.43 min
87% of refueling events took <5 min

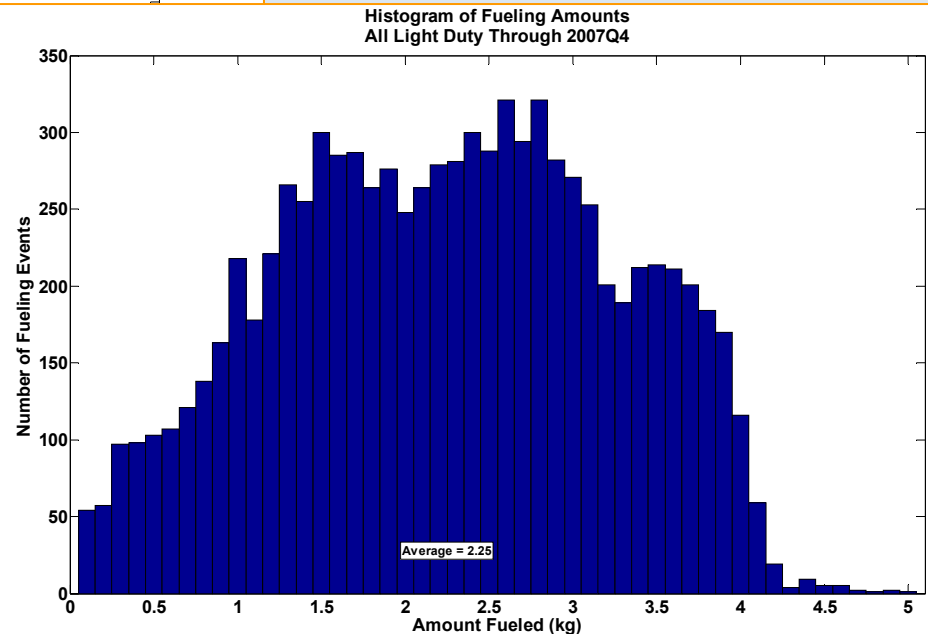

Average fill amount: 2.25 kg

Includes Communication and Non-Communication Fills

Actual Vehicle Refueling Rates from >8,700 Events: Measured by Stations or by Vehicles

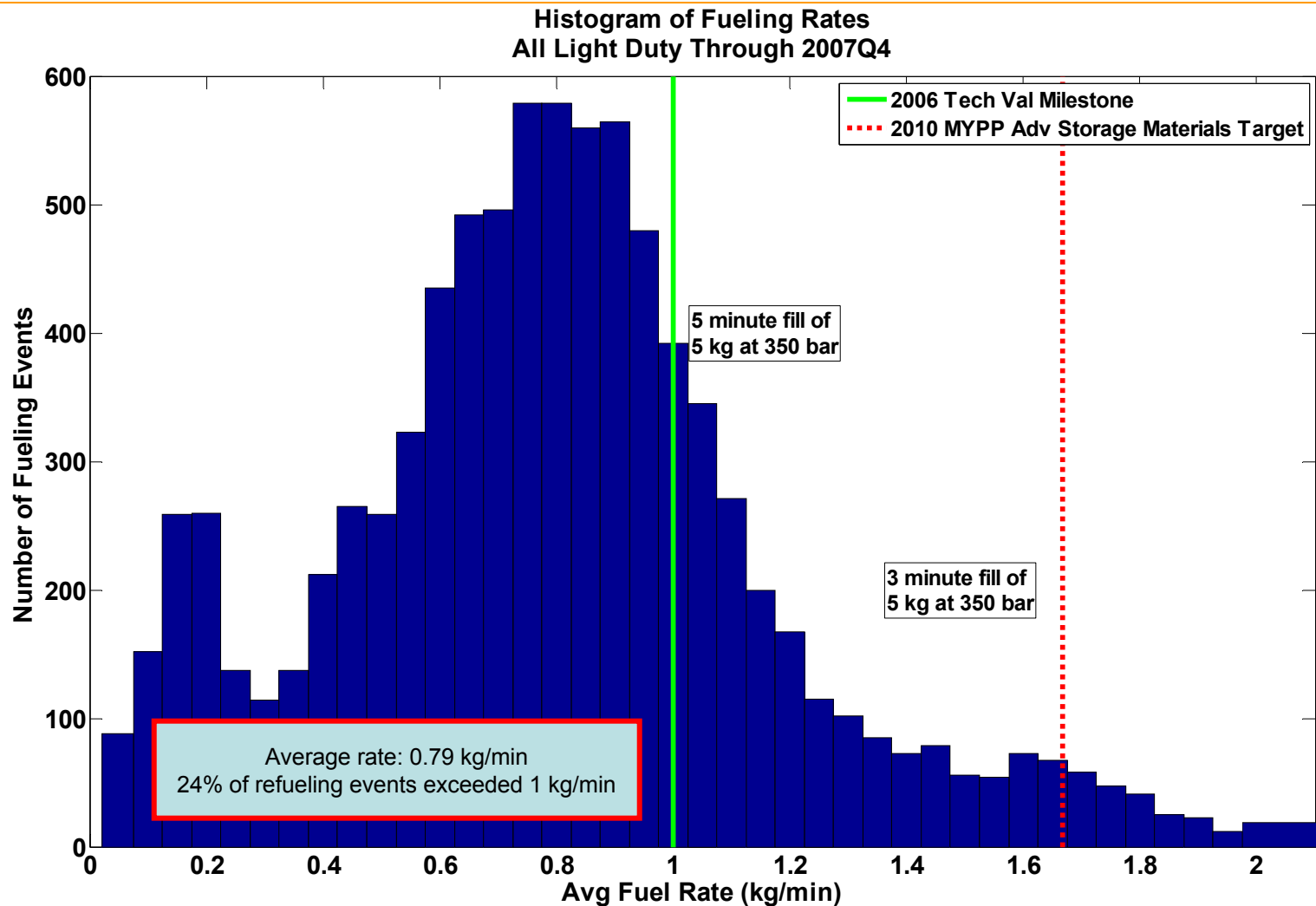

Created: Feb-15-08 1:44 PM

Includes Communication and Non-Communication Fills

Communication H2 Fills Achieving Higher Fill Rate than Non-Communication

Histogram of Fueling Rates
Comm vs Non-Comm Fills - All Light Duty Through 2007Q4

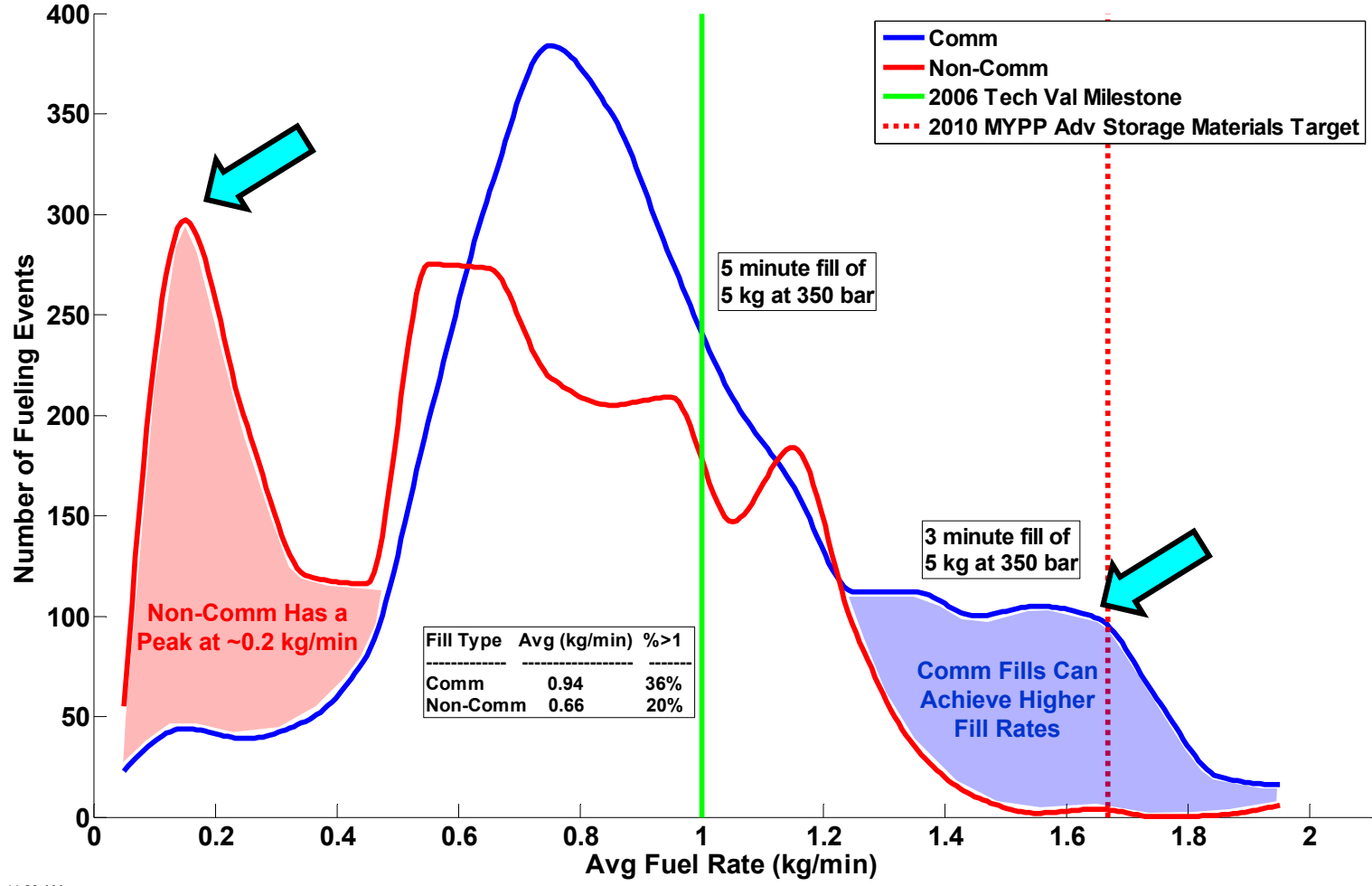

Created: Feb-27-08 11:26 AM

Examining Refueling Data by Year Shows 0.2 kg/min Rate Phased Out

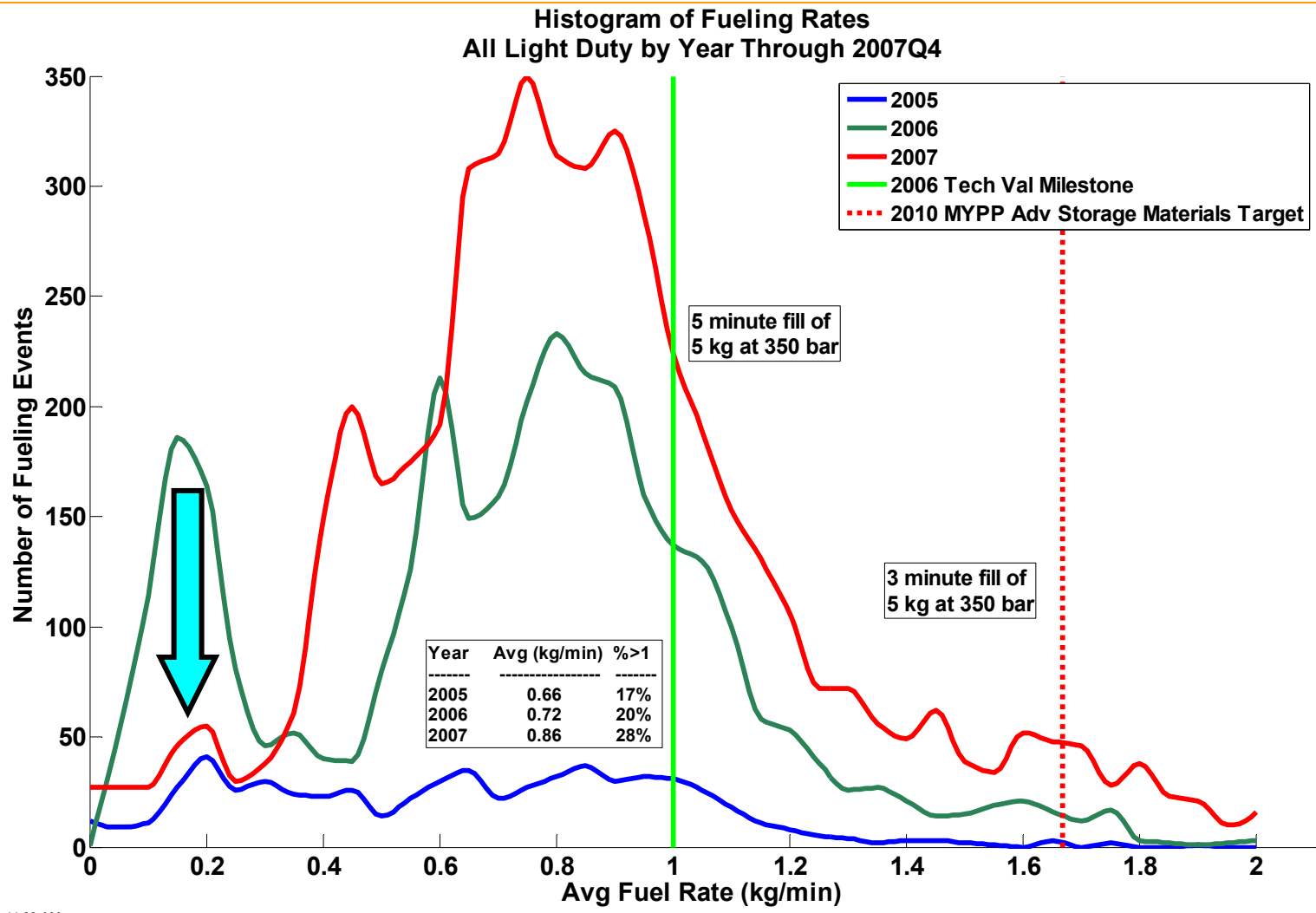

Created: Feb-27-08 11:39 AM

Includes Communication and Non-Communication Fills

Refueling by Time of Day; Relatively Uniform Refueling Infrastructure Demand Between 8-4

Refueling by Time of Day: DOE Fleet

% of fills b/t 6 AM & 6 PM: 86.5%

Total Fill³ Events = 11356

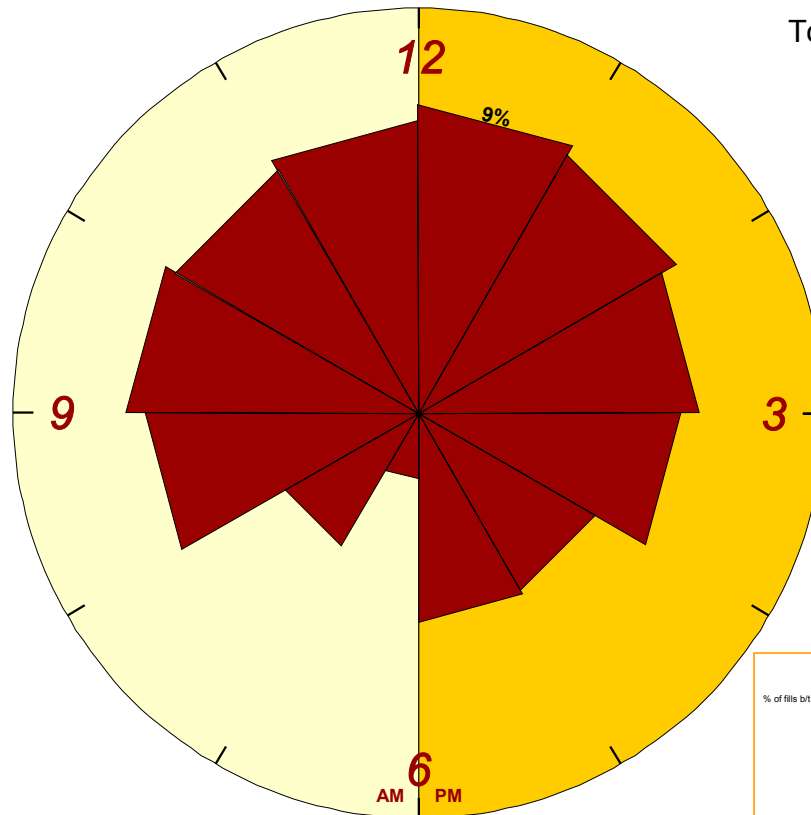

1. Fills between 6 AM & 6 PM
2. The outer arc is set at 12 % total Fill.
3. Some events not recorded/detected due to data noise or incompleteness.

Created: Feb-27-08 10:51 AM

Night

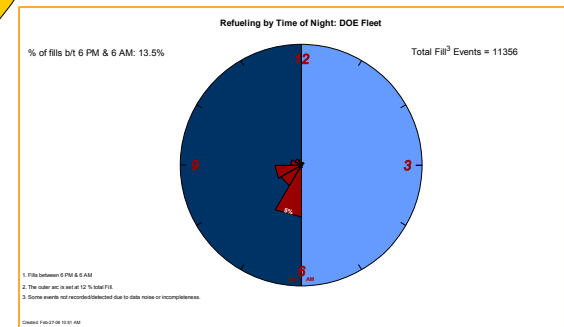

1. Fills between 6 PM & 6 AM
2. The outer arc is set at 12 % total Fill.
3. Some events not recorded/detected due to data noise or incompleteness.

Created: Feb-27-08 10:51 AM

Driving Trip Start Time – Day; Roughly Matches National Statistics Except for 5-6 PM

Driving Start Time - Day: DOE Fleet

% of driving trips b/t 6 AM & 6 PM: 88.7%

% of NHTS trips b/t 6 AM & 6 PM: 81.5%

Total Driving³ Events = 139968

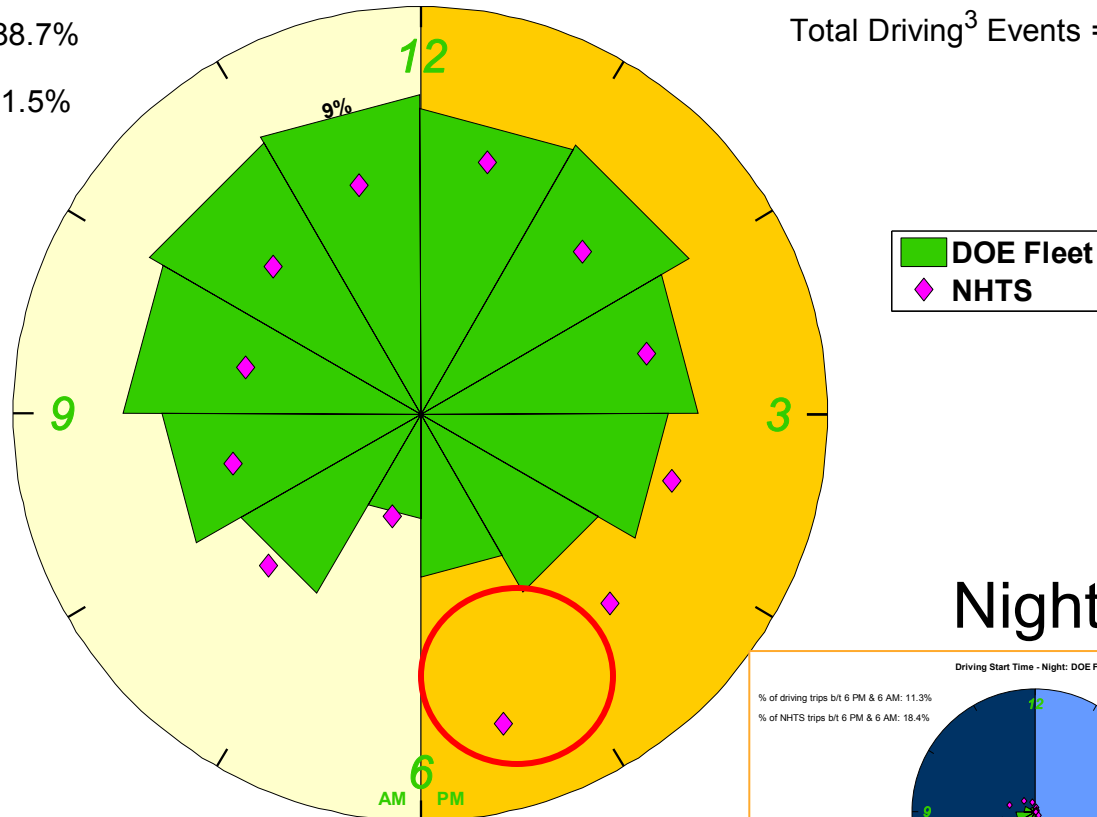

Night

Driving Start Time - Night: DOE Fleet

% of driving trips b/t 6 PM & 6 AM: 11.3%

% of NHTS trips b/t 6 PM & 6 AM: 18.4%

Total Driving³ Events = 139968

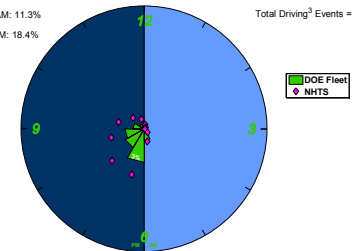

1. Driving trips between 6 AM & 6 PM
2. The outer arc is set at 12 % total Driving.
3. Some events not recorded/detected due to data noise or incompleteness.

Created: Feb-27-08 10:51 AM

1. Driving trips between 6 PM & 6 AM
 2. The outer arc is set at 12 % total Driving
 3. Some events not recorded/detected due to data noise or incompleteness.

2001 NHTS Data Includes Car, Truck, Van, & SUV only from
 ASCI Data Source: <http://hds.ornl.gov/download/show/2001>

Gen 1 Learning Demo FCV Travel Has Been Primarily Weekday Driving; Differs from NHTS

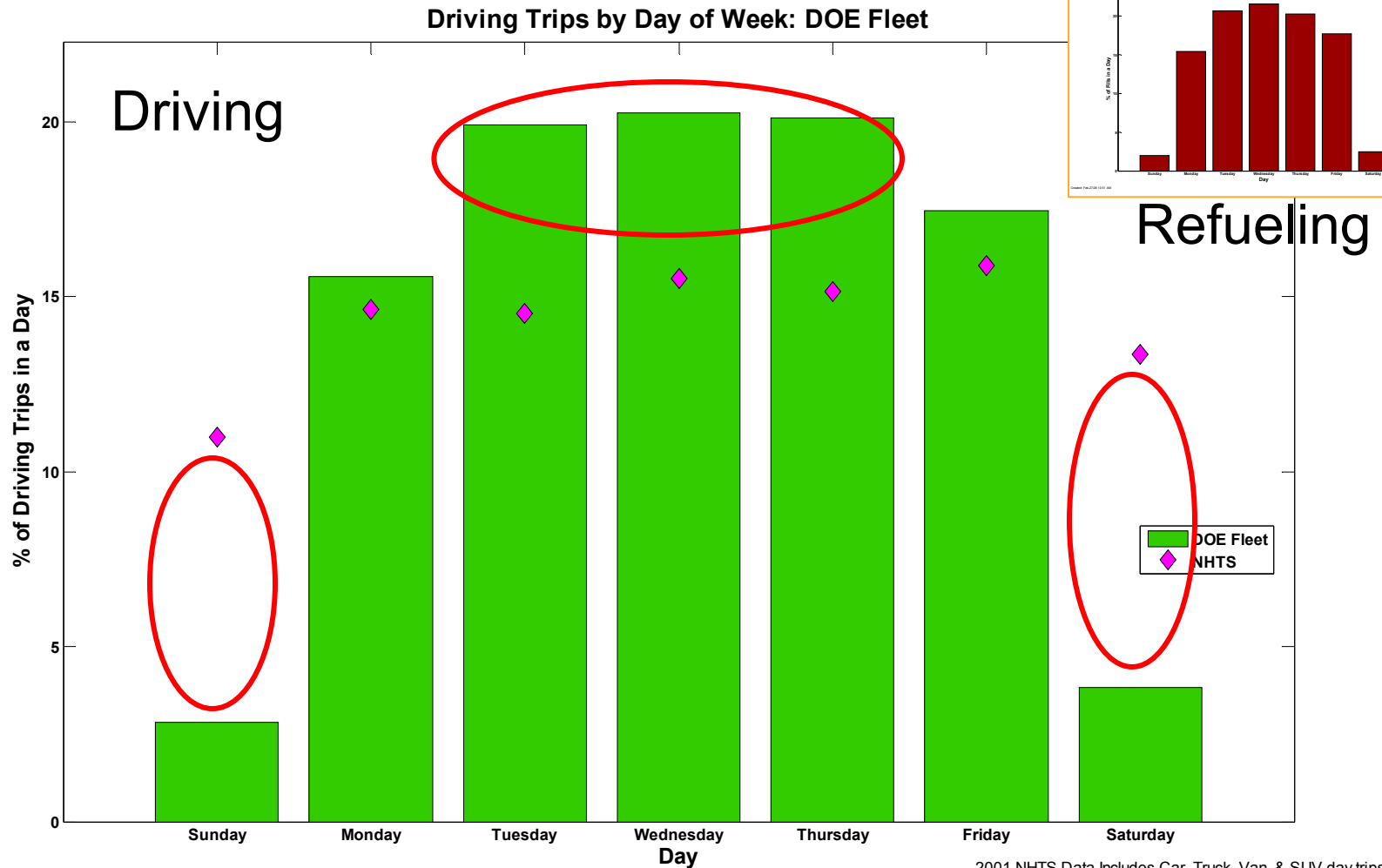

Created: Feb-27-08 10:51 AM

Other CDP Results Not Discussed Here Today

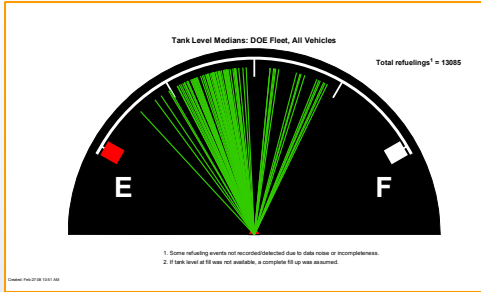

Refueling Tank Levels - Medians

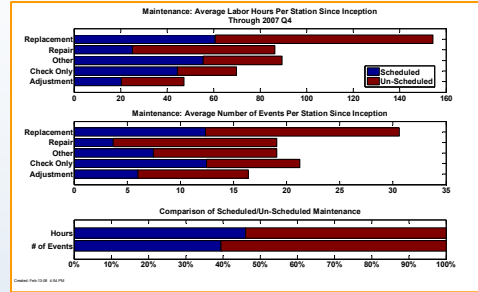

Infrastructure Maintenance

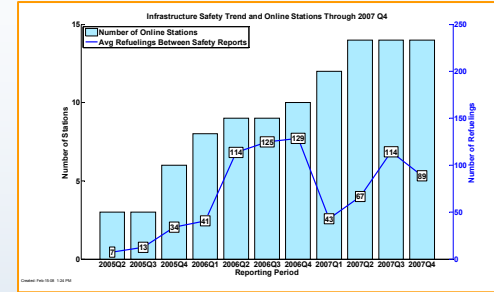

Refuelings per H2 Safety Report

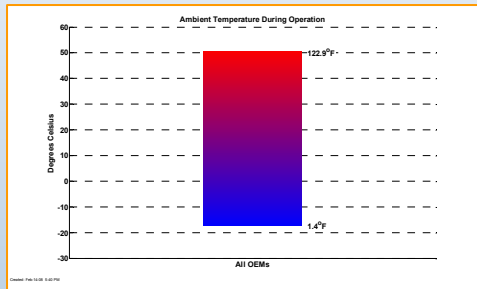

Range of Ambient Temperature During Vehicle Operation



Cumulative Vehicle Miles

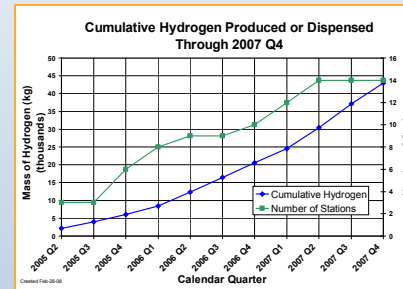

Cumulative H2 Produced or Dispensed

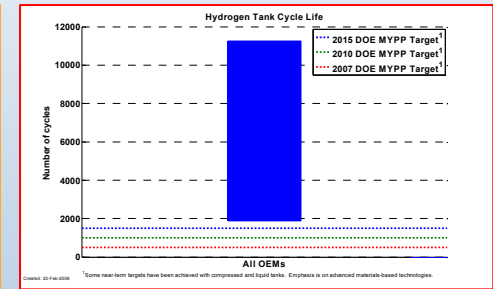

H2 Tank Cycle Life

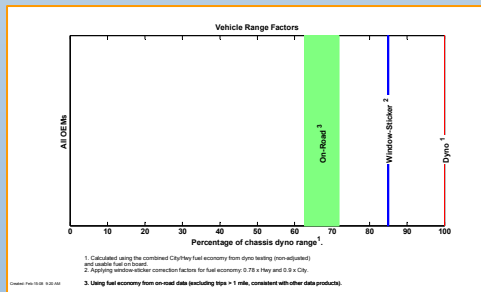

Effective Driving Range

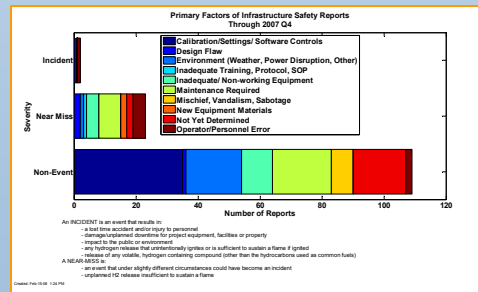

H2 Safety Primary Factors

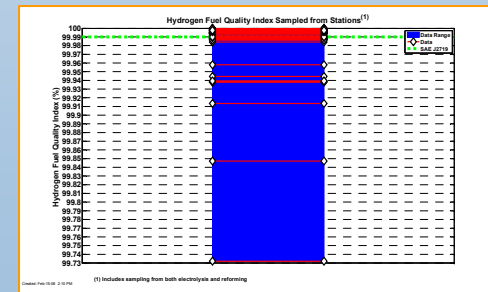

H2 Quality Index

Highlights of Interactions and Collaborations in Last Year

- **Auto/Energy Industry Partners**

- Site visits with industry (at OEM site or NREL) to discuss detailed results and NREL methodology
- Focused on 2-way sharing of stack degradation multivariate work
- Validated NREL's on-road stack degradation analysis technique and results with two OEMs
- Improved methodology for producing detailed data results and CDPs at same time for easier industry review



- **FreedomCAR and Fuel Technical Teams**

- H2 Storage (10/07) and Delivery (11/07) Tech Teams
- DOE's Vehicle Technologies Program and HFCIT Program (10/07)



- **US Fuel Cell Council Technical Working Groups**

- Transportation Working Group – Focus on CA series
- Joint H2 Quality Task Force



- **California Organizations**

- CaFCP: NREL will include H2 impurity test results in future CDPs
- CARB: Discussing data from new stations being sent to NREL for inclusion in analysis results



Future Work

- **Remainder of FY08:**

- Continue to investigate correlations of real-world factors influencing fuel cell degradation
- Create new and updated composite data products (CDPs) based on data through June 2008
 - Prepare results for publication at 2008 Fuel Cell Seminar
- For 2nd generation vehicles, begin to evaluate improvements in FC durability, range, fuel economy, and safety
- Key upcoming September 2008 DOE MYPP and Joule milestone to validate 250-mile range from 2nd generation vehicles
- Support OEMs, energy companies, and state organizations in California in coordinating early infrastructure plans

- **FY09:**

- Semi-annually (spring/fall) compare technical progress to program objectives and targets and publish results
 - Production cost, production efficiency, FC freeze startup and freeze tolerance, 2nd gen stack durability
- Identify opportunities to feed findings from project back into HFCIT program and industry R&D activities to maintain project as a “learning demonstration”
- Help DOE prepare plans for Phase II of project

Summary

- More than half of project completed
 - 92 vehicles and 15 stations deployed
 - 1.1 million miles traveled, 40,000 kg H₂ produced or dispensed
 - 211,000 individual vehicle trips analyzed
 - Project to continue through 2010
- Examination of Factors Affecting FC Degradation Continues
 - NREL collaborating with each team to understand results and refine inputs and analysis
 - Triggered more thorough analysis of vehicle/stack duty cycles, such as time between trips, trip length, FC power levels
- Total of 47 composite data products published to date
 - This presentation only covered some of the new/updated results
 - Web site allows direct web access to all CDPs
- Roll-out of 2nd generation vehicles has begun
 - Most of remaining vehicles to be deployed this year
 - Additional 700 bar stations coming online soon

Questions and Discussion

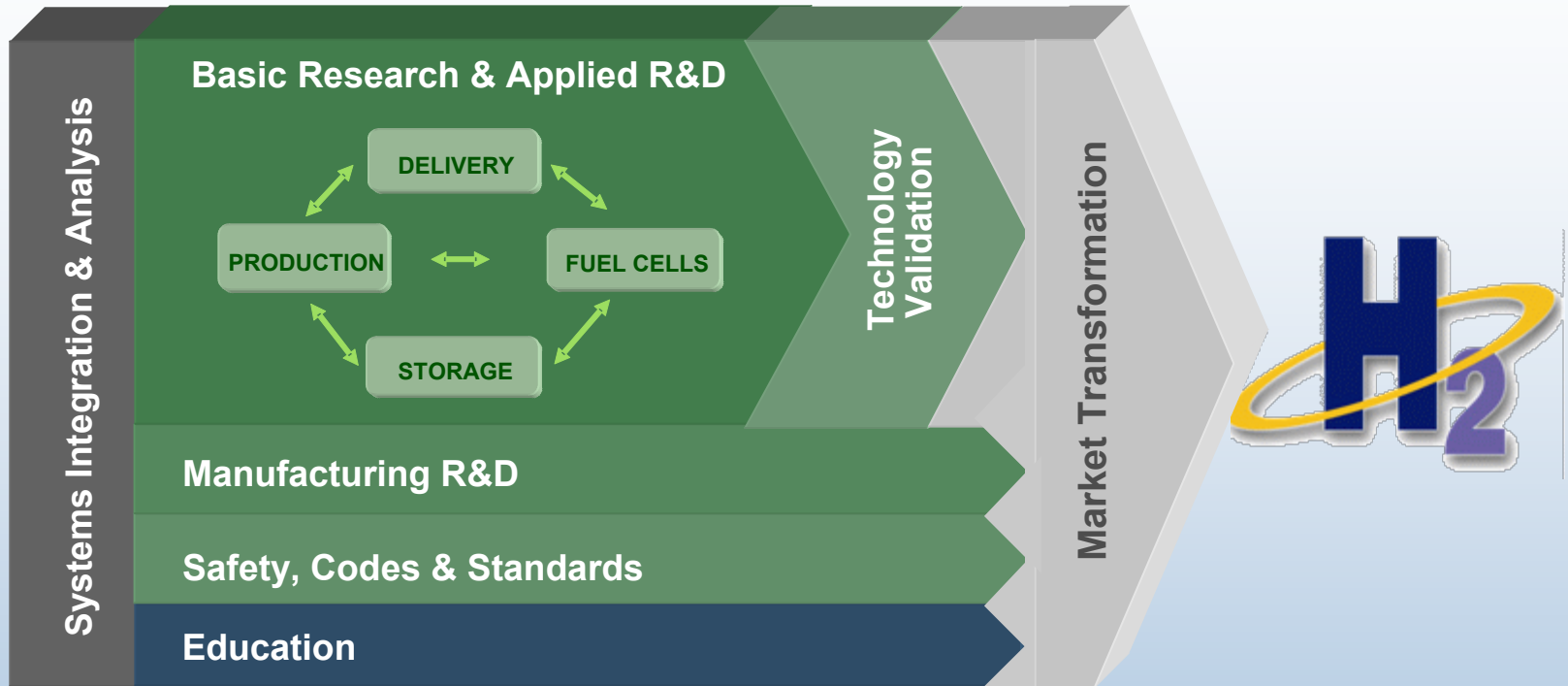

Project Contact: Keith Wipke, National Renewable Energy Lab
303.275.4451 keith_wipke@nrel.gov

All public Learning Demo papers and presentations are available online at http://www.nrel.gov/hydrogen/proj_tech_validation.html