

Solar High-Temperature Water Splitting Cycle with Quantum Boost

Ali T-Raissi, C. Huang, N.Z. Muradov,
S. Fenton, P. Choi, D.L. Block, J. Baik
Florida Solar Energy Center – Cocoa, FL

Robin Taylor, Roger Davenport
Science Applications International Corp. – San Diego, CA

David Genders
Electrosynthesis Company, Inc. – Lancaster, NY

DOE Prime Contract Number: DE-FG36-07GO17002

May 19, 2009

PD_09_TRaissi

Overview

Timeline

- **Start date: SEP 2007**
- **End date: APR 2012**
- **Percent complete: 25%**

Budget

- **Total project funding**
 - DOE share: \$4M
 - Contractor share: \$1M
- **Funding for FY08: \$1.4M**
- **Funding for FY09: \$-0-**

Barriers

- U. High-Temperature Thermochemical Technology
- V. High-Temperature Robust Materials
- W. Concentrated Solar Energy Capital Cost
- X. Coupling Concentrated Solar Energy & Thermochemical Cycles
- H₂ Production Target: **\$3.00/kg**
- Cycle Efficiency Target: **25%**

Partners

- **SAIC (Lead)**
Solar System/Receiver
- **UCF-FSEC**
Process, Reactor/Receiver
- **Electrosynthesis**
Salt electrolysis



Objectives – Relevance (1)

- The focus of this project is to RD&D the viability of a new & improved sulfur family thermochemical water-splitting cycle (*i.e.* sulfur-ammonia cycle, SA) for large-scale hydrogen production using solar energy
- More specifically, our goal is to
 - Evaluate SA water splitting cycle that employs a photocatalytic scheme by which the visible portion of the solar spectrum is utilized for the production of hydrogen
 - Evaluate impact of H₂ production via electrolytic instead of photocatalytic scheme on the performance of the SA cycle
 - Perform economic analyses of the SA based cycles as they evolve
 - Select a cycle that has high potential for meeting the DOE's cost target of **\$3.00/kg hydrogen** generated & efficiency of 25%
 - Demonstrate technical feasibility of the selected SA cycle, in closed loop, at bench-scale
 - Demonstrate pre-commercial feasibility by testing & evaluation of a fully-integrated, pilot-scale closed cycle solar H₂ production plant

Objectives – Relevance (2)

- **RY'09 activities involved:**
 - Completion of the Phase 1 sub-cycle testing & evaluation work with the goal of finalizing the overall configuration of the SA cycle that provides the best opportunity to meet DOE's hydrogen production cost & performance targets – Go-No Go decision to occur in Sept. 2009
 - Continuous development & optimization of the SA cycle's sub-processes
 - Detailed cost analysis (using the H2A platform) of all SA cycle configurations considered in order to identify where further improvements to the cycle could be made

RY '09 (Phase 1) Plan & Approach

- **Sub-cycle Testing & Evaluation**

- Analysis of the SA thermochemical cycle with photocatalytic H₂ production scheme
- Analysis of the SA thermochemical cycle with electrolytic H₂ production scheme
- Lab evaluation of the selected cycle(s) & processes
- Reactor/receiver configuration

- **Solar Concentrator Design**

- Concentrator specifications
- Preliminary concentrator design
- Subsystem testing

- **H2A Cost Analysis**

Photocatalytic SA Cycle (1)

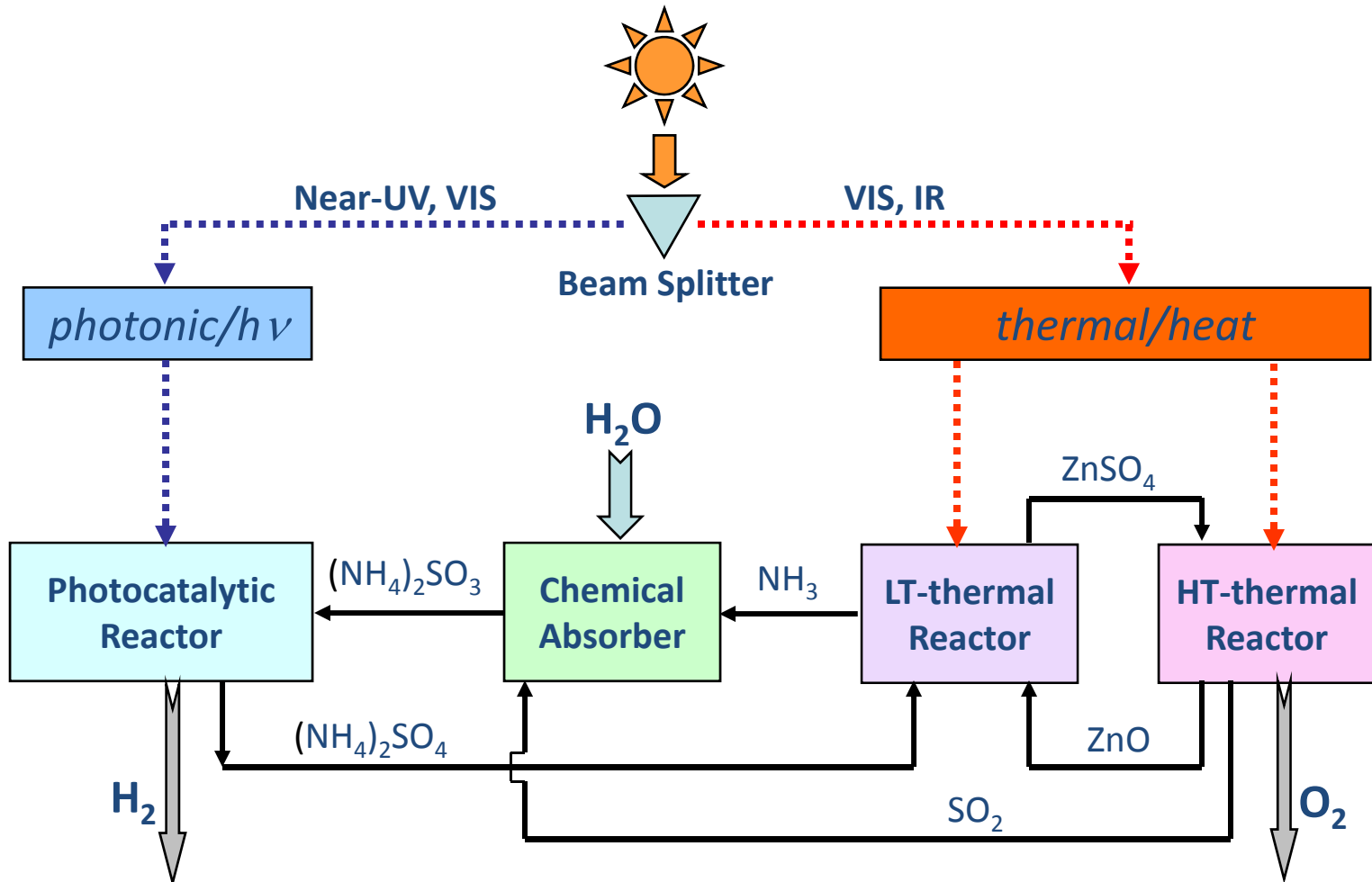

See Supp. Slide 45

Photocatalytic SA Cycle Reactions

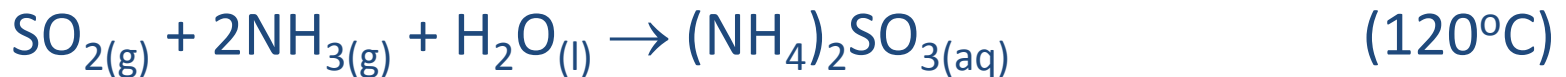
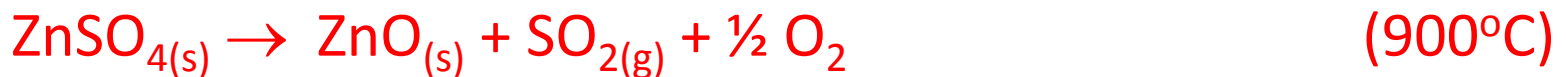
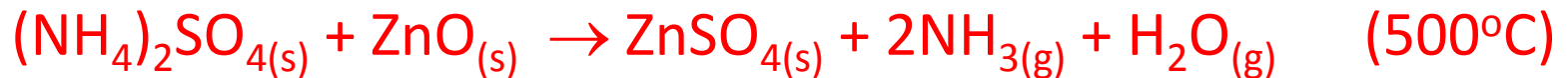
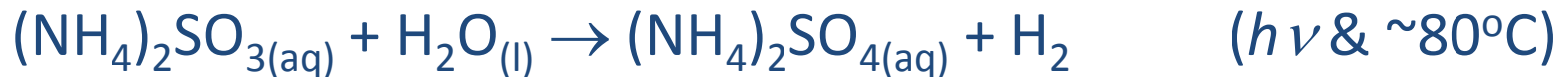

Accomplishments (1)

Photocatalytic-SA Cycle

- Cycle has been closed (Aspen™ flowsheet)
- All reaction steps have been experimentally validated
- No side reactions occurred
- All chemicals & reagents used in the cycle are readily available
- All materials of construction & component challenges have been addressed
- Overall efficiency of the dual-field photocatalytic SA cycle is not likely to meet the DOE target of 25%
- Hydrogen production cost for the photocatalytic SA cycle with split beam arrangement is not likely to meet the DOE target of \$3.00/kg

Accomplishments (2)

Photocatalytic-SA Cycle

- **Demonstrated successes**

- Photocatalyst optimization improved the photon-to-H₂ energy conversion efficiency from less than 12% (year & half ago) to more than 28% (recently) using CdS doped with multi-metal co-catalysts
- Stability of the photocatalyst has been demonstrated over many days of continuous operation
- Non-Pt dopants have been identified having close to 20% photon-to-H₂ energy conversion efficiency
- The chemistry of ZnO sub-cycle for oxygen evolution has been thoroughly investigated & shown to be “clean”, with no undesirable side reactions occurring
- Ammonium sulfate reacts with ZnO forming ZnSO₄, ammonia & water vapor at temperatures below 500°C
- Complete decomposition of zinc sulfate occurs at temperatures as low as 900°C, producing ZnO, oxygen and SO₂ gas

Photocatalytic SA Cycle Strengths

- **Solar cycle:** Employs photonic and thermal components of the solar resource. Does not need electric power to operate hydrogen production process
- **Simple separations:** There are no complex gas and/or liquid separation stages involved
- **Simple photoreactor design:** The photo-catalytic reactor operates at near ambient conditions & can be made from low-cost materials

Photocatalytic SA Cycle Weaknesses

- **Employs noble metals:** Pt makes up 70 wt% of dopants & close to 60 wt% of total cost of chemicals & reagents used in the cycle
- **Large photoreactor footprint:** If dual field configuration is used
- **Spectral beam-splitting:** Splitting solar spectrum allows higher cycle efficiency at the cost of complexity and a larger heliostat field. Separation of the photoreactor and thermal solar fields yields lower solar efficiency but potentially lower hydrogen production cost due to increased land use

Electrolytic SA Cycle

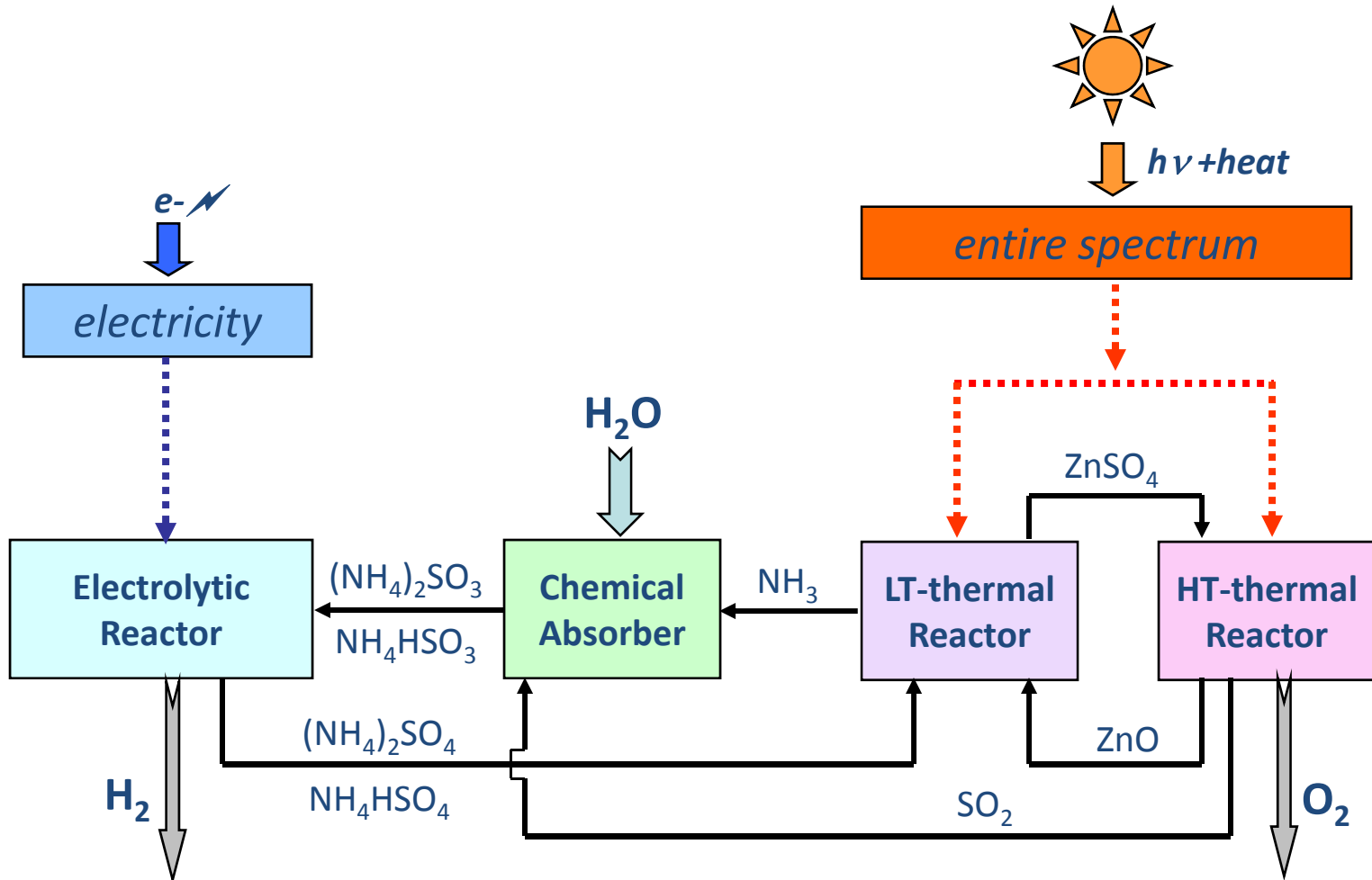

Electrolytic SA Cycle Reactions

In the electrolyzer operating at ~50-60°C:

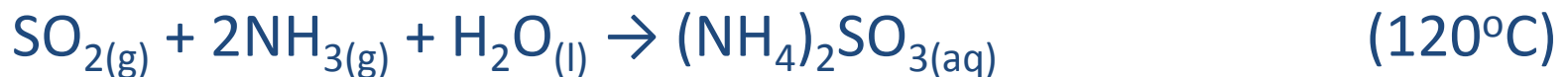
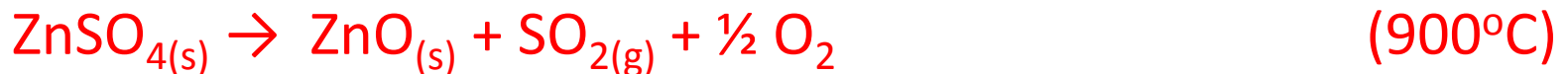

Electro-Oxidation of Ammonium Sulfite

Single Cell Results (1)

GFD anode, NRE111 MEA cathode ($\sim 2\mu\text{g Pt}/\text{cm}^2$)

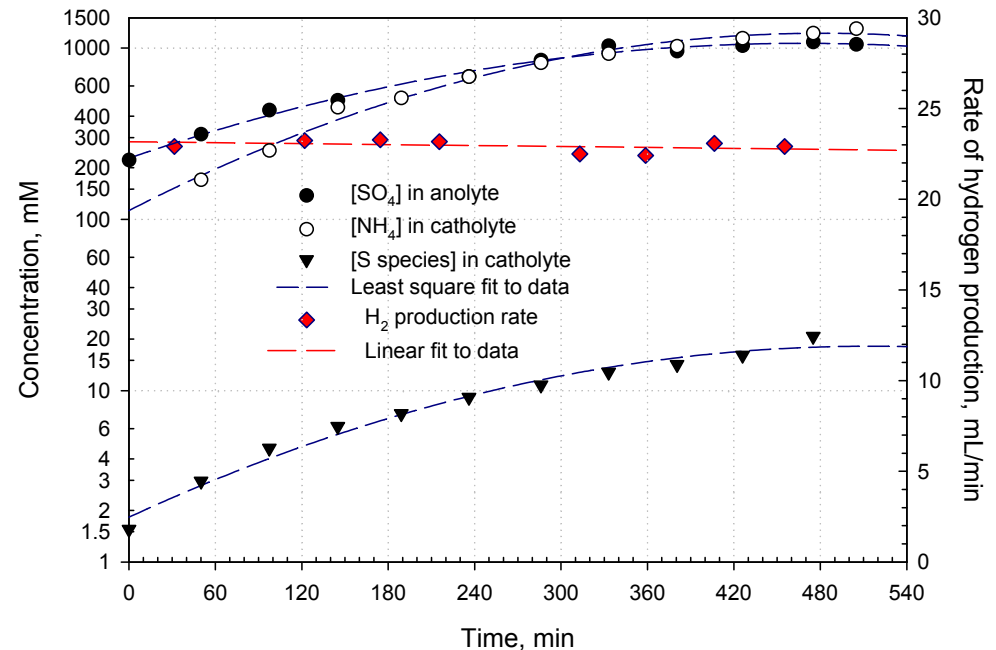
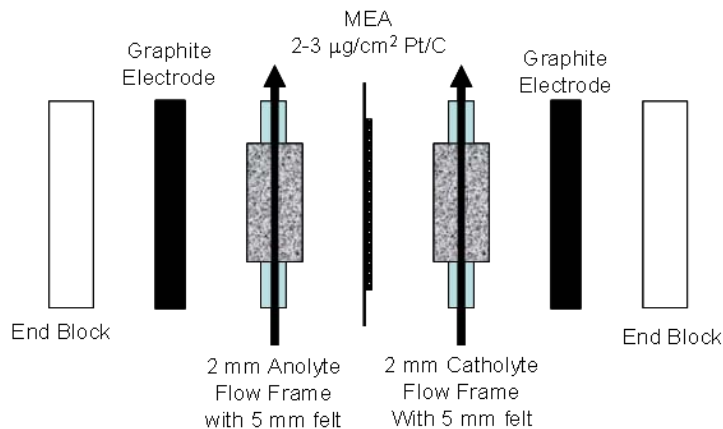

➤ Quantitative hydrogen evolution & sulfite oxidation

Electro-Oxidation of Ammonium Sulfite

Single Cell Results (2)

GFD anode, NRE111 MEA cathode ($\sim 2\mu\text{g Pt}/\text{cm}^2$)

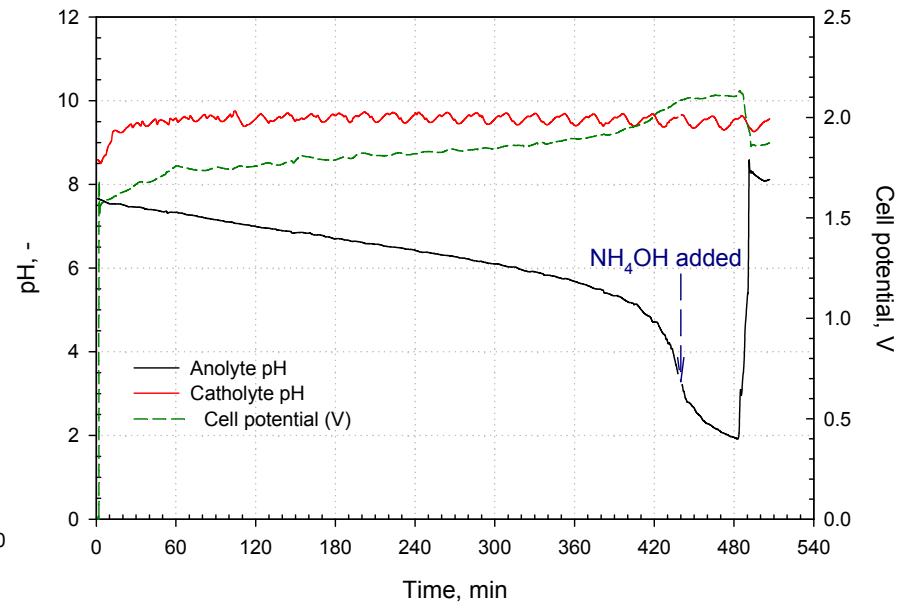
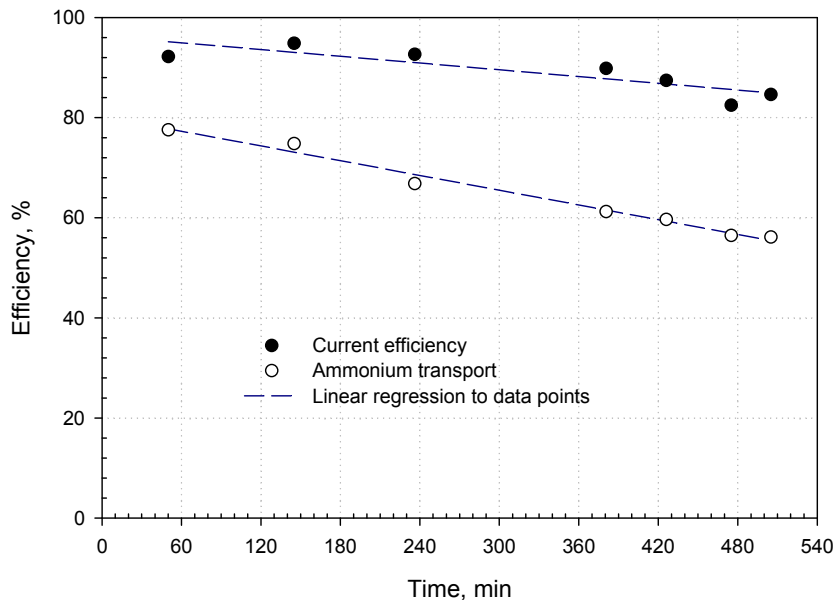

➤ Transport number for ammonium ion across membrane ≈ 0.6

➤ Cell Voltage is pH dependent

Electro-Oxidation of Ammonium Bisulfite

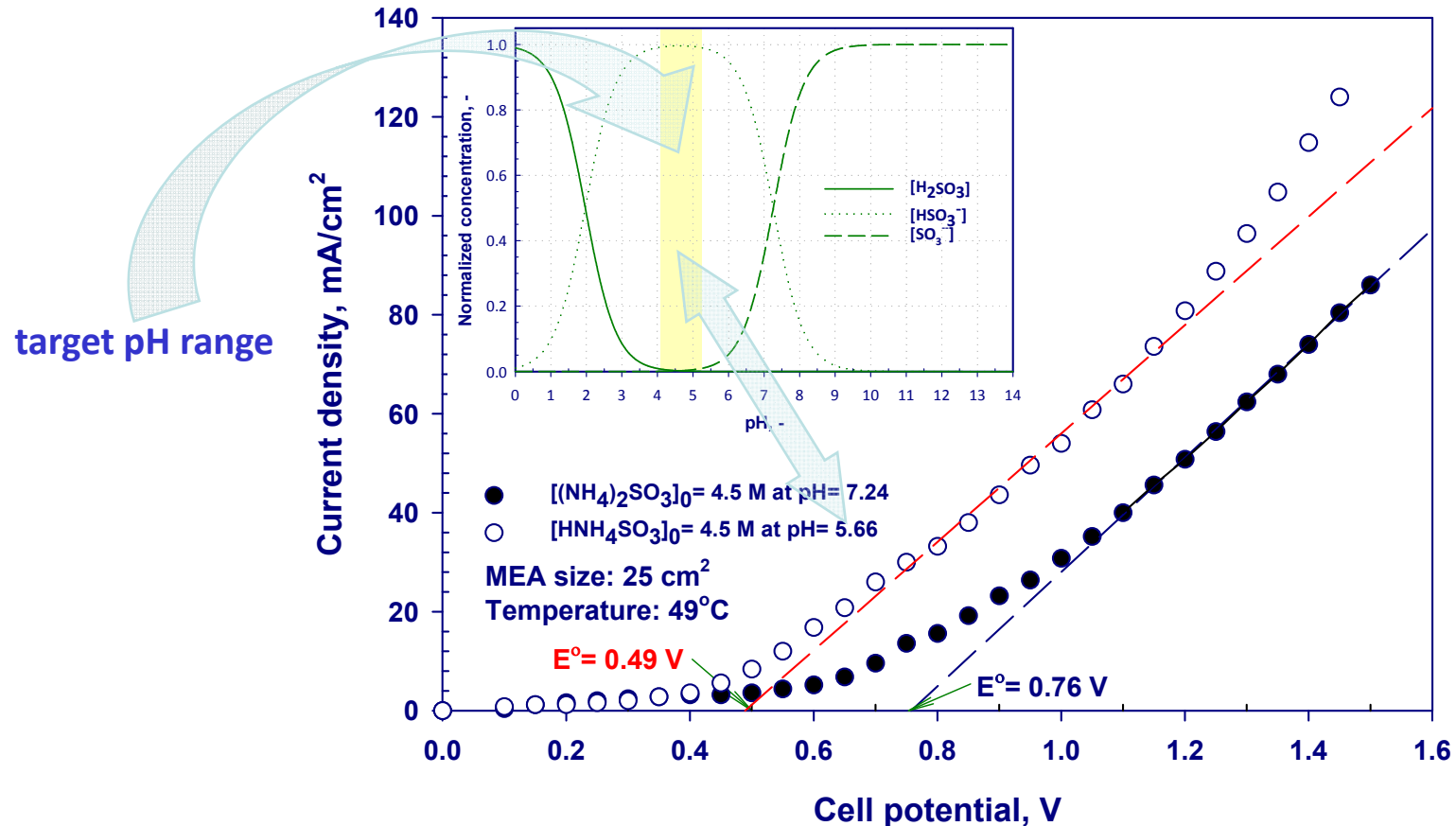

➤ Open circuit voltage of bisulfite oxidation in acidic media is less than that of sulfite

Electrolytic SA Cycle

Strengths & Weaknesses

- **Strengths**

- Small footprint
- High current efficiency
- Potentially lower capital cost than photocatalytic hydrogen production
- 24-7 operation possible

- **Weaknesses**

- May require noble metal electrodes
- Low current densities at low cell overpotentials
- 24-7 operation requires high temperature TES to keep the oxygen production sub-cycle running

Oxygen Production Sub-Cycle



Alundum-supported zinc oxide

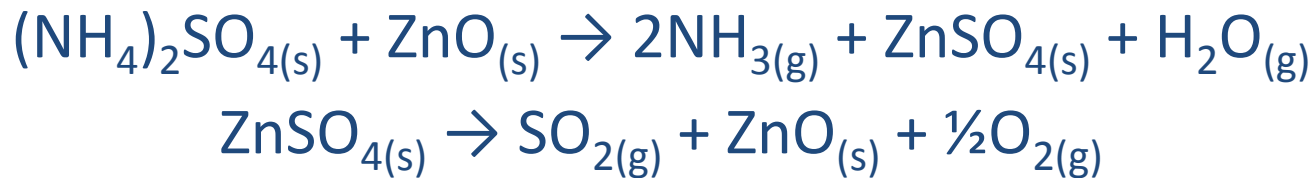
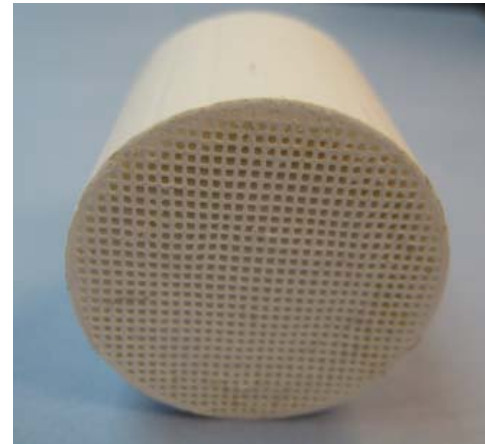

XRD of ZnO-(NH₄)₂SO₄ (1:1 mol) Mix Reacted at 500° & 900°C

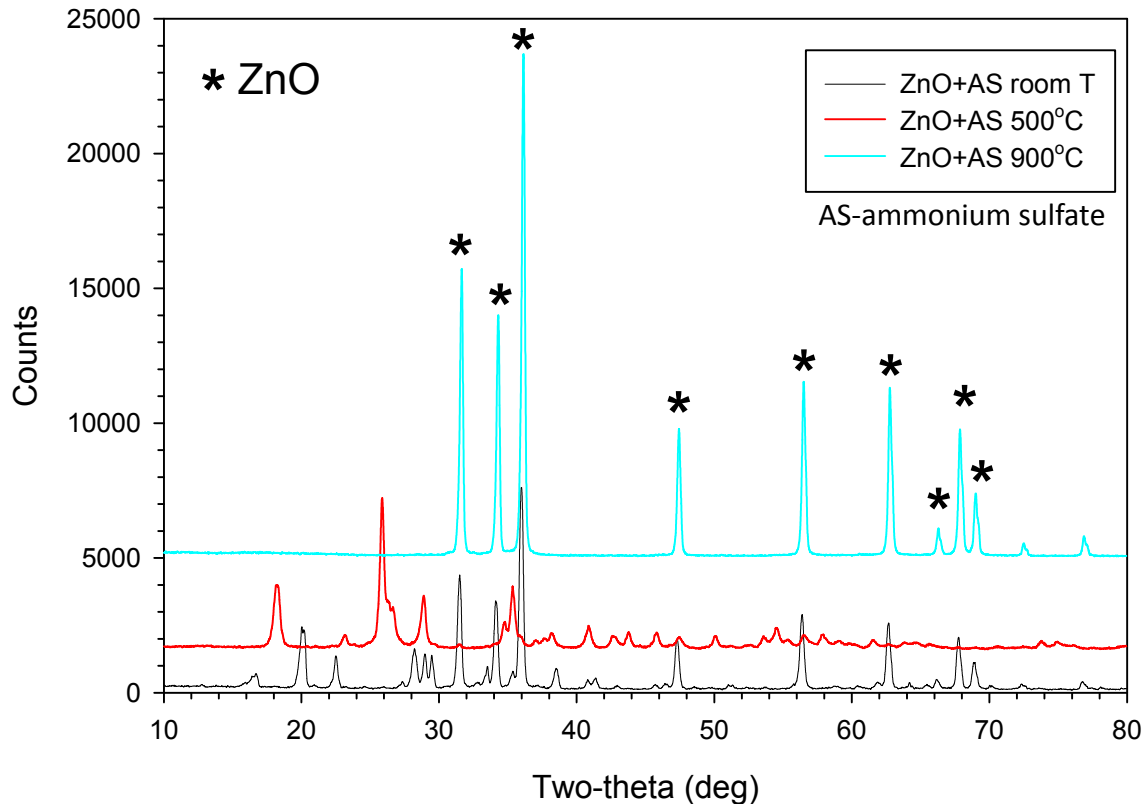

ZnO reacts with (NH₄)₂SO₄ at 500°C forming ZnSO₄, & ZnO is completely regenerated at 900°C

XRD of ZnO- Alundum Mix

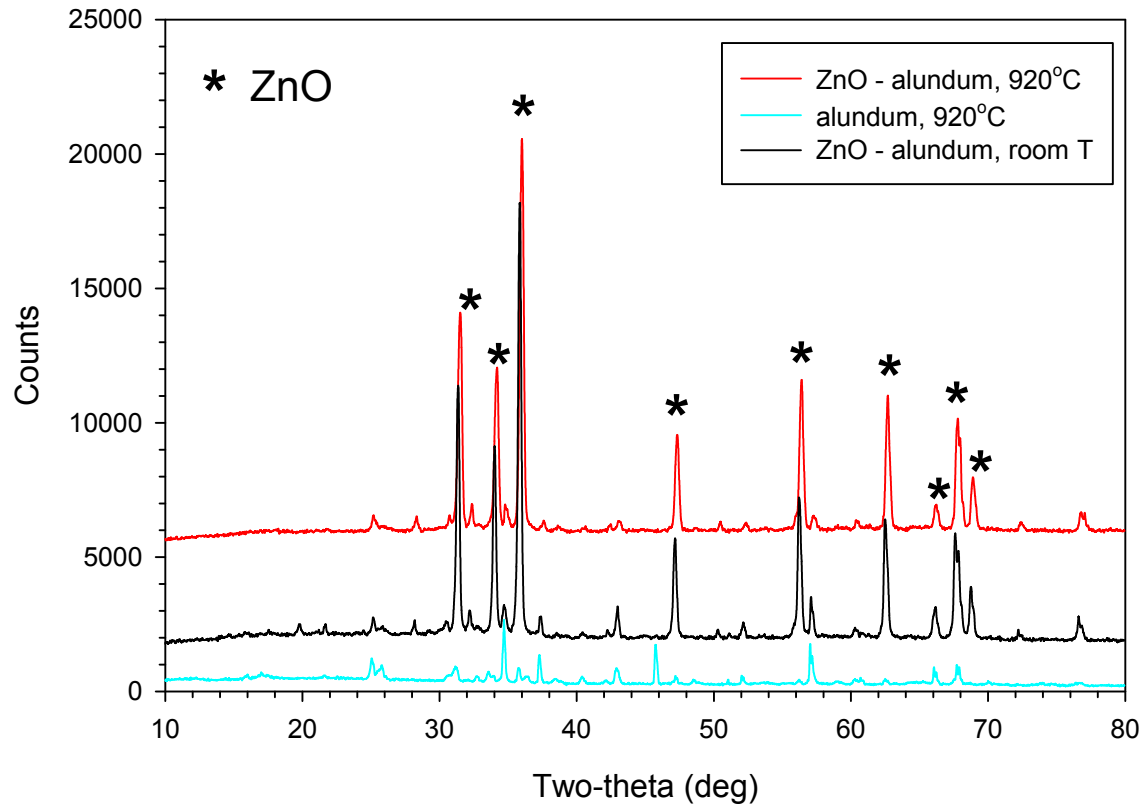

**ZnO does not react with alundum support
at temperatures up to 920°C**

K_2SO_4 Sub-Cycle for O_2 Production (1)

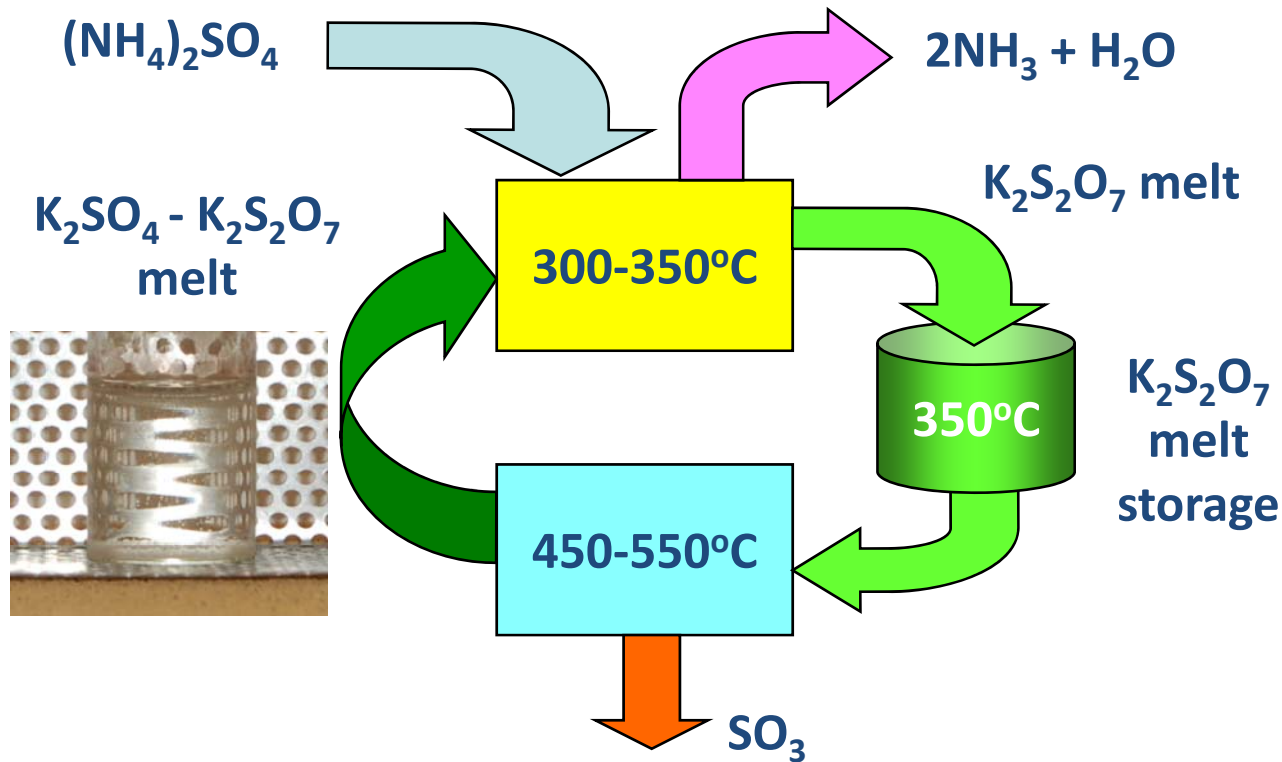
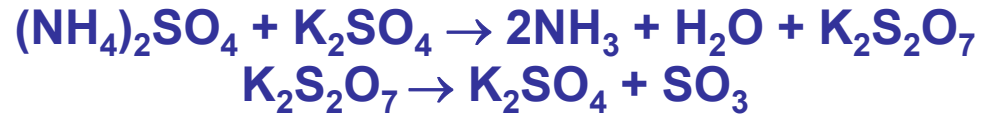

K_2SO_4 sub-cycle allows transportation & high-temperature storage of the intermediate salts in liquid (melt) form

K_2SO_4 Sub-Cycle for O_2 Production (2)

TG/DTA of $(NH_4)_2SO_4 + K_2SO_4$ (1:1 mol) mixture at $5^\circ C/min$

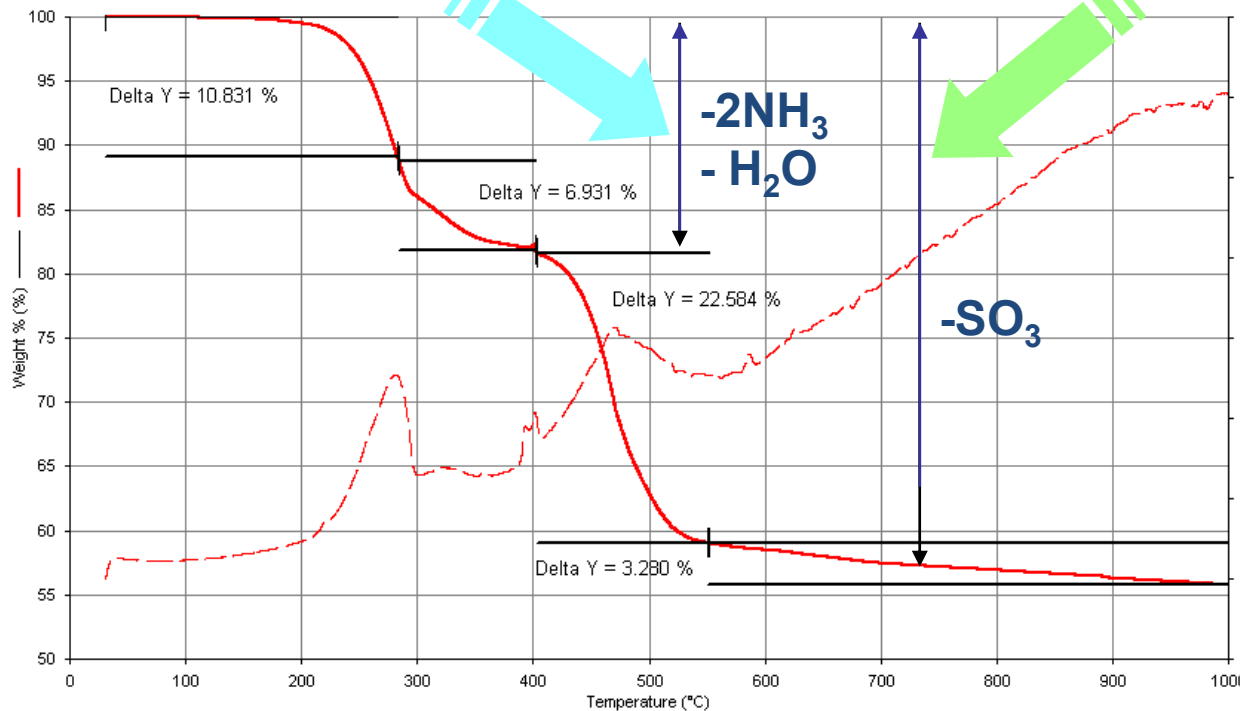

A broad temperature plateau of about $150^\circ C$ allows straightforward NH_3 & SO_3 separation

K₂SO₄ Sub-Cycle for O₂ Production (3)

TG/DTA of (NH₄)₂SO₄: M₂SO₄ = 1:1 (mol) mixture, M = Na, K, Ru, Cs

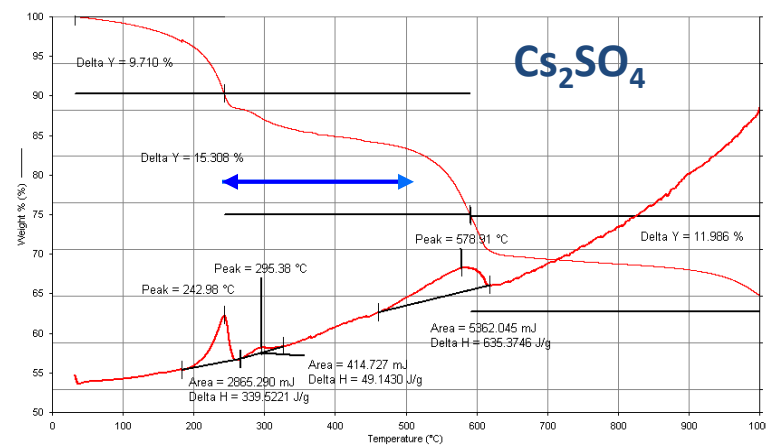
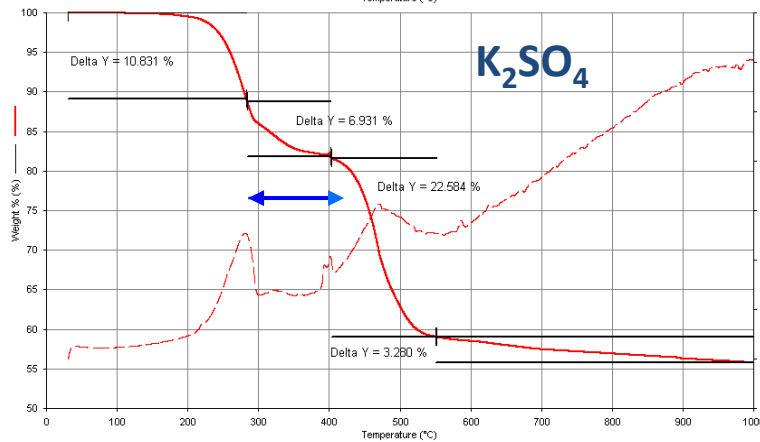
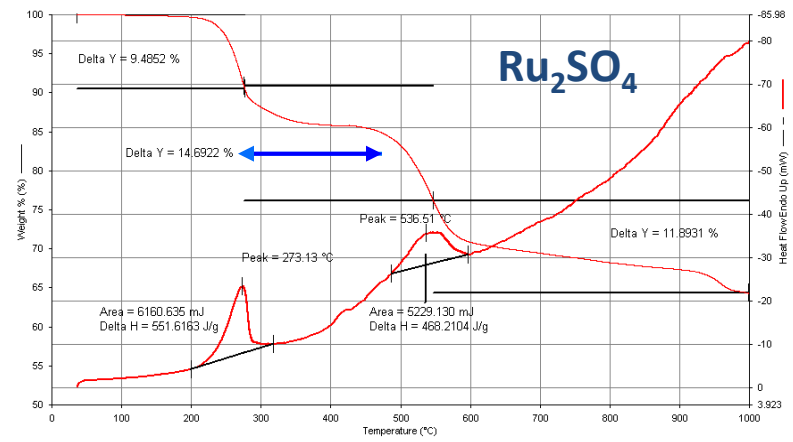
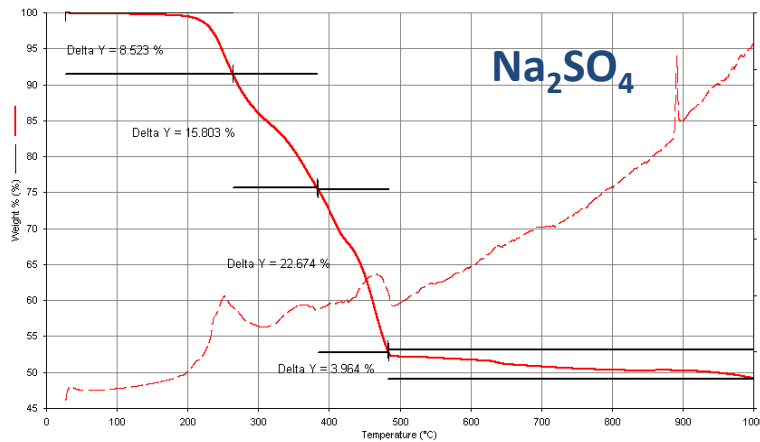

K₂SO₄ is the least costly with the broadest temperature plateau of all alkali metal sulfates tested for facile separation of NH₃ & SO₃

Aspen™ Flowsheet of SA Cycle

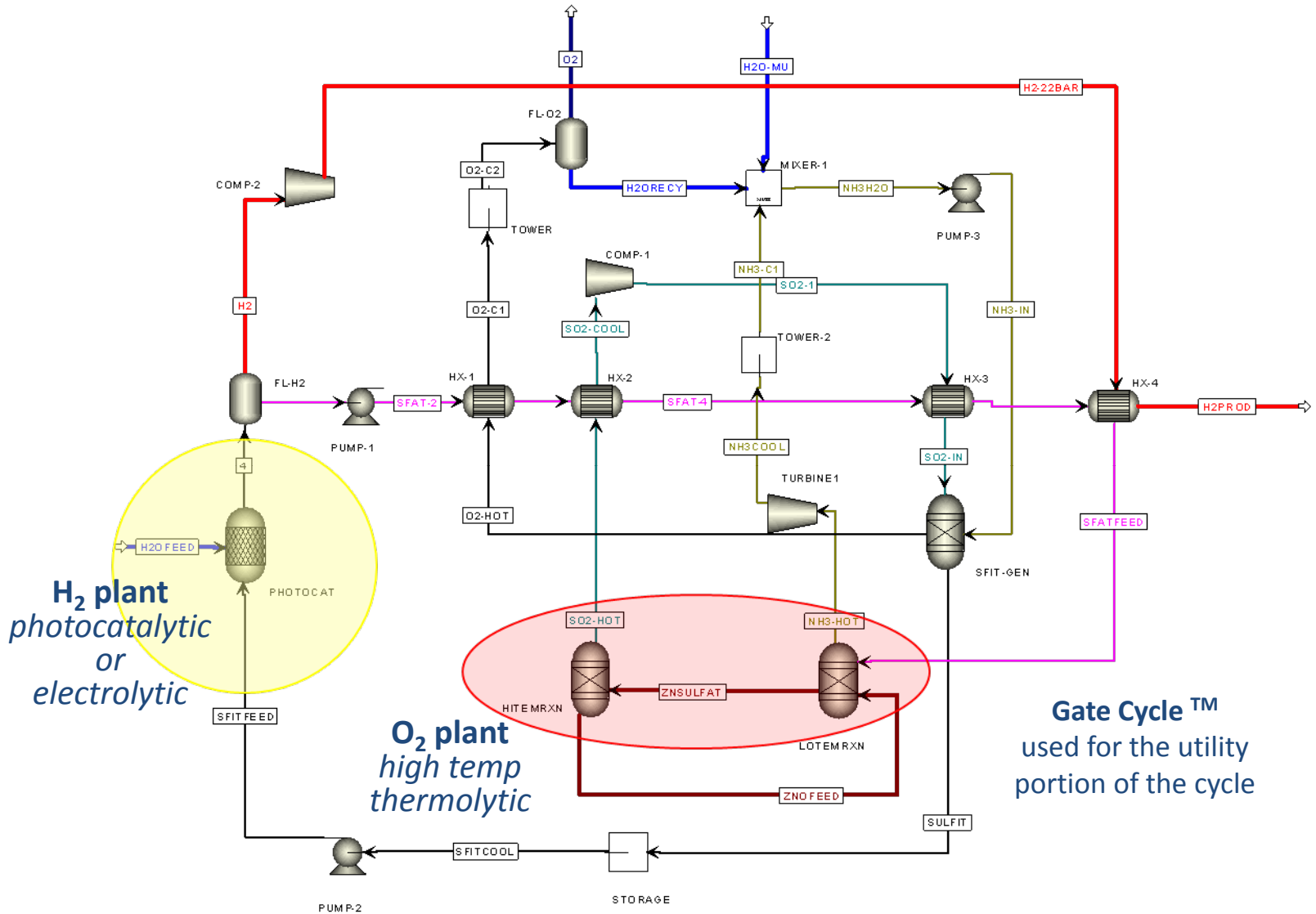

Approach

Solar Interface Issues

- Configure solar field optimally for integration with thermochemical plant
- Develop low-cost heliostat to reduce capital cost of solar field (this benefits any heliostat-based system – solar power, hydrogen,)

Technical Progress (1)

- **Photoreactor System Evaluation**

- Best beam-splitting configuration determined to be North-field heliostat field with cold mirror near focus & South-field photoreactors operating at ~ 2 suns

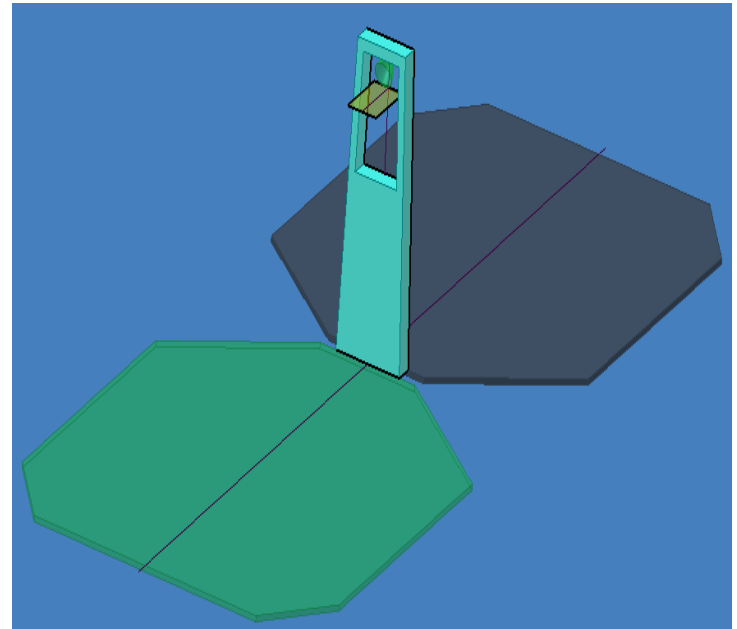

- Most cost-effective approach overall is central receiver system for thermal loads & separate one-sun photoreactor field

Technical Progress (2)

- **Central receiver system and receivers optimized to deliver energy to low-temp and high-temp reactors of S-A process**
 - 125 m tower, 68,800 m² of North-field heliostats
 - 2/3 – 1/3 split in power between reactors; Temperatures of 500°C and 800°C
 - 6 m² aperture high-temp receiver, 700 suns max
 - 8.5 m² aperture low-temp receiver, 900 suns max
 - Heliostat aim points moved between receivers to balance power requirements in real time
 - 45-55 MW_{th} peak power, approx. 140 GWh_{th} annually delivered to chemical reactors

Technical Progress (3)

- **Demonstrated low-cost glass-reinforced concrete (GRC) heliostat system**
 - Half-scale prototype completed & undergoing tests
 - Demonstrated viability of fabrication approaches
 - Demonstrated drive system features & controls
 - Installed system cost projected $< \$100/\text{m}^2$



H2A Analysis

Photocatalytic SA Cycle

- H2A analysis has been completed
- Preliminary value with TIAX comments incorporated is **\$5.31/kg (2015)**.
 - Added staffing, replacement costs, 3-year construction time, taxes, chemical equipment installed costs, \$126.50 heliostats, indirect costs, maintenance & repair costs

H2A Results

Photocatalytic SA Cycle

<i>Specific Item Cost Calculation</i>		
Cost Component	Cost Contribution (\$/kg)	Percentage of H2 Cost
Capital Costs	\$5.09	96.0%
Decommissioning Costs	\$0.01	0.2%
Fixed O&M	\$1.69	31.8%
Feedstock Costs	\$0.00	0.0%
Other Raw Material Costs	\$0.00	0.0%
Byproduct Credits	-\$1.50	-28.2%
Other Variable Costs (including utilities)	\$0.01	0.3%
Total	\$5.31	

Collaborations

- **Partners**

- **Science Applications International Corp. (Industry)**

- Contract management & LEAD
 - Solar concentrator/receiver development & system integration
 - Pilot & full-scale system design & costing

- **UCF/Florida Solar Energy Center (Academic partner)**

- Cycle & process development, evaluation & selection
 - Reactor/receiver & system level design & optimization

- **Electrosynthesis Company, Inc. (Industry & sub)**

- Salt electrolysis
 - Electrolytic cell design & optimization

Electro-oxidation of Ammonium Sulfite – Future Work

- Anodic oxidation of sulfite & the cathodic hydrogen evolution reaction are pH dependent
 - $\text{SO}_4^{2-} + 4 \text{H}^+ + 2 \text{e}^- \leftrightarrow \text{H}_2\text{SO}_3 + \text{H}_2\text{O}$ $E^0 = +0.172 \text{ V/nhe}$
 - $\text{SO}_4^{2-} + \text{H}_2\text{O} + 2 \text{e}^- \leftrightarrow \text{SO}_3^{2-} + 2\text{OH}^-$ $E^0 = -0.930 \text{ V/nhe}$
- Main source of voltage loss is due to the anode losses
 - Target cell voltage <1V
 - Find conditions where anode can be run at high pH without adverse effect on localized pH changes
 - **Introduce some buffering capacity into the solution**
 - **Explore the use of anion exchange membranes as the basis for the MEA**
 - **Explore the use of undivided cells**
 - **Need to maintain pH conditions where the sulfite will not be further reduced**
 - Find catalysts that will reduce the over-potential at the anode and allow operation at high current densities
 - Examine molten salts
- Recombine anolyte & catholyte streams to maintain fixed pH

Solar Interface – Future Work

- Refine solar field and receiver design as chemical plant needs evolve
- Detailed production cost estimate for GRC heliostat system based on prototype test results
- Full-scale prototype of pre-commercial GRC heliostat design

SA Cycle – Future Work

- **Completion of phase 1 activities**
 - Document photocatalytic-SA cycle results
 - Complete electrolytic H₂ production tests
 - Finalize thermal reactor/receiver design
 - Finalize solar field configuration & design
 - Complete electrolytic H₂A analysis

Summary

- Photocatalytic-SA cycle is not likely to meet DOE's hydrogen production cost goals without a major effort to reduce the cost of hot mirrors to allow SB implementation
- Electrolytic SA cycle is in early development stage, so further performance improvements & cost reductions are likely
- Electrolytic-SA cycle has potential to meet DOE's hydrogen production and efficiency goals
- GRC has promise to reduce heliostat cost

Questions?

Supplemental Slides

Milestones, Schedule & Deliverables

Month Year	Type	Description/Requirements	Status
Aug /Sep '09	Activity	Develop & optimize the processes that make up the SA water-splitting cycle so that the cycle can meet the DOE cost & performance targets	Nearing Completion
		Complete preliminary design of solar concentrator for pilot-scale system	
		Incorporate know-how from sub-cycle work & those obtained from the H2A analysis into the design of the fully integrated bench scale system	ongoing
Sep '09	GO/ NO-GO To Phase 2*	The SA cycle has been shown to meet DOE's cost & performance goals, and non-federal cost share is in place for Phase 2	
Sep '10	Activity	Build, test & operate the fully integrated closed loop bench-scale SA cycle	Future Activities
Sep '10	GO/ NO-GO To Phase 3#	Bench-scale results for the fully integrated closed SA cycle is shown to be technologically feasible & able to meet DOE's hydrogen production cost & performance targets for 2010 (\$3/kg of H ₂ or less) to support scaling-up to pilot-scale demonstration	
Mar '11	Activity	Design or identify a suitable solar concentrator for the pilot-scale experiments. Begin the design of the pilot-scale receiver/reactor	
Nov '11		Complete the hardware set up for the solar concentrator & receiver system	
Apr '12	Report	Complete testing of the full-scale system. Compile the data and prepare final report on the cost figures & recommendations for further development	

* Bench-scale testing of the complete cycle & pilot plant design # Pilot-scale demonstration

Photocatalytic SA Cycle (2)

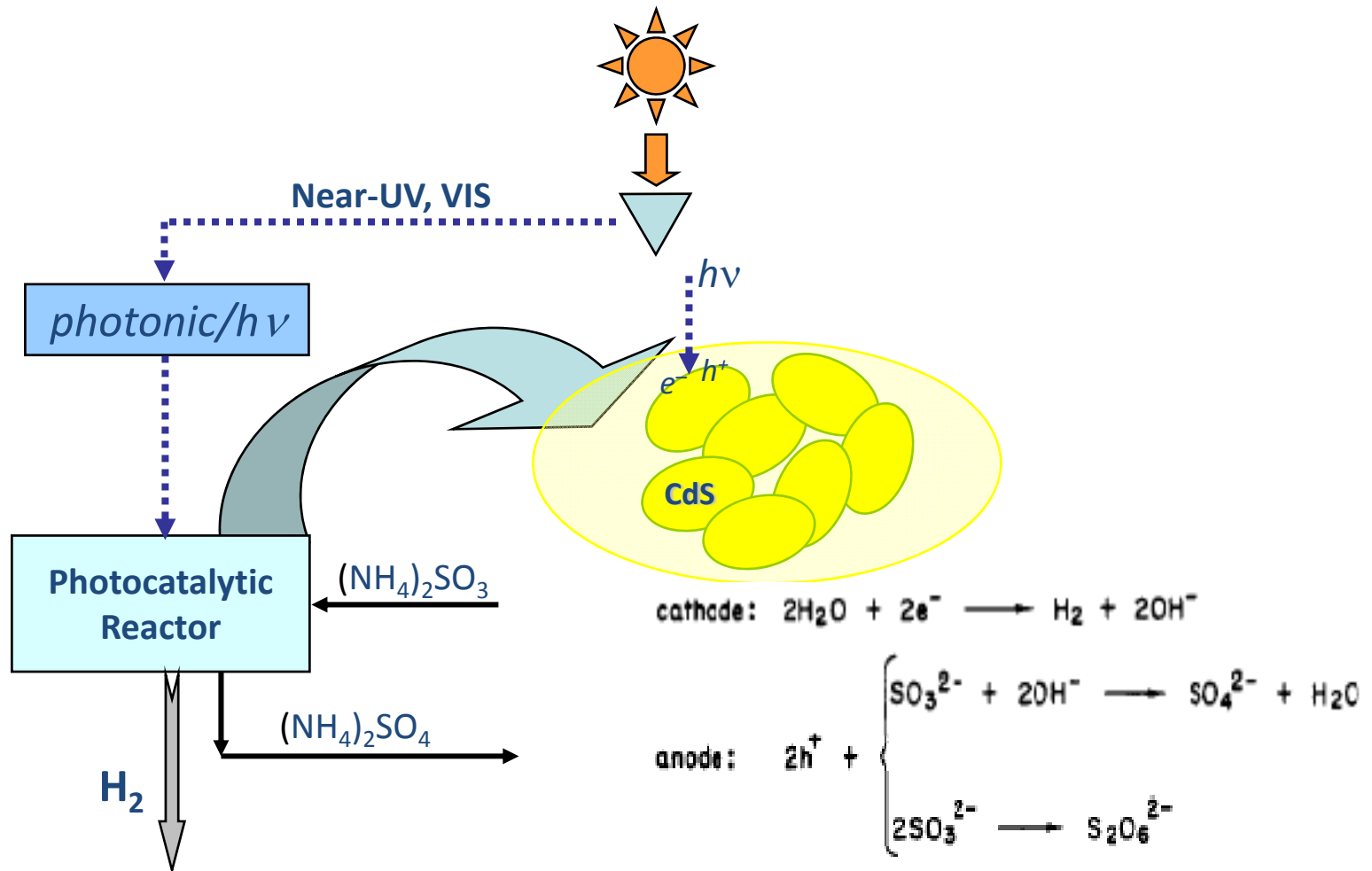

Optimization of Hydrogen Production Photocatalysts



Effect of Photocatalyst Doping

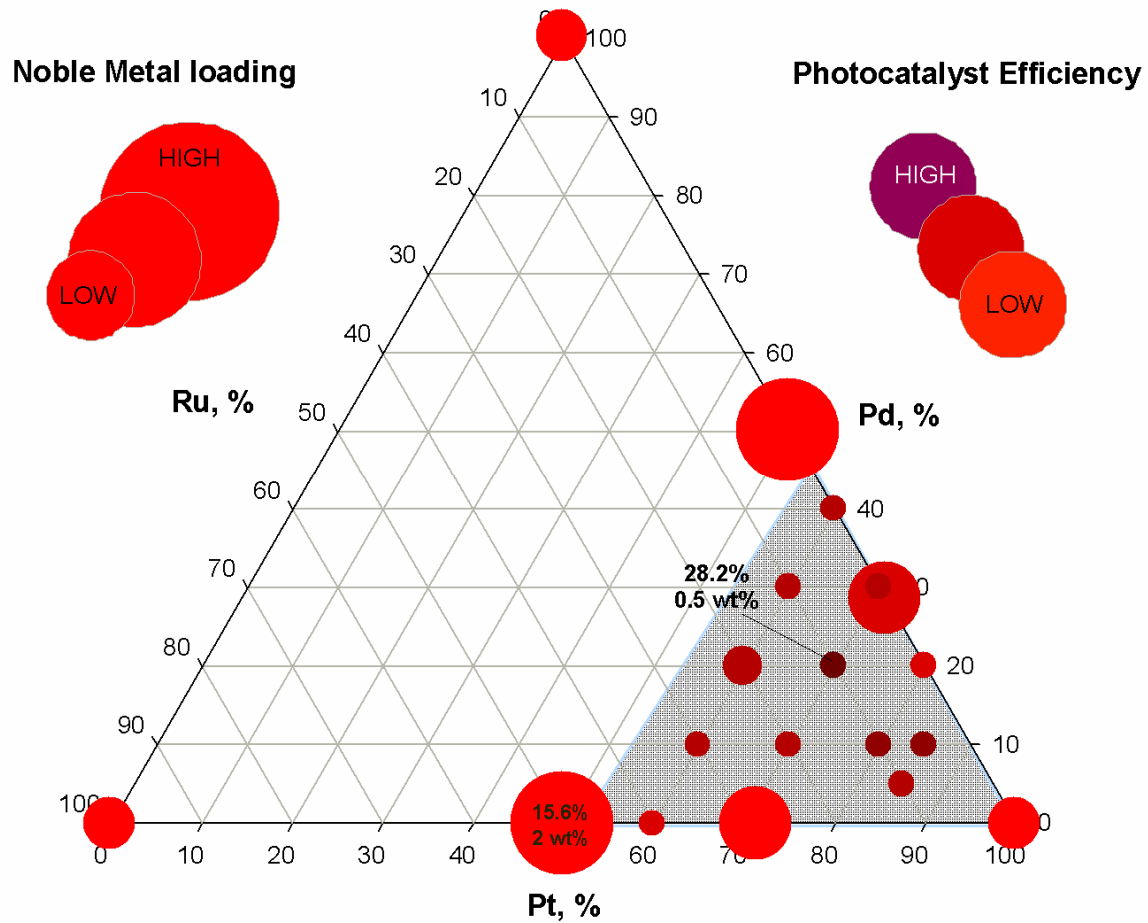

Photocatalyst: 0.5wt% NM on CdS; Photolyte: 1M $(\text{NH}_4)_2\text{SO}_3$

Effect of Photoreactor Window Material

Photocatalyst: 0.5 wt% NM (70%-Pt, 20%-Pd, 10%-Ru) doped CdS
 CdS loading: 0.50 g
 Photolyte: 300 mL of 1M (NH₄)₂SO₃ at room temperature

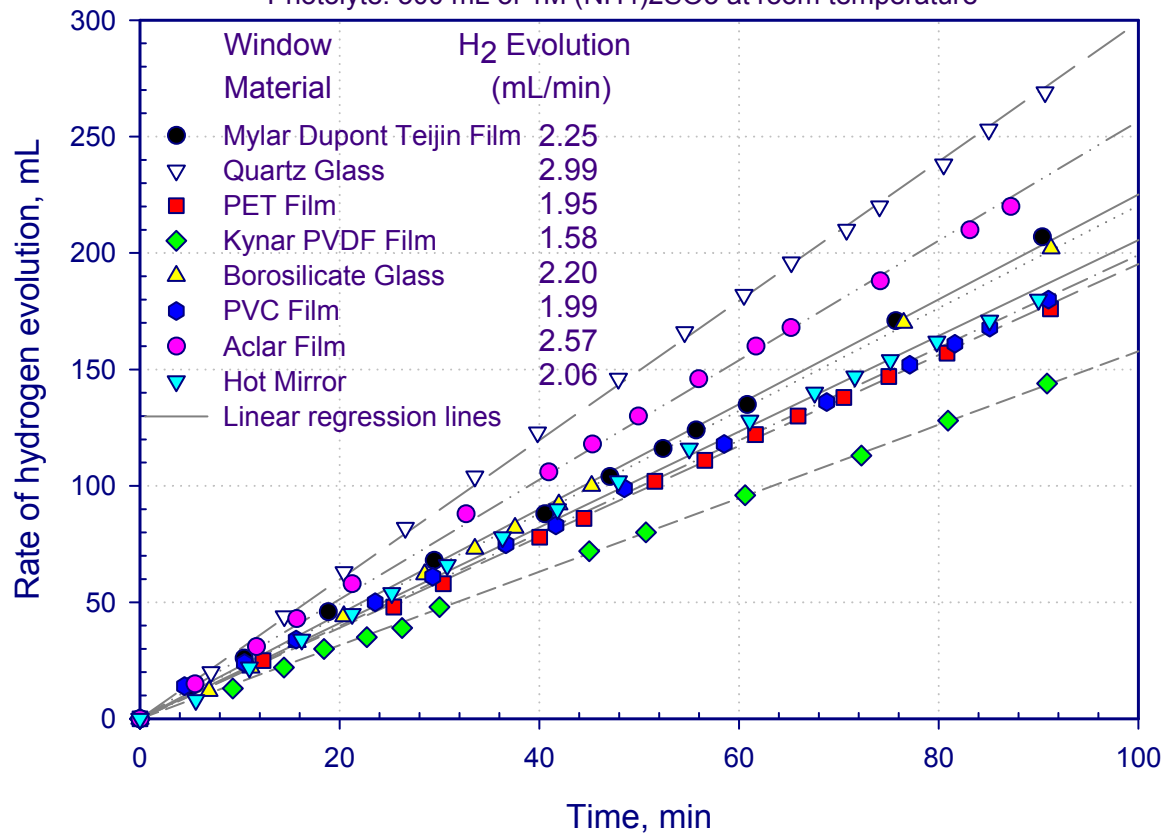

Electro-oxidation of Ammonium Sulfite - Summary

Cathode	Cell Voltage (V)		
	10 mA/cm ²	40 mA/cm ²	100 mA/cm ²
ELAT GDE	1.14	1.40	1.71
Ni mesh	1.50	1.68	2.29
Pt/Nb mesh		1.95 @ 20°C 1.62 @ 60°C	1.95 @ 60°C
MEA, N112 (30 mg Pt/cm ²)	1.01	1.41 @ 20°C 1.21 @ 60°C	1.50 @ 60°C
MEA, N111 (\approx 2 μ g Pt/cm ²)			1.40 @ 80°C

- Hydrogen produced quantitatively
- Very low Pt loading achieved
- Over-potential on anode side still very high
- Anode potential pH sensitive

Mechanisms of ZnO/(NH₄)₂SO₄ Decomposition

Step 1 (T ~400-500°C):



Step 2 (T < ~900°C):



Step 3 (T > ~900°C):

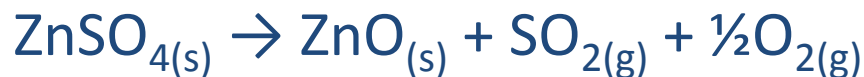

Materials Challenges

- **Reduction or elimination of noble metal catalysts to reduce cost**
 - Reduce Pt by exchanging with less expensive NM (*e.g.*, Pd, Ru)
 - Non-NM dopants (*e.g.*, Cr, etc.)
- **Low-cost heliostat development**

Challenges Facing Photocatalytic-SA Cycle Development

- **Noble metal loading**

- Photocatalyst is a bandgap semiconductor (CdS)
- Pt is 70% by wt. of NM loading and accounts for close to 60% of the total cost of chemicals & reagents utilized in the cycle

- **Potential solutions**

- Reduce Pt loading by mixing with co-catalysts (Ru, Rh) to optimize catalyst activity
- Exchange Pt for non-NM catalyst that is more cost-effective

Other SA Cycle Issues Needing Refinement

- **Thermolytic reactors**

- **Low-temperature reactor (~500°C)**

- Ammonium sulfate reaction with ZnO to produce NH_3 , H_2O & ZnSO_4
 - Mixing & reaction of solids with evolution of gases

- **High-temperature reactor (~900°C)**

- Decomposition of ZnSO_4 to ZnO , SO_2 & O_2
 - Evolution of gases from solid reactant

Potential Solutions/Approaches (1)

- **Low-temperature reactor design**
 - Conceptual designs include an unfired-boiler type reactor, with heat transfer oil flowing through pipes to heat the reactor
 - Some storage of hot oil would be possible for balancing reactors
 - Allows for easier sealing; no solar window needed
 - Receiver similar to LUZ – steel tubes with evacuated glass covers
 - Heliostats focused on receiver

Potential Solutions/Approaches (2)

- **High-temperature reactor design**
 - Direct insolation with window to maximize receiver efficiency
 - Secondary reflector to reduce aperture
 - Heat recuperation between low- and high-temp reactors

Potential Solutions/Approaches (3)

- **High-temperature reactor design**

- **Conceptual designs**

- Modified “bucket lift” with ceramic buckets & chain drive
- Rotating kiln with bulk solids heating
- Fluidized bed reactor using steam & ZnO-coated on alundum catalyst support supplied by Saint-Gobain NorPro (4-6 mm spheres)
- Spouted bed design (IMCC-US AEC)

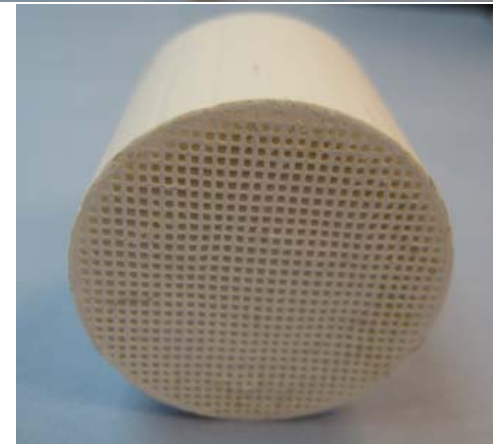

Solar Interface Options (1)

- **Cold Mirror Concept**

- North-field heliostats with full-spectrum reflectors
- Cold mirror near focus to redirect photonic flux down to two-sun photoreactor field South of tower

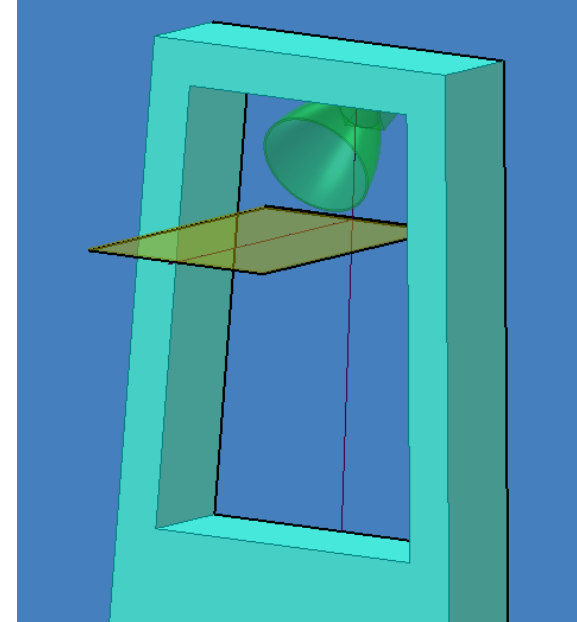
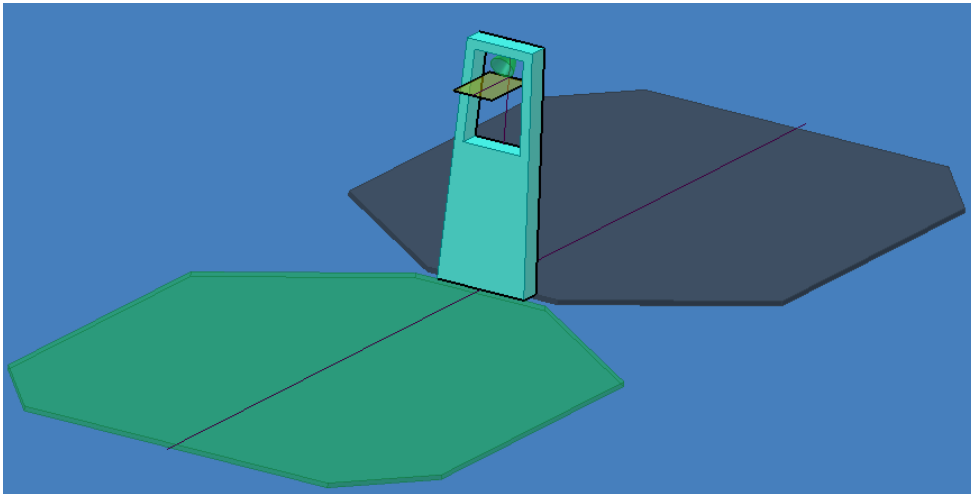

Solar Interface Options (2)

- Separate thermal receiver & photoreactor fields – *i.e.* dual field (DF)

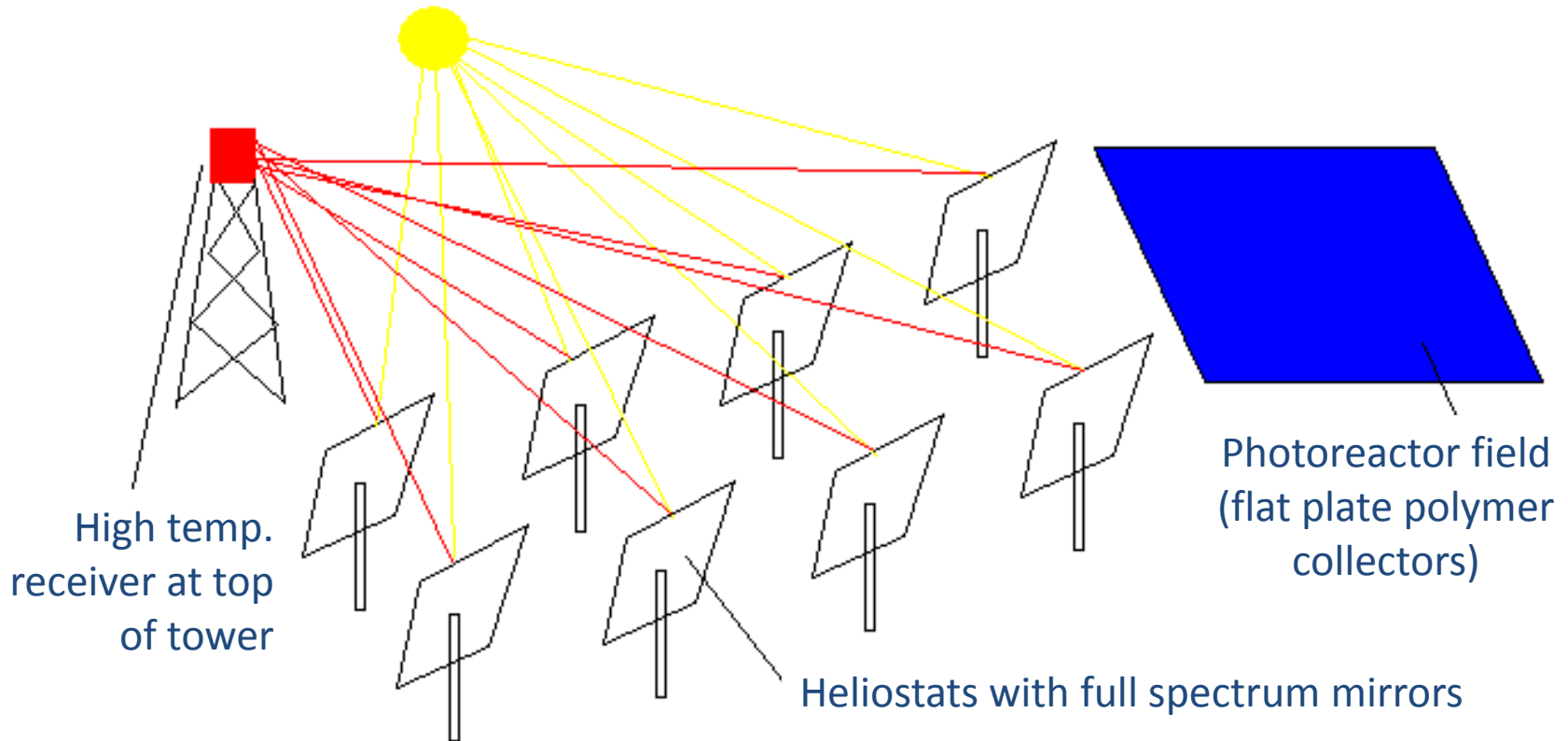

Solar Interface Challenges (1)

- **Beam Splitting (BS) Options**
 - Hot mirrors require large areas of mirror and liquid/gas distribution/collection system over entire heliostat field → costly
 - Cold mirror near receiver can be 500X smaller and can reflect to two-sun photoreactor field to South, increasing solar efficiency and decreasing photoreactor size
 - Separate one-sun photoreactor field and thermal field uses ~30% fewer heliostats but wastes some sunlight (low efficiency)

Solar Interface Challenges (2)

- **Solar Efficiency**

- Beam splitter gives higher overall solar efficiency, but requires ~30% larger heliostat field due to absorption losses and removal of UV/VIS energy from beam to thermal reactors
- Separate photoreactor field minimizes heliostat field size and simplifies systems but requires a large photoreactor field that “throws away” all but UV/VIS energy falling on it
- Heliostat field cost is the driving factor, favoring separate receivers for photocatalytic approach

Solar Interface Challenges (3)

- **Photoreactor Design**

- Low-cost “air mattress” design using PVDF (Kynar[®]) film for top surface
 - PVDF material has excellent UV transmittance in thin sheets
 - PVDF is tough and long-lived in outdoor exposure
 - PVDF is used extensively for outdoor exposure and for protection from UV damage (building facades, street coatings, etc.)

Solar Interface Challenges (4)

- **Process control of the thermal reactors is common to both the photocatalytic & electrolytic approaches**
 - **Reactors have different characteristics:**
 - Low-temp reactor operates at 500°C; NH_3 can be reacted immediately to eliminate storage
 - High-temperature reactor operating temperature $\sim 900^\circ\text{C}$; SO_2 production must be balanced with NH_3 from low-temperature reactor
 - **Storage as liquids is convenient & allows daylight-only operation of high-temperature reactors**
 - Avoids high-temperature storage
 - Direct absorption solar receivers are more efficient than storage/heat exchange

Solar Interface Challenges (5)

- **Process control approach**
 - High-temperature receiver paces operation
 - Intermediate temperature thermal storage and movement of heliostats between high- and low-temp receivers to achieve balance in outputs
 - Store 500°C heat in early AM and late PM when high-temp reactor cannot operate
 - Proportion heliostats and use storage during day to match outputs of reactors

Solar Interface Challenges (6)

- Example Reactor Configuration (Linkbelt)

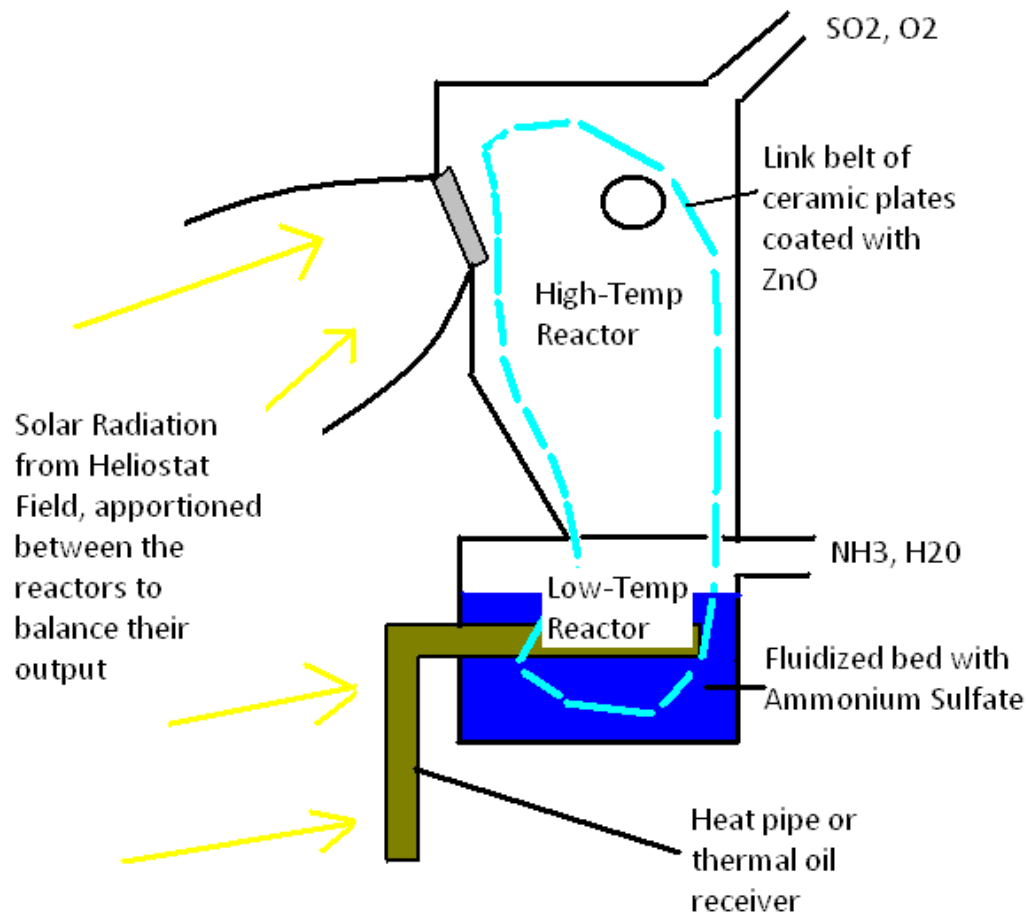

- Low thermal inertia
- Output balanced by moving heliostat aim points
- Minimal ZnO inventory
- Heat recuperation between reactors
- Simple control by belt speed, heliostat illumination

Heliostat Configuration

Photocatalytic system with cold mirror would use North-field heliostat configuration

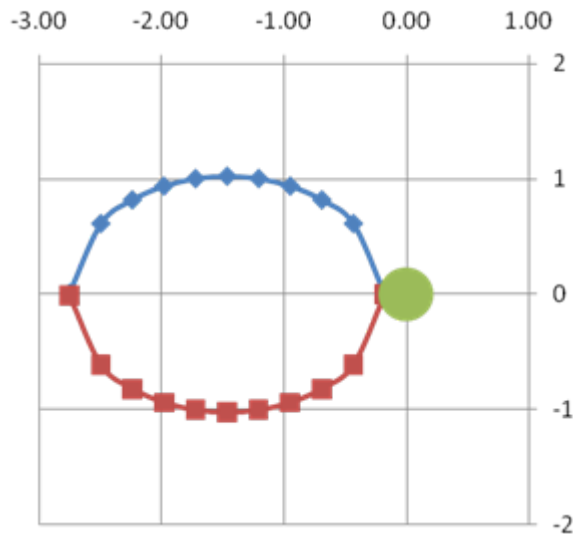

Heliostat effectiveness including cosine, attenuation, and shading from tower

View area on ground from receiver CPC with 40 deg outlook angle and 30 deg acceptance half-angle (dimensions in tower heights)

