

# **Oil-Free Centrifugal Hydrogen Compression Technology Demonstration**

Hooshang Heshmat, PhD

Mohawk Innovative Technology, Inc.

May 19, 2009

Project ID #  
PD\_34\_Heshmat

# Overview

## Timeline

- September 1, 2008
- Funding Authorized 2/28/09
- August 31, 2011
- 5 Percent Complete

## Budget

- Total project funding
  - \$2,992,416 DOE
  - \$1,149,253 MiTi®/MHI
- \$1,496,208 FY08/09 Funding
- \$1,496,208 FY10/11 Funding

## Barriers

- Hydrogen Delivery Compressor
  - Reliability
  - System Cost
  - Efficiency of H2 Gas Compression

## Partners

- Lead: Mohawk Innovative Technology, Inc. (MiTi®)
- Mitsubishi Heavy Industries

# Relevance

## Objective:

- **Demonstrate key technologies needed to develop reliable and cost effective centrifugal compressors for hydrogen transport & delivery**
  - **Flow 500,000 to 1,000,000 kg/day**
  - **Pressure rise to 300-500 psig**
  - **Contaminant-Free/Oil-Free Hydrogen**

Category	2005 Status	Project Target	
		FY2012	FY2017
Reliability	Low	Improved	High
Energy Efficiency	98%	98%	>98%
Capital Investment (\$M) (based on 200,000 kg of H <sub>2</sub> /day)	\$15	\$12	\$9
Maintenance (% of Total Capital Investment)	10%	7%	3%
Contamination	Varies by Design		None

# Relevance - Candidate Compressors

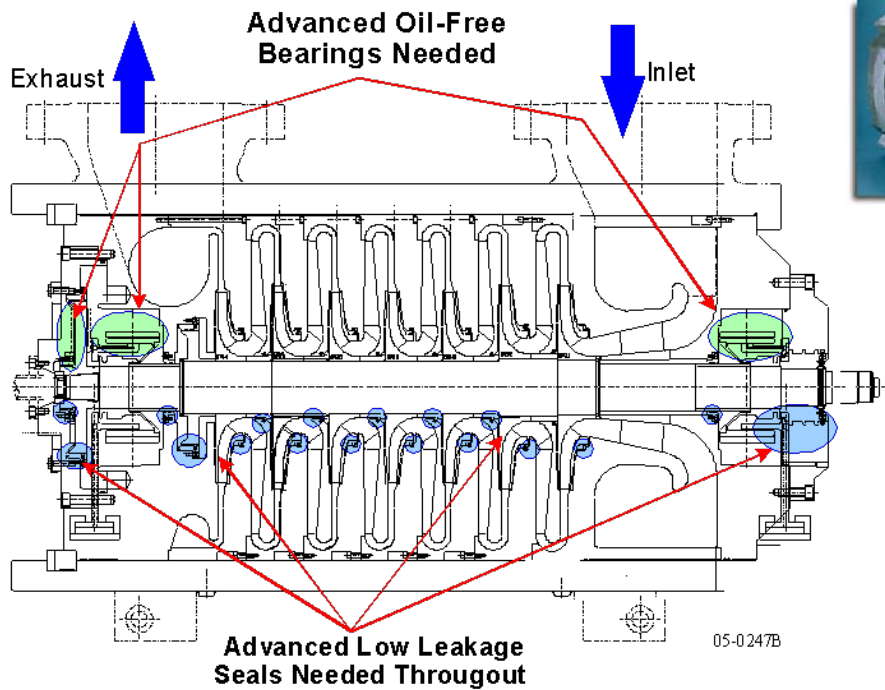

## Centrifugal Compressor

- One Moving Part
- High Reliability
- Minimal Contact/Sliding Parts
- High Efficiency and High Flow



## Piston Compressor

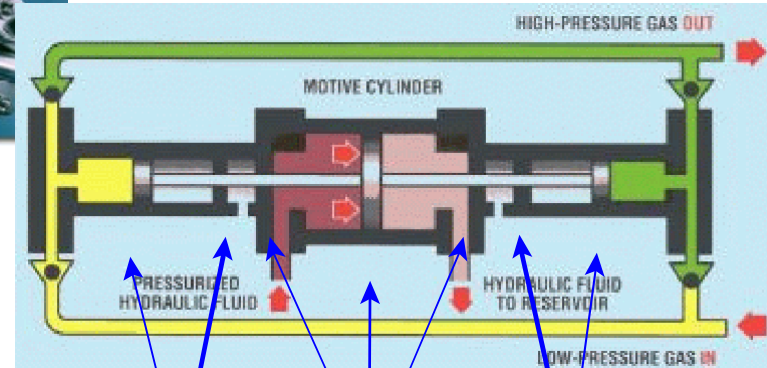

Sliding Contacts

## Guided Rotor Compressor

Sliding Face Seals

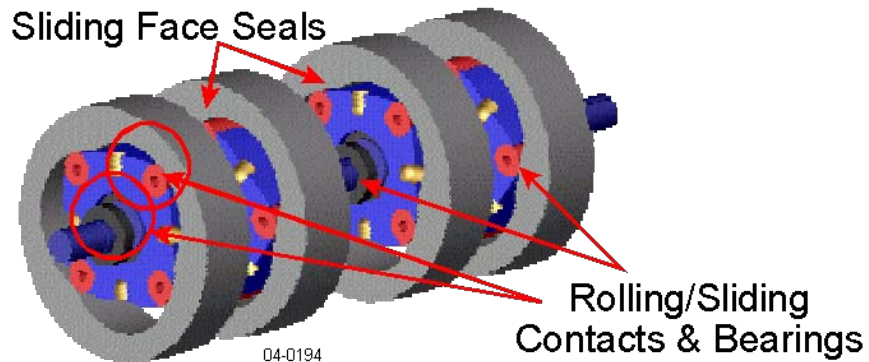

# Approach/Project Plan

- Review Design Requirements
  - 500,000 kg/day of H<sub>2</sub>
  - Output Pressure 1200-1500 Psig
  - 100-200 Mile Range
- Verify High-Speed Design
  - Double Entry Design
  - Seven Compressor Stages
  - Multiple Machine Frames
- Select Stage & Speed
- Size Bearings and Seals

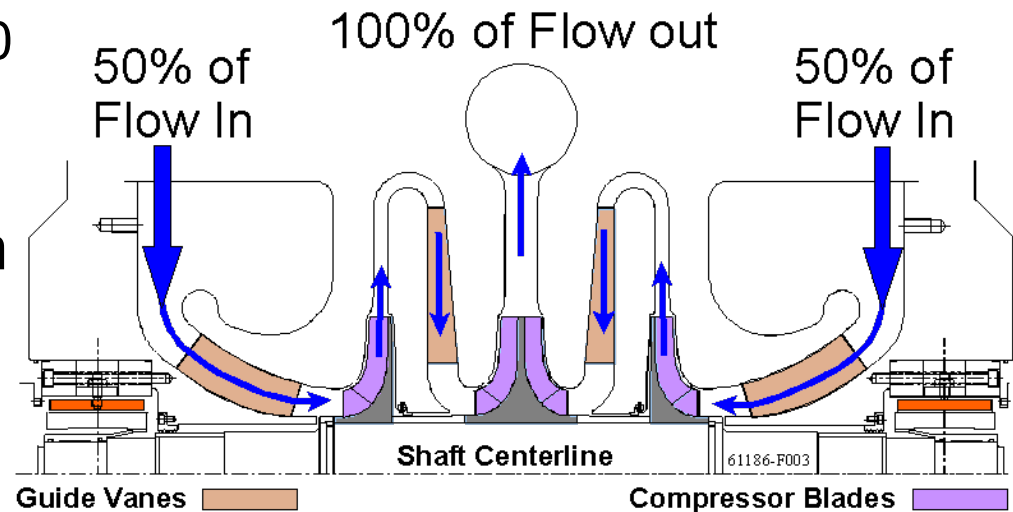

# Approach/Project Plan

- Design Single Centrifugal Compressor Stage
  - Inlet & Impeller
  - Diffuser & Return
  - Vane and Exhaust
- Compressor Design Analysis
  - Computational Fluid Dynamics
  - Finite Element Structural Analysis
- Oil-Free Bearings and Seals
- Fabricate and Test to Characterize Pressure & Flow
- Scale System Design
  - Use Test Data & CFD Analysis Results
  - Update Multi-Stage, Multi-Frame Compressor System Design
  - Predict Full Compressor System Performance

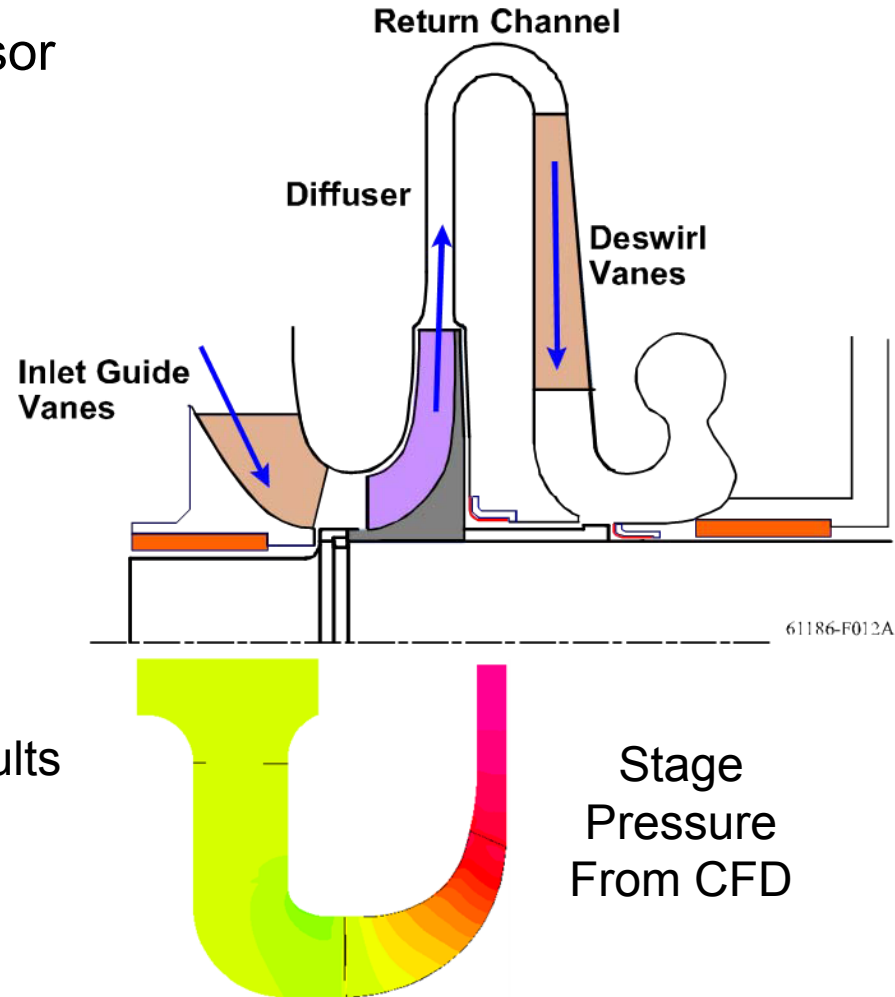

**Demonstrate feasibility of very high speed hydrogen centrifugal compressor through test .**

# Project Milestones

<b>Month/Year</b>	<b>Milestone or Go/No-Go Decision</b>
July-09	<b>Project Milestone:</b> Complete preliminary modular centrifugal compressor frame design to achieve pressure and flow. Select stage for detailed design, fabrication and test.
April-10	<b>Project Milestone:</b> Complete single stage compressor design including inlet, impeller, diffuser, return channel. Complete oil-free bearing and seal mechanical component system designs

**FY10 DOE Milestone:** Down select novel compression technology for hydrogen delivery.

Related SBIR Technical Accomplishments:

# Compressor Assessment

Compressor Type	Efficiency		Reliability	Costs		Contaminants
				Acquisition	O & M	
Piston	Low	Friction & Inertia	Low - Wear & Vibrations	High - Multiple Units	High - Overhauls, Outages, Efficiency	Yes - Oil
Guided Rotor	Low	Friction & Inertia	Low - Wear of Seals & Rollers	Medium -High	High - Efficiency, Bearing Life	Yes - Oil
Centrifugal	High		High	Medium	Low	No



# SSME Turbopump Configurations

Developed in the 1970's

## Liquid Hydrogen:

Series Design  
6,500 psig  
4,500 kg/min  
76,000 HP  
36,000 rpm

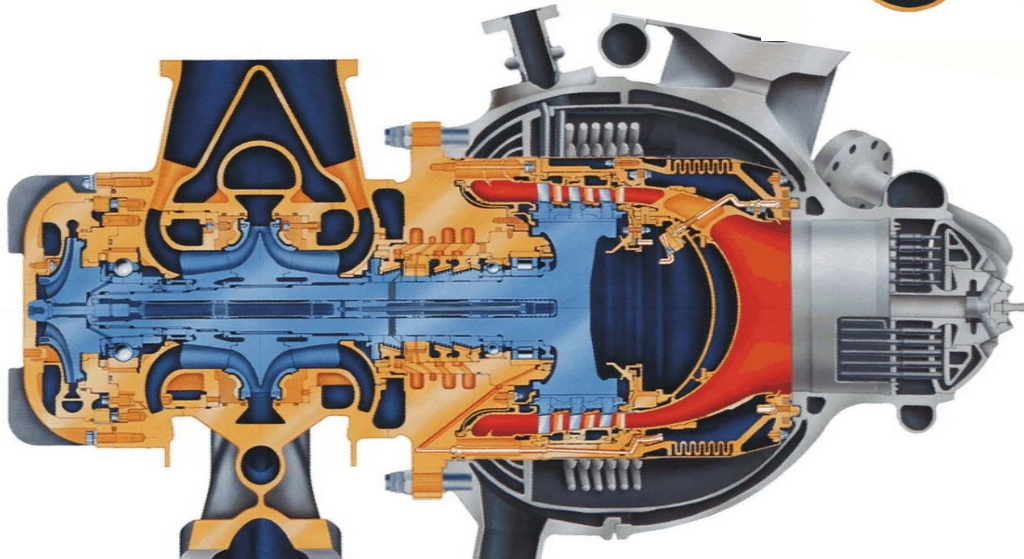
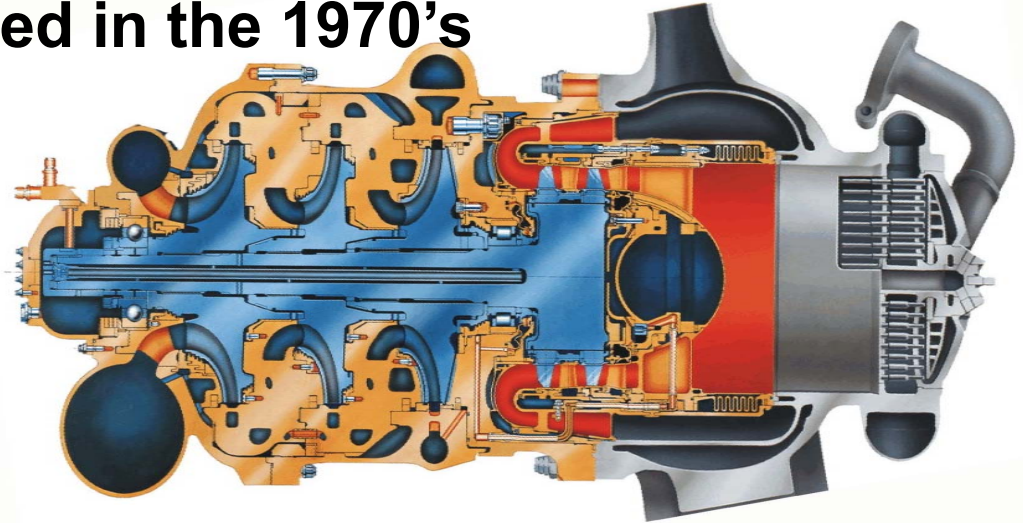

## Liquid Oxygen:

Double Flow Impeller  
7,500 Psig  
32,200 kg/min  
26,000 HP  
24,000 rpm

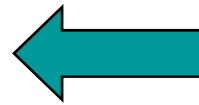

Plagued with Bearing Life Issues I.e., 10 Missions

Related SBIR Technical Accomplishments:

# Compressor Preliminary Design

Final Summary							
Maximum Head = 60,000 ft			Maximum Discharge Temp = 300F			Interstage Temperature = 200F	
Compressor Stage	Power (hp)	Pressure (psig)	Suction Flow (Cu-ft/min)	Speed (rpm)	Specific Diameter	Diameter (Inches)	Tip Speed (ft/sec)
<b>Inlet</b>		<b>500</b>	<b>3616</b>				
1	1626	573	3616		1.50	6.45	1521
2	1718	645	3400		1.56	6.42	1513
3	1814	727	3194		1.63	6.41	1511
<b>Outlet #1</b>	<b>5158</b>	<b>727</b>		<b>54000</b>			
<b>Inlet #2</b>		<b>712</b>					
4	1918	817	2960		1.55	5.92	1550
5	2028	922	2776		1.62	5.91	1548
<b>Outlet #2</b>	<b>3946</b>	<b>922</b>		<b>60000</b>			
<b>Inlet #3</b>		<b>912</b>					
6	2262	1054	2570		1.54	5.48	1578
7	2400	1200	2400		1.62	5.48	1578
<b>Outlet #3</b>	<b>4662</b>			<b>66000</b>			

# Progress

- **Previous Efforts Identified Centrifugal Compressor Configuration Feasibility and Technology Needs**
  - Internal MiTi® & MHI Company Funding
  - DOE SBIR
- **Preliminary Compressor Design Completed**
  - 500,000 Kg/day @ 1200 psig
  - Total No. of Stages Needed (7 Stages)
  - Impeller Diameters and Operating Speed Ranges Established (up to 66,000 rpm)
  - Total Driving Power < 14,000 HP

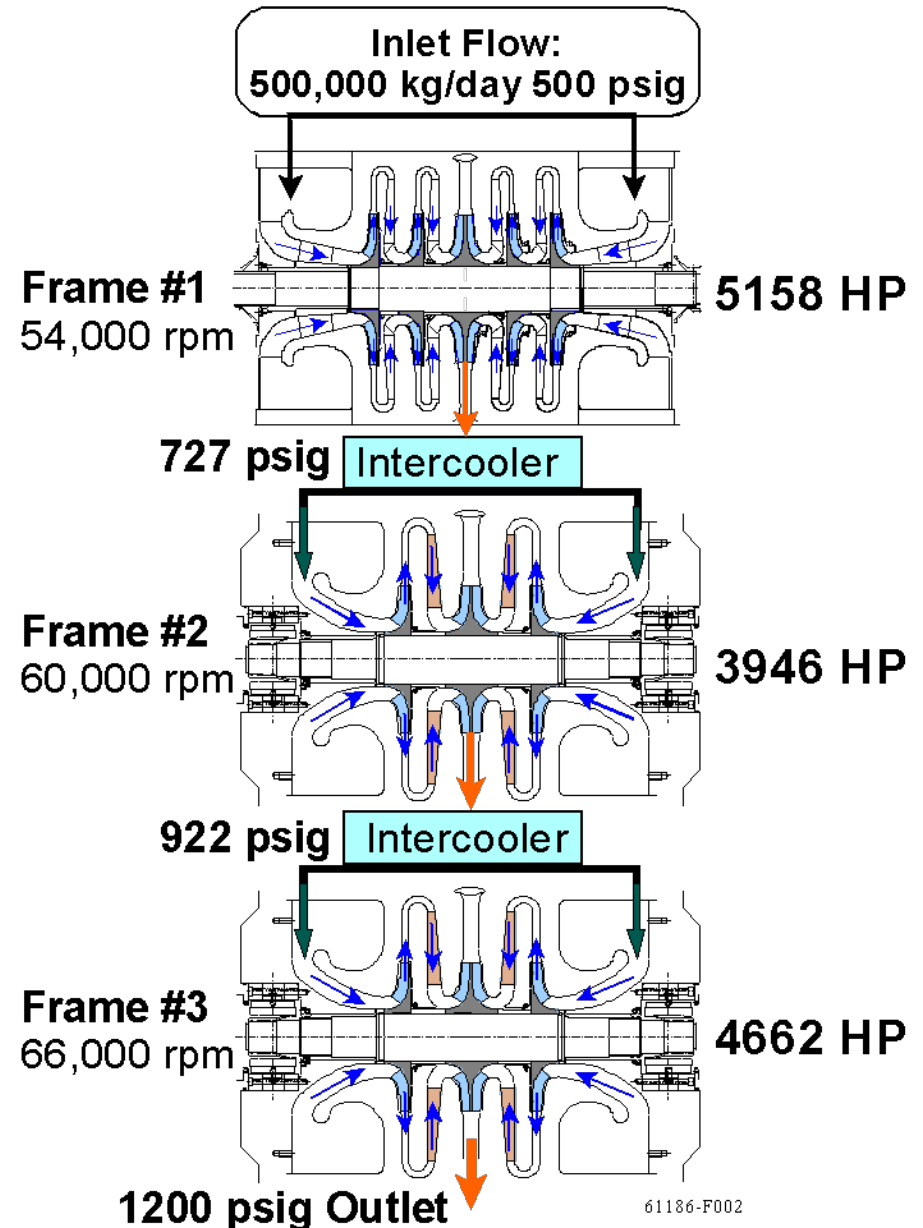

Related SBIR Technical Accomplishments:

# High-Speed Compressor Benefit

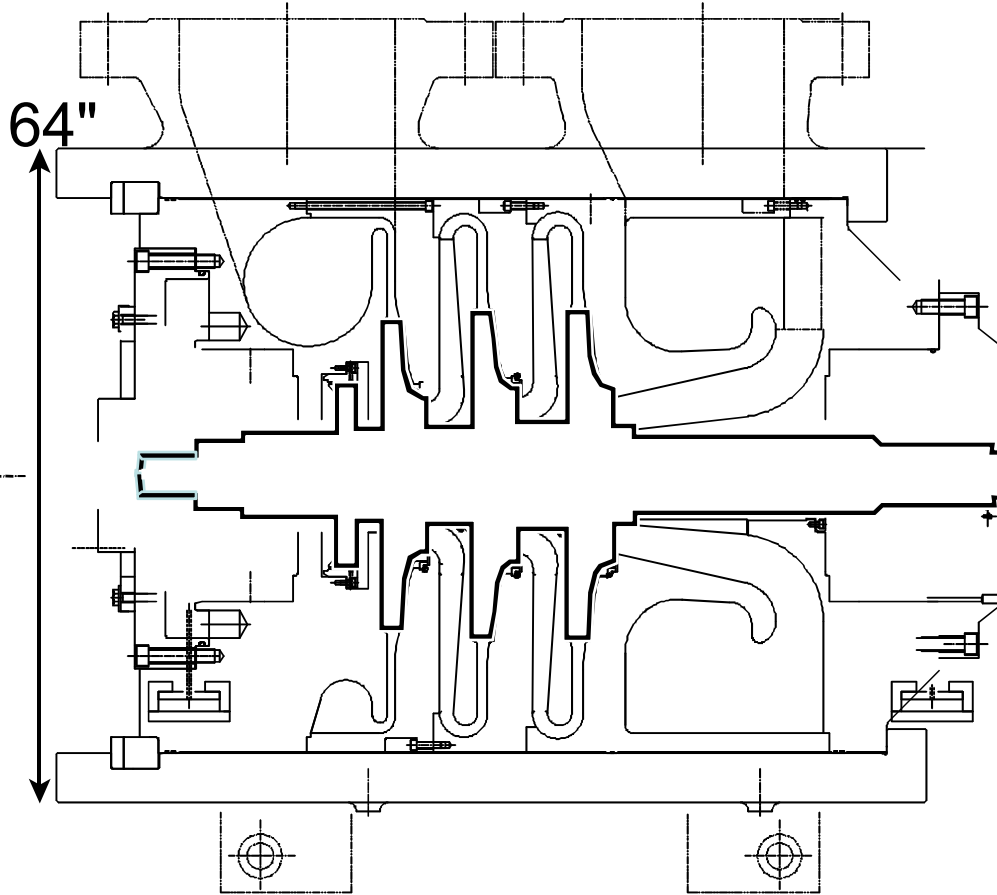

Machine Size Reduced  
More Than 4 Times

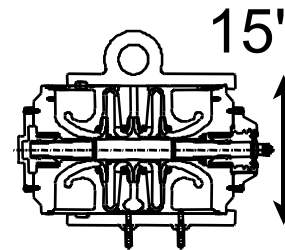

61168-F017

# Foil Bearings for H<sub>2</sub> Compressor

- Foil Bearings Sized
  - Journal Bearings
    - Diameter = 2.5" (63 mm)
    - Length = 2.0" (50 mm)
    - Projected Area = 5 in<sup>2</sup>
- Bearing Coating Selected
  - MiTi<sup>®</sup> Korolon<sup>™</sup> 900
  - 25 lb load capacity @ Start Up (N=0)
- Bearing Stiffness Designed
  - 20-30k lb/in/in
- Theoretical Load Capacity
  - 500 lb @ 800 fps



Related SBIR Technical Accomplishments:

# Dynamic Simulator Designed & Built

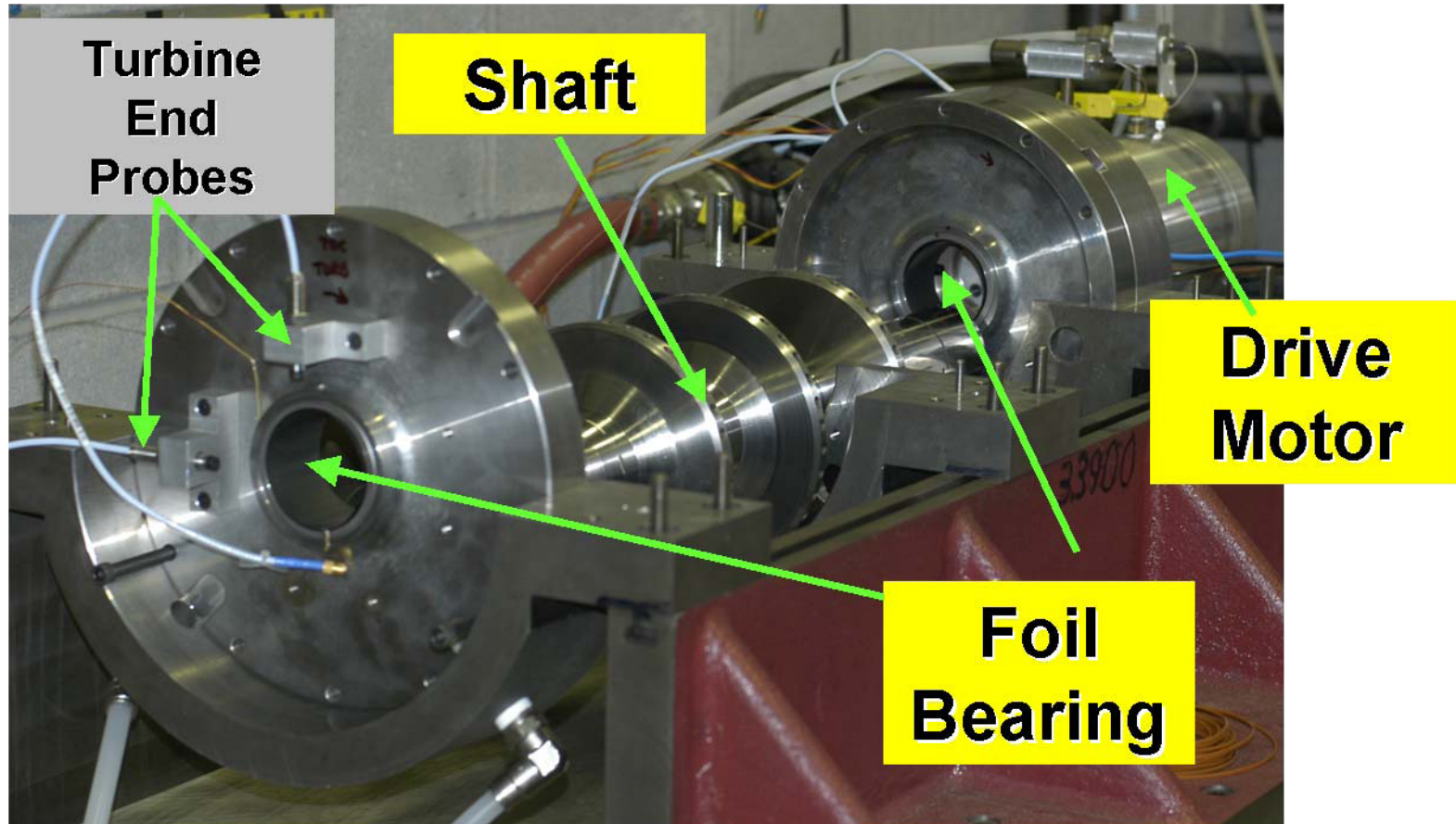

# Simulator FE Model

FEA rotor model analysis and experiment compared.

Configuration	1 <sup>st</sup> Bending Mode (krpm)	
	Measured	Predicted
Test Simulator Rotor System	31.80	31.80
Rotating Critical Speeds	34.35	34.32

❖ Correlation achieved within < 0.1%.

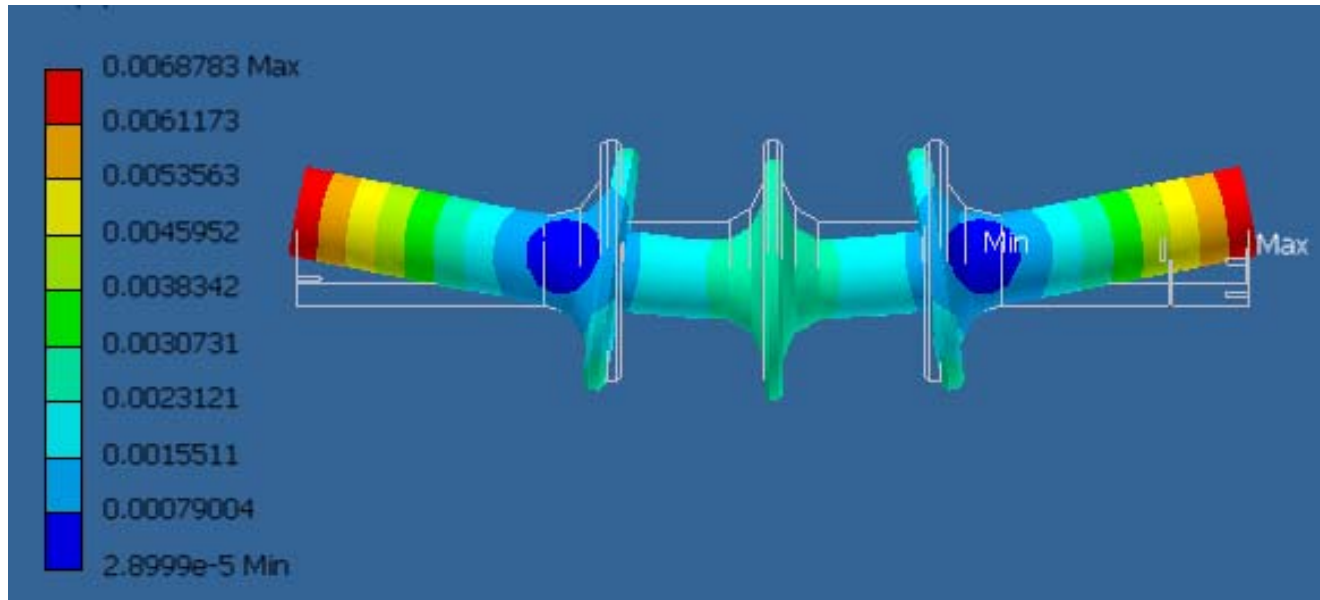

# Supercritical Operation

- ◆ Experimental plots of rotor run-up and coastdown through bending critical speed.

34,400 rpm run up

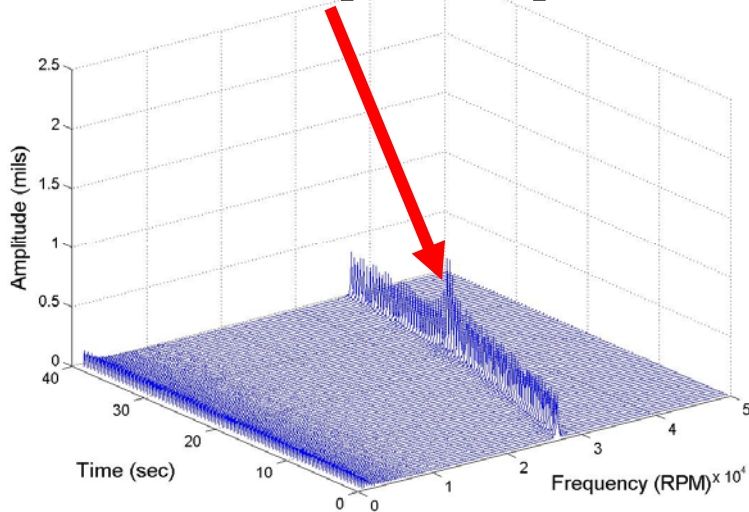

34,300 rpm coast down

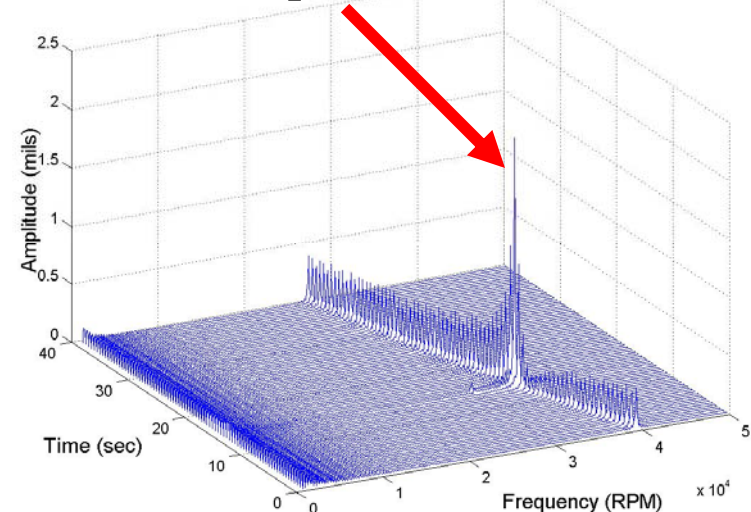

Drive End Vertical Sensor  
(X1V) – T3R21

- ❖ Excellent correlation with experimental results and system stable as expected



# Collaborations

- **Partner/Subcontractor**
  - **Mitsubishi Heavy Industries (Industry)**
    - **Centrifugal Compressor Stage Design**
      - CFD
      - FEA
    - **Single Stage Compressor Test**

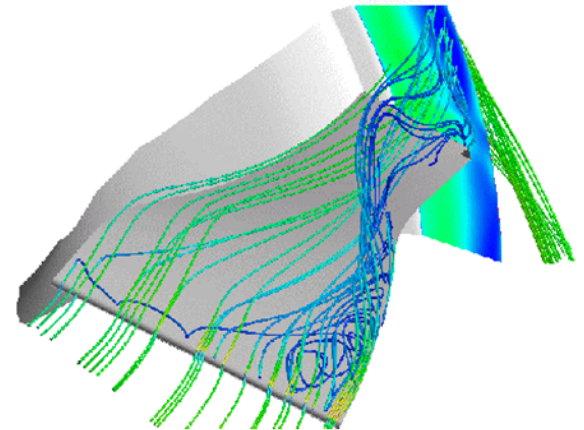

# Identified Technology Needs

- **Required High Speeds Dictate**
  - **Advanced Centrifugal Compressor Aerodynamic and Structural Design**
    - **High Stresses**
    - **Efficient and Effective Flow Path**
  - **High-Speed, Oil-Free Foil Bearings**
- **Hydrogen Requires**
  - **Novel Low Loss Seals**
  - **Low Friction and Long Wear Life Foil Bearing and Foil Seal Hydrogen Compatible Coatings**
  - **Hydrogen Compatible Materials**

# Future Work for FY09-FY10

- **Refine Multi-Stage/Multi-Frame Compressor Concept**
  - Establish Stage Pressure Ratios and Flows
  - Define and Select Optimum Operating Speeds
  - Select One Stage for Detailed Design and Test
- **Preliminary Design Review with DOE**
- **Conduct Detailed Design**
  - Establish Flow Path Including Inlet, Impeller, Diffuser and Return Channel Designs Using Established Design Analysis and Computational Fluid Dynamics
  - Design Foil Bearings and Seals Using Coupled Elasto-Hydrodynamic Analysis
  - Design Test Shafting Using Finite Element Rotor-Bearing System Analysis

# Project Summary

- **This project proposes to demonstrate that advanced and very high-speed, oil-free centrifugal compressors can meet hydrogen delivery needs**
- **MiT<sup>i</sup>® and MHI have shown analytically that multiple multi-stage very high speed centrifugal compressors operating in series are necessary and feasible.**
- **A key compressor stage will be designed, fabricated and tested to validate the concept and demonstrate overall system feasibility based upon advanced 3-D aerodynamic designs combined with oil-free compliant foil bearings and close clearance compliant foil seals**
- **Under this effort, compressor blade tip speeds, and bearing and seal surface velocities exceeding state-of-art will be designed, built and evaluated**

Hooshang Heshmat, PhD  
518 862-4290 x-12  
hheshmat@miti.cc

# Oil-Free Bearing Technology

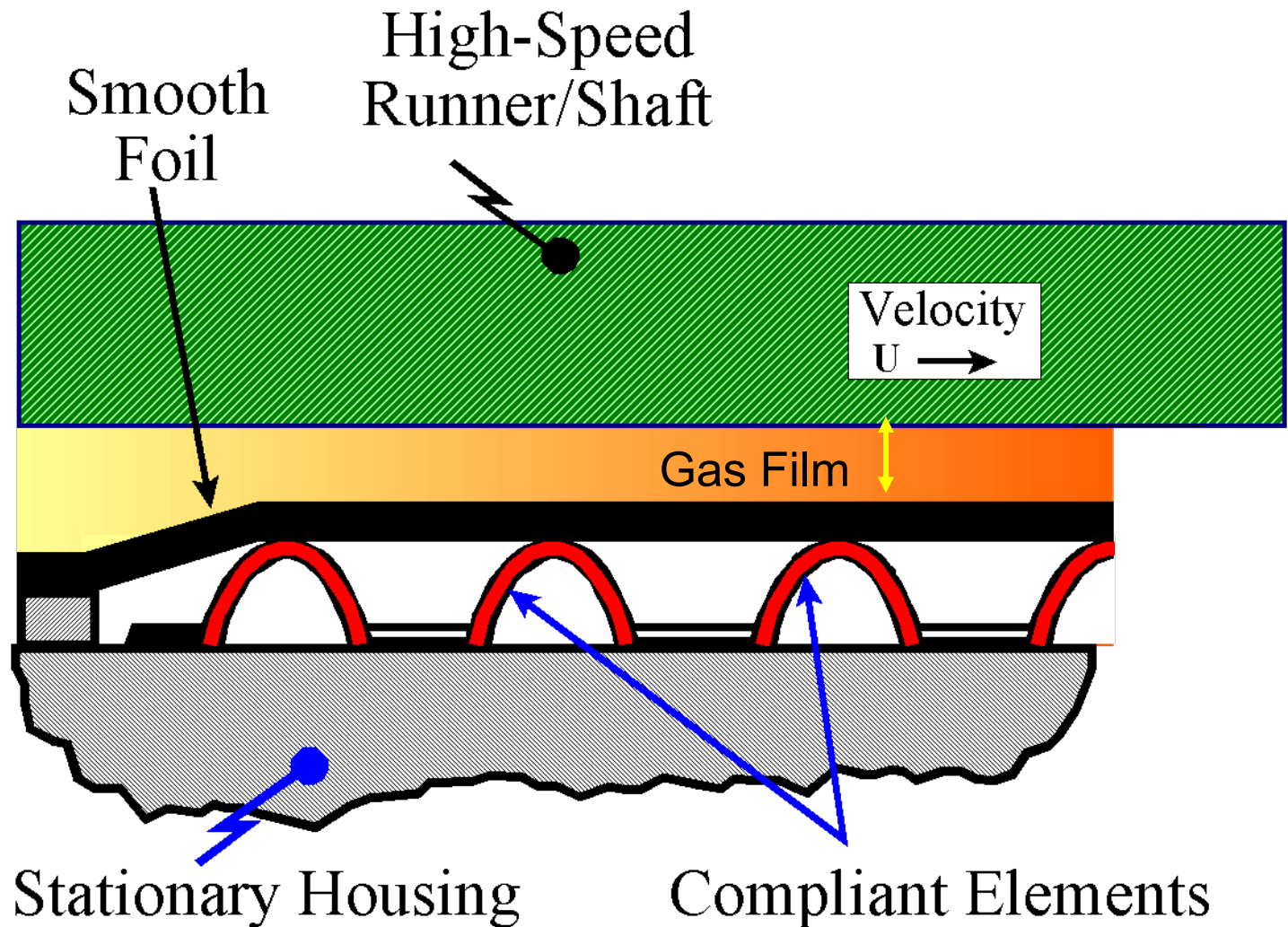

# Oil-Free Bearing Technology

## Velocity Profile

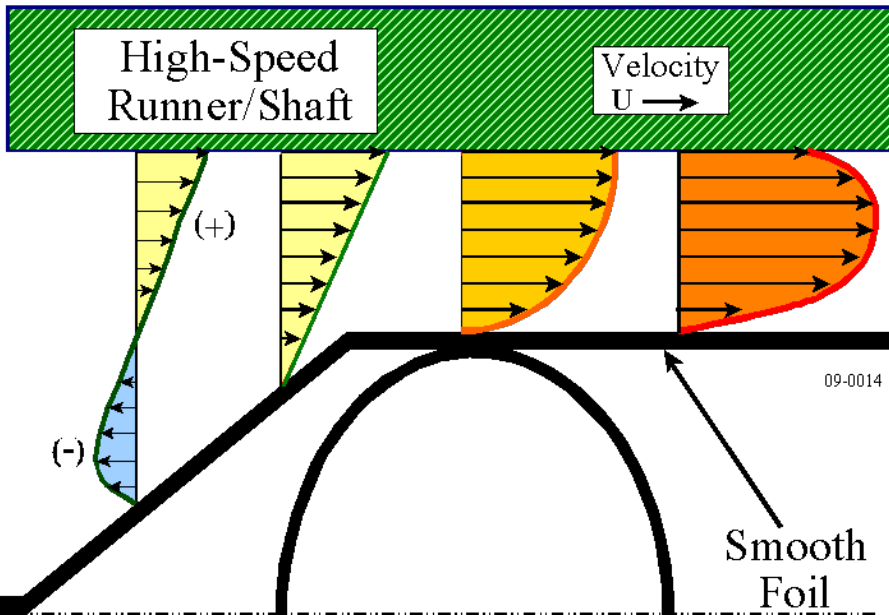

## Pressure Profile

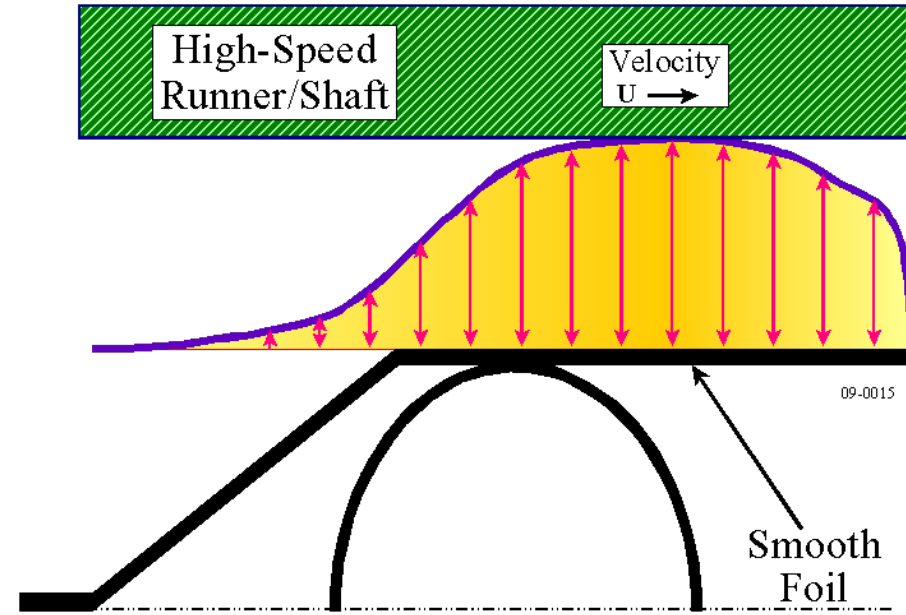

# Coupled Elasto-Hydrodynamic Seal Analysis

Patran 2008r1 (MD Enabled) 10-Mar-09 14:18:49  
Fringe: 1, A1, Incr=10, Time=1.00000, Displacement, Translation, Magnitude, (NON-LAYERED)  
Deform: 1, A1, Incr=10, Time=1.00000, Displacement, Translation,

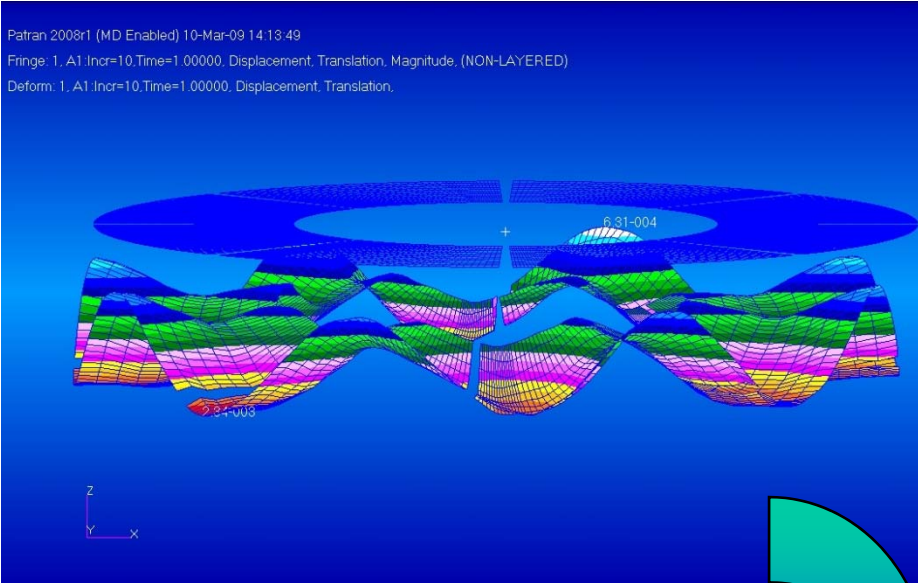

## Single Pad Pressure Profile

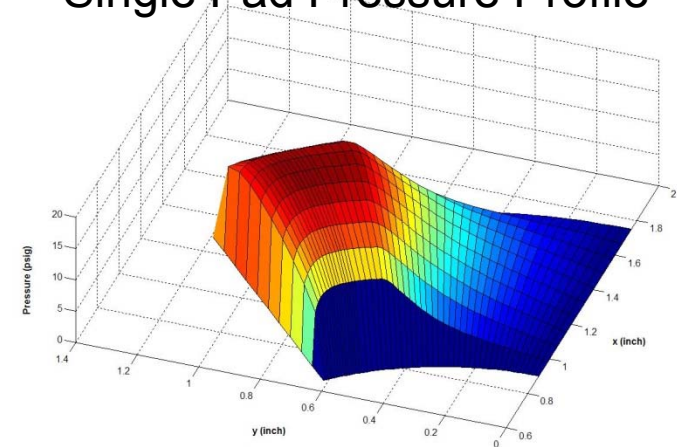

## Single Pad Stiffness Profile

