

# Reversible Liquid Carriers for an integrated Production, Storage and Delivery of Hydrogen

Bernie Toseland and Alan Cooper  
Air Products and Chemicals, Inc.

May 21, 2009

# pd\_38\_toseland

# Overview

## Timeline

- Start: Date 8/2005
- Team Kickoff 10/2008
- Project end March 2011
- 49% Complete

## Budget

- Total project \$4,131,138
  - DOE share (75%)
  - Contractor share (25%)
- Funding received in FY08: \$1,971,670
- Funding for FY09

## Barriers

- Barriers addressed
  - E. Solid and Liquid Carrier Transport
  - A. Hydrogen/Carrier and Infrastructure Options Analysis
  - F. Hydrogen Delivery Infrastructure Cost

## Partners

- Pacific Northwest National Laboratory/Battelle
- United Technologies Research Center (UTRC)
- BMW Group

# Approach

## PRODUCTION & DISTRIBUTION

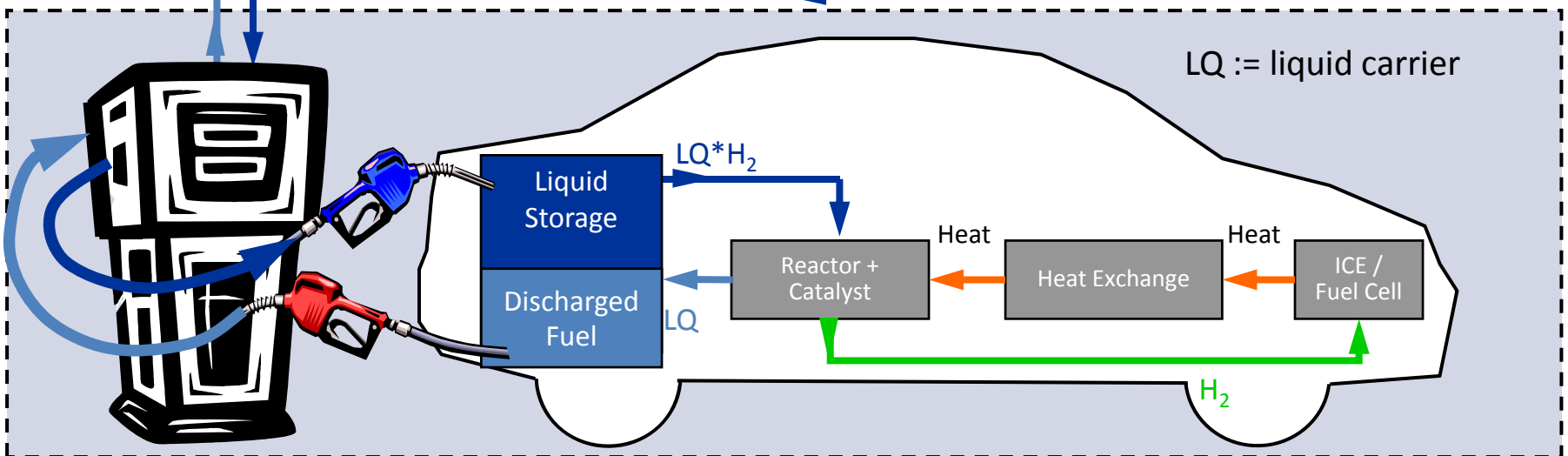
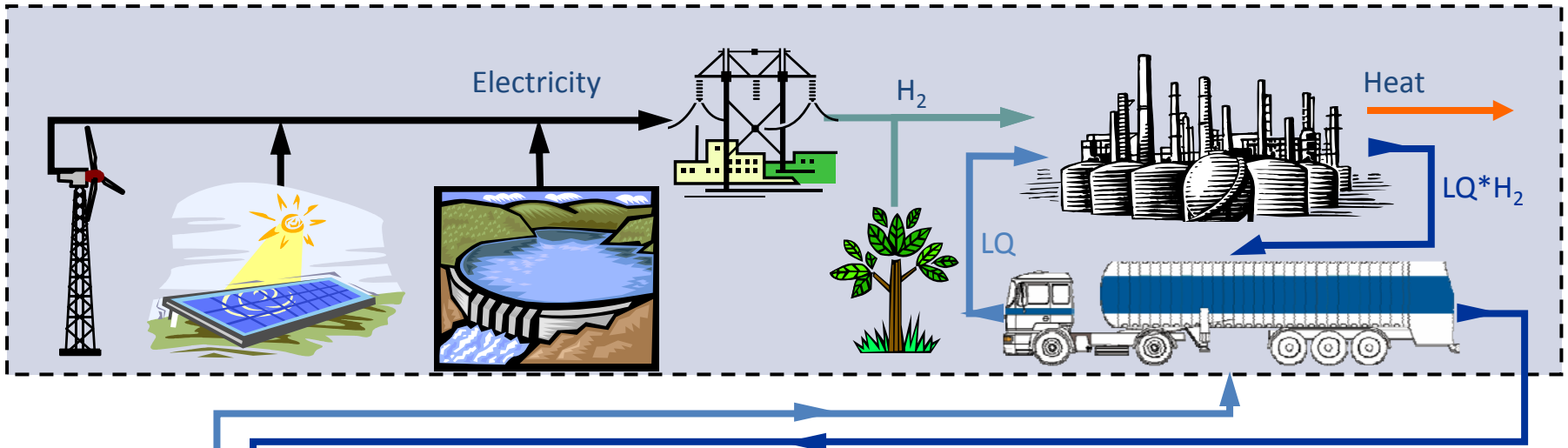

## REFUELING STATION

LQ := liquid carrier

# Specific Project Approach

- Mobile Reactor initial focus
  - Rationale: This is the most constrained challenge. Data gathered will be applicable to all delivery modes, FC, ICE and forecourt, since reaction heat will be supplied by high temperature fluid stream for all reactor types.
- N-Ethyl Carbazole, while not suitable for commercial use is suitable as a test fluid.
  - Model compound allows reactor characterization, and economic studies but is not final material.
  - Evaluate economic potential using N-ethylcarbazole as a model compound
- Modeling will be used to simulate, optimize and evaluate each mode of hydrogen delivery

# Collaboration

- BMW
  - Model integration of ICE and automobile
  - Testing prototypes
    - Evaluate performance
    - Provide operational parameters
- UTRC
  - Model integration of FC and reactor.
    - Forecourt
    - Automobile
- PNNL
  - Design of microreactors
  - Fabrication of prototype(s)
- AP
  - Testing of single microchannel reactors and packing for forecourt reactors
  - Providing materials
  - Testing prototypes (ICE)
  - Project Coordination

# Technical Accomplishments

## Microchannel Reactor Results

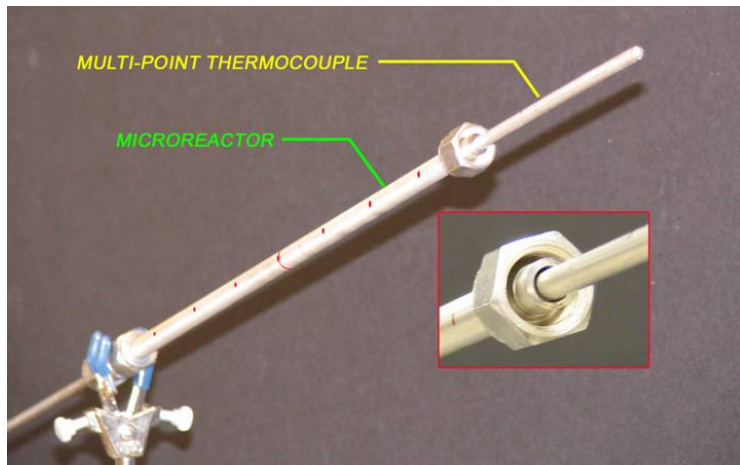

Typical Results 250°C

Catalyst	Feed Rate (ml/min.)	H <sub>2</sub> Flow (sccm)	Conversion (% available H <sub>2</sub> )
Pt	0.1	52	80
	0.4	193	74
	1	421	65
Pd	0.1	23	35
	0.4	50	20
	1	75	12
Pd (particles)	0.1	59	91
	1	458	71

Single-tube microchannel reactors performed well

- Stable catalyst coating method was established.
- Reactor diameters from 2.55-0.5mm were demonstrated. (5 mm for particles)
- Single-pass conversions as high as 90% achieved.
- Temperatures from 190-250°C were achieved.

# Efficiencies of Microchannel Reactors

Pd Catalyst microchannel Reactor shows low catalyst efficiency and little effect of reactor length.

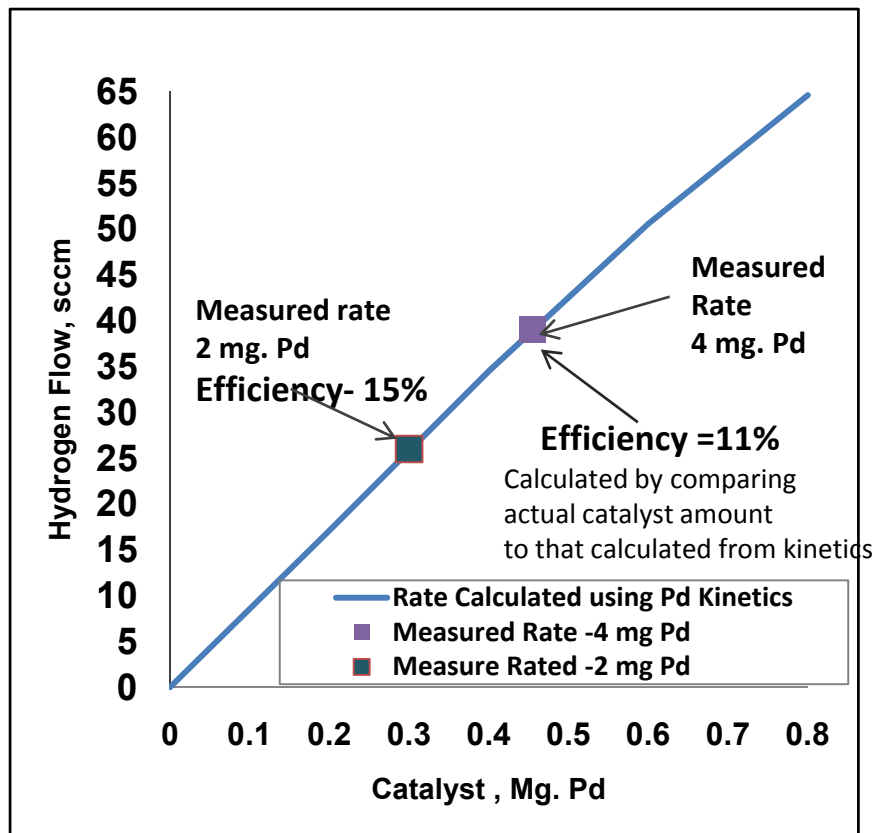

Pt Catalyst microchannel Reactor shows low catalyst efficiency and little effect of reactor length.

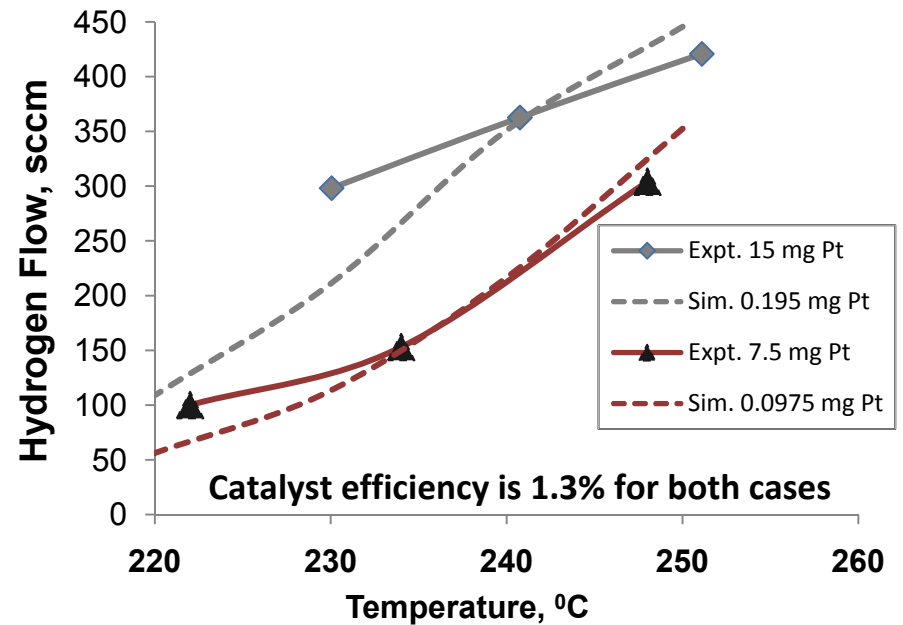

What is Primary cause of low efficiency?

# Kinetics Modeling

- Dehydrogenation modeled adequately as three reactions in series.
- Batch experiments using slurry catalyst (small particles to eliminate mass transfer resistances) used for primary data.
- Activity of other catalyst forms done on the basis of the weight of the metal. (We expect some reduced efficiency when used in a thin film (typically 50% reduction based on APCI monolith experience))
- Kinetic expressions used in process models and to evaluate reactor performance or strategy. E.g., for Pd takes 40% more metal to go from 90 to 95 % conversion.

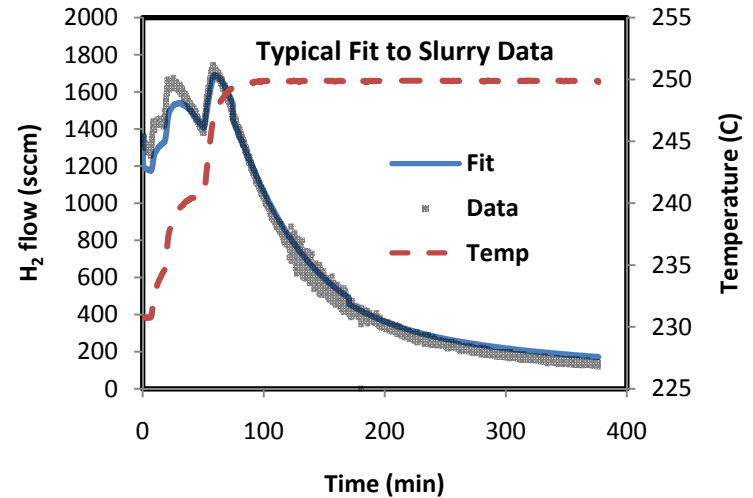

**Pd vs. Pt**  
250°C and 0.25 ml/min.

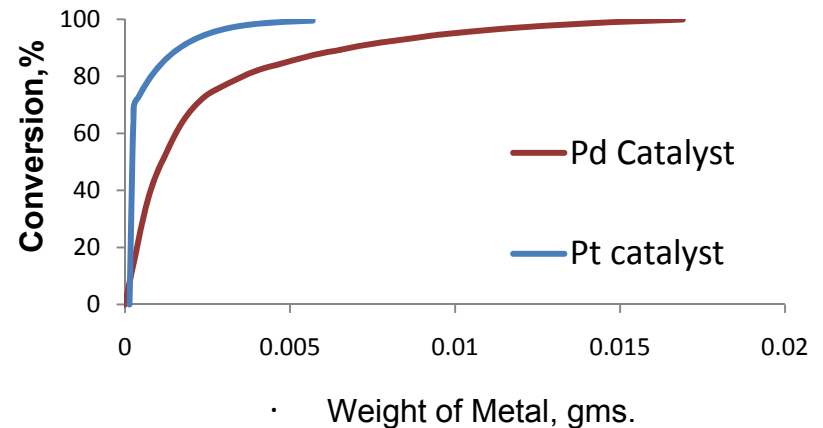



# Technical Accomplishment

## CFD analysis of microchannel reactor flow

### Re-analysis of tubular flow pattern in microchannel

N-ethylcarbazole conc.

max = 0.01

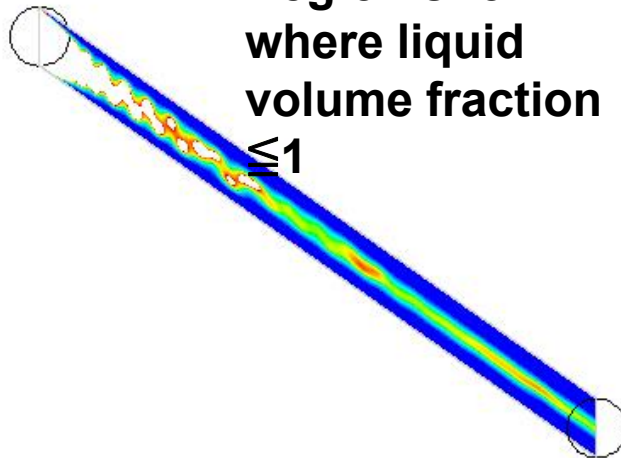
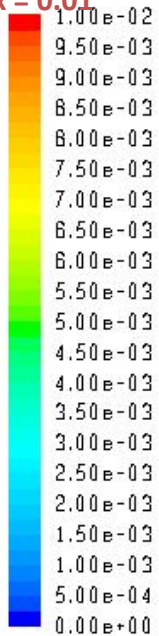

Region shown where liquid volume fraction  $\leq 1$

Increased calculation precision shows liquid breaks up into droplets

### CFD Analysis of Liquid Distribution in Annular Microchannel Reactor

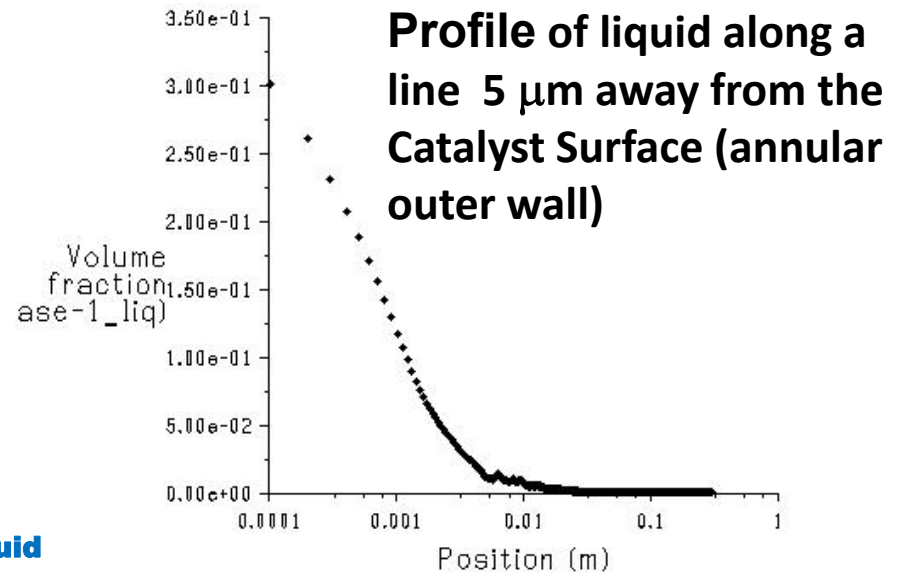

Liquid Volume Fraction at catalyst surface decrease dramatically along Tube Length

N-ethylcarbazole conc.

min= 0.0

**Conclusion: Extremely low amount of liquid at Catalyst Surface limits catalyst efficiency**

# Microchannel Dehydrogenation Reactor

## Technical Approach

- Address the issue of low liquid volume at catalyst surface by :
  - Segregating gas from liquid within the reactor
  - Keeping the catalyst wet and increasing liquid residence time
- Improve heat transfer to support endothermic reaction
  - Using laminate architecture
- Scale-up by numbering up channels

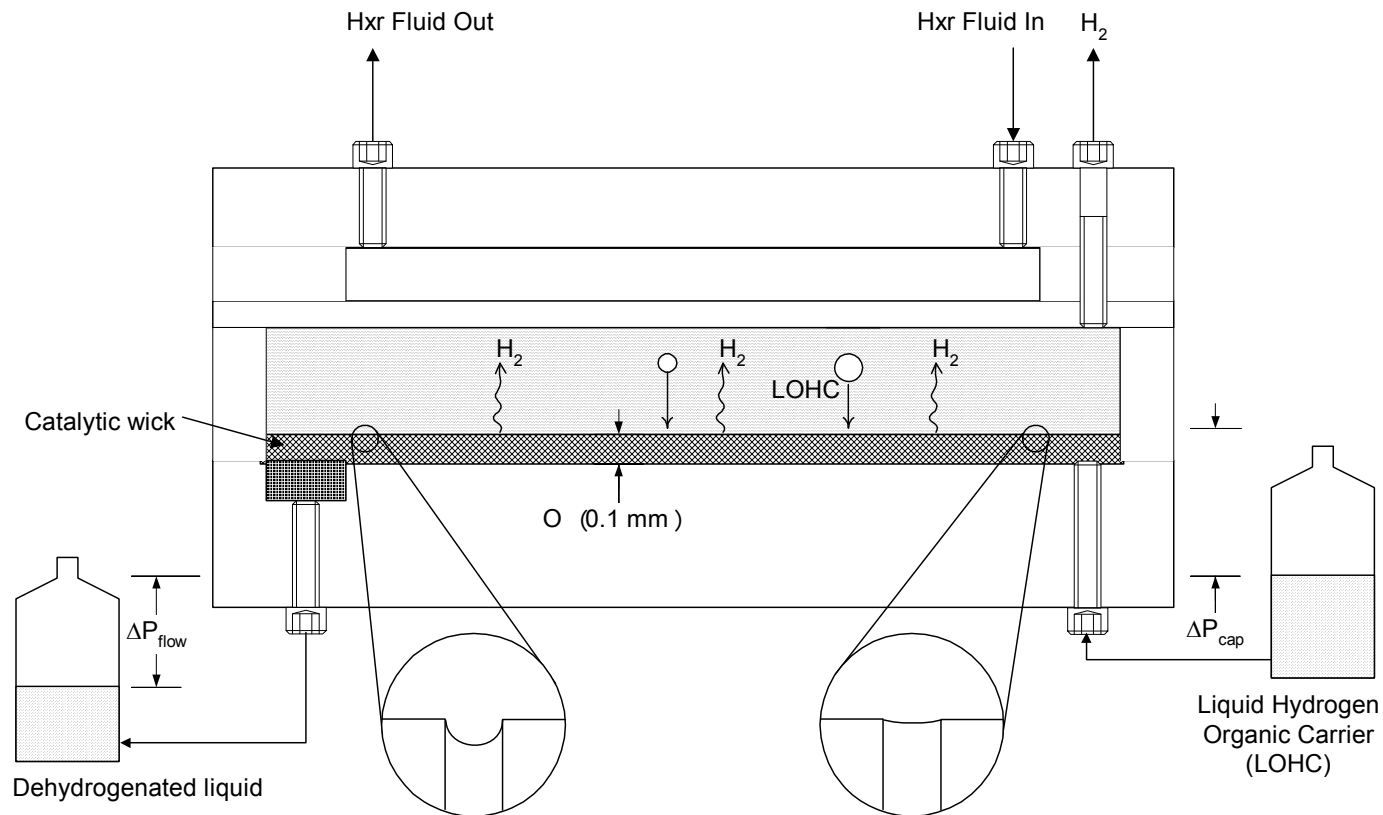

# Microchannel Dehydrogenation Reactor

## Technical Progress and Path Forward

- Single Channel Microwick Reactor
  - Approx. 5 cm x 6 cm footprint
  - 1-3 mm deep
  - Sapphire window to observe phase segregation
  - Heated with microchannels from below
  - Targets
    - 1 mg Pt/cm<sup>2</sup>
    - ~60 W<sub>e</sub> equivalent power (0.06 g H<sub>2</sub>/min)
- Initial results
  - Excellent gas-liquid separation at room temperature
  - Discovered unexpected phenomena at > 100°C
    - 'Free liquid' forms stable liquid droplets
    - Liquid droplets become entrained in gas flow
    - Reduces wicking flow capacity
  - 17% target catalyst loading
  - 2% H<sub>2</sub> productivity

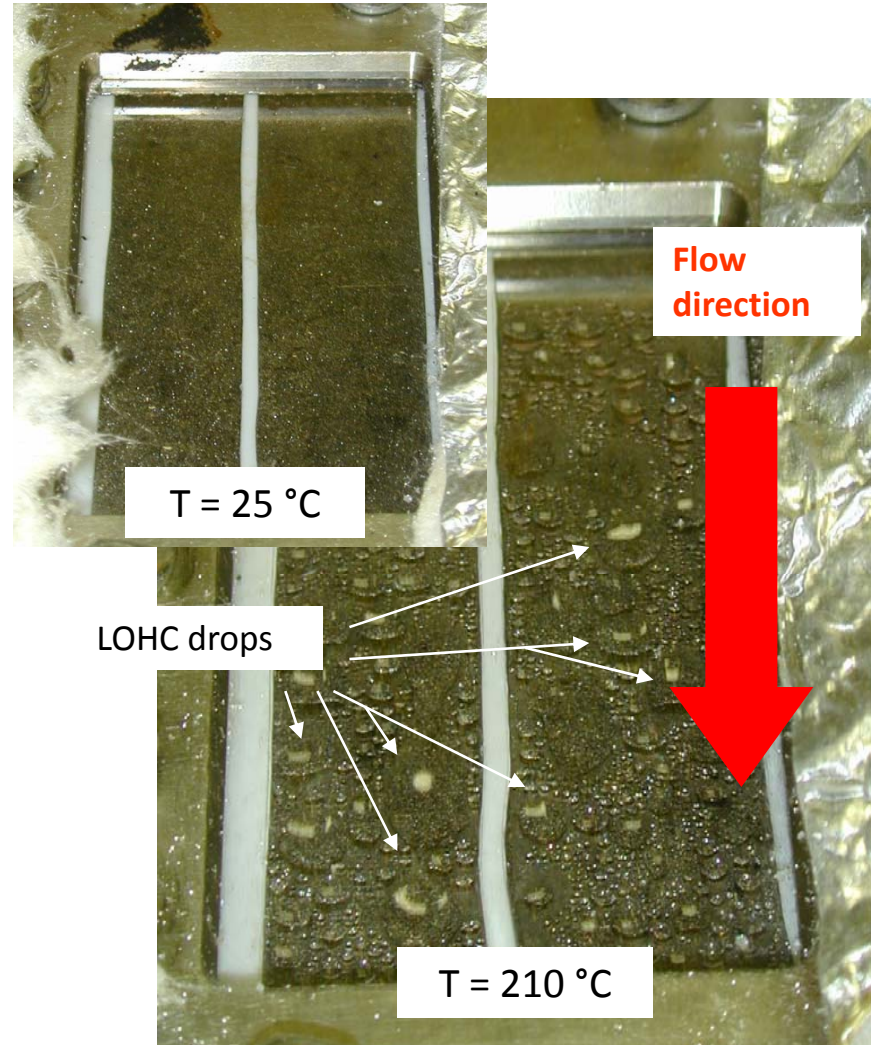

Single channel catalytic wick

# Technical Accomplishments

## Integration ICE and Liquid Carriers

Combining operating characteristics of ICE  
e.g. Exhaust gas conditions

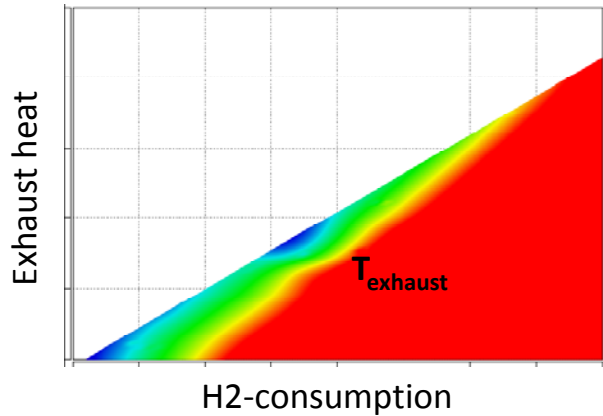

Performance Requirements  
e.g. Transient Run-up of Reactor

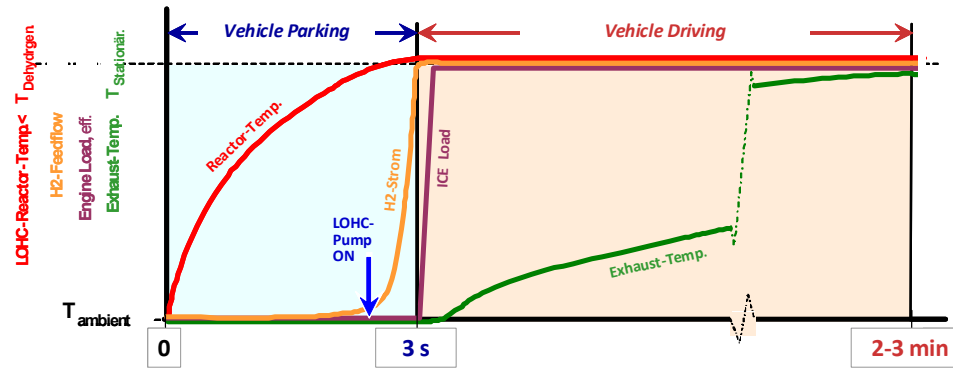

LOHC-System  
System Objectives

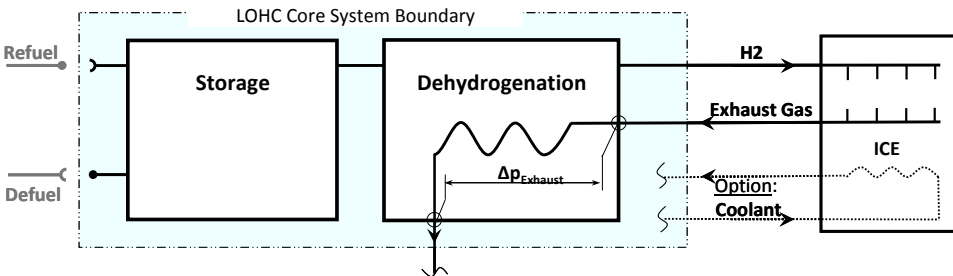

Steady-State Operation of Reactor  
 $T_{\text{Dehydrogenation}}$  vs.  $\Delta H$

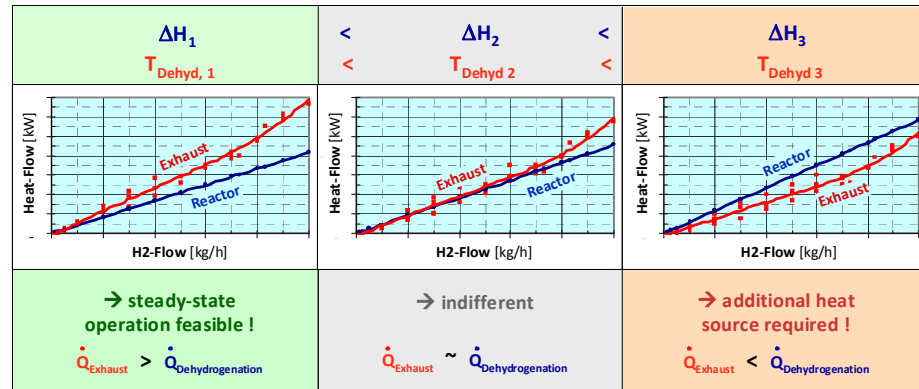

Initial modeling has defined feasible operating points depending upon characteristic of liquid carriers

# Tech Accomplishments/Relevance

## Estimation of full-size core reactor:

- Target: 10 kg H<sub>2</sub>/h , 60 kW thermal
- Heat transfer limiting reactor size
  - Current reaction rate (no mass transfer issues) support this
  - Case 1: Demonstrated in commercial-ready devices
  - Case 2: Laboratory demonstrated

Heat transfer limit		Heat Exchange Area Reactor Volume		Demonstrated		Laboratory	
				500	[m <sup>2</sup> / m <sup>3</sup> ]	1000	[m <sup>2</sup> / m <sup>3</sup> ]
				60	[kW]	60	[kW]
Gas heated	Reactor Volume			2,8	[l]	1,4	[l]
	Heat Exchange Area			1,4	[m <sup>2</sup> ]	1,4	[m <sup>2</sup> ]
	Reactor Mass			11	[kg]	6	[kg]
Oil heated	Reactor Volume			0,5	[l]	0,2	[l]
	Heat Exchange Area			0,24	[m <sup>2</sup> ]	0,24	[m <sup>2</sup> ]
	Reactor Mass			2	[kg]	1	[kg]

## Conclusion:

Reactor size estimations should be suitable for use in automobile

Leveraging UTRC Fuel Cell modeling (gPROMS), system models are being constructed to evaluate on-board performance and apply waste heat sources to drive the dehydrogenation process at the forecourt.



- On-board
  - Extend Argonne National Lab on-board analysis: modify configuration, incorporate PNNL reactor performance, conduct trade-off studies (weight, volume, kinetics, efficiency).
  
- Forecourt baseline configuration
  - Burn  $H_2$  for dehydrogenation process

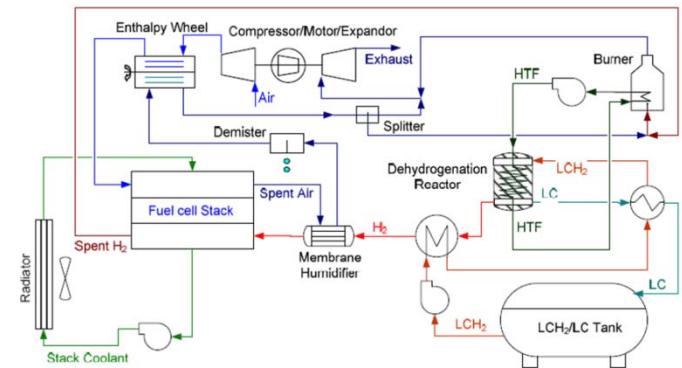

“System Level Analysis of Hydrogen Storage Options”, Ahluwalia, R.K. et al., 2007 DOE H<sub>2</sub> Program Review, May 2007.

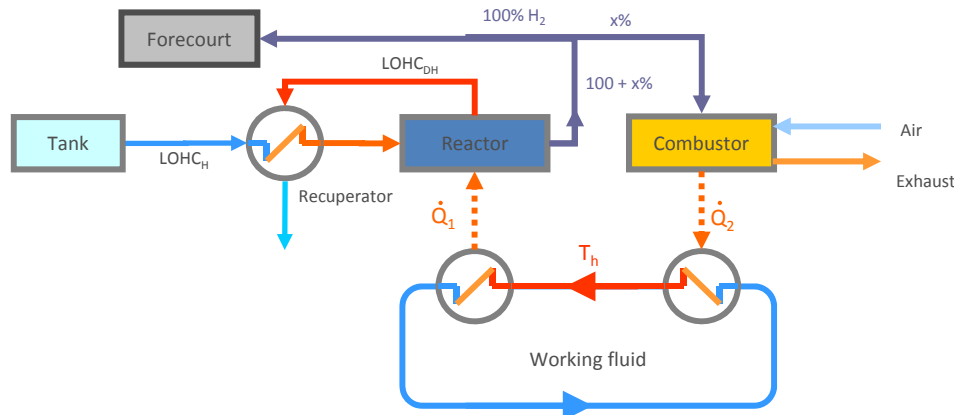

- Reactor kinetics
  - Air Products model incorporated into UTRC gPROMS models

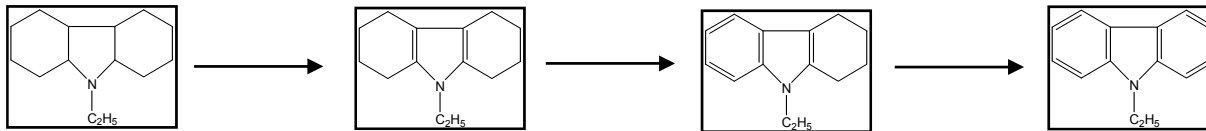

Implementation  
validated

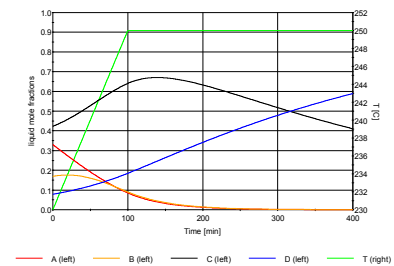
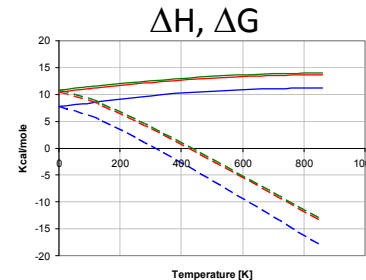
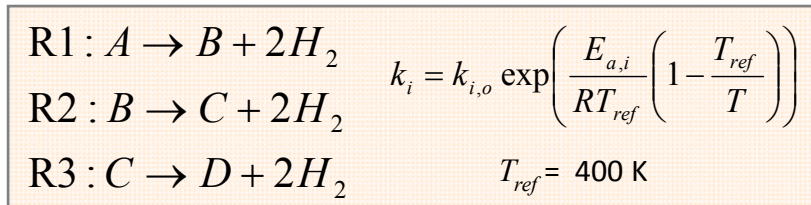

- Forecourt modeling: Several system configurations for hydrogen generation using the liquid carrier are being modeled leveraging existing models to improve heat utilization efficiency for the overall plant.

# Summary

- Microchannel reactors
  - Dehydrogenation successful over a variety of conditions
  - Low catalyst efficiency was traced to the high gas flow rate.
  - Experimental work to separate gas flow and increase liquid contact is underway.
- Modeling
  - Forecourt/FC: We have begun building system models
    - to evaluate on-board performance and
    - the dehydrogenation process at the forecourt.
  - Initial modeling of ICE
    - determined that the reactor size should be feasible for an automobile
    - defined stable operating point depending upon the characteristics of the carrier fluid



# Project Overview

- Reactor Testing
  - Test novel catalyst forms (foams) for forecourt reactor
  - Improve the gas-liquid separation in a Microwick Reactor
- Modeling
  - Incorporate reactor models into Fuel Cell/ Forecourt Modeling and perform trade-off analysis
  - Continue high-level system evaluation for ICE by adding necessary components with the goal of evaluating dynamic system characteristics
- Supply
  - Provide hydrogenated feed for all partners
  - Scale up hydrogenation process

# Future Work – Microchannel Reactor Development Milestones

