



# High Permeability Ternary Palladium Alloy Membranes with Improved Sulfur and Halide Tolerance:

DE-FC26-07NT43056

Kent Coulter, Ph.D.  
Southwest Research Institute®

May 22, 2009

Project ID # PD\_47\_Coulter



# Objectives

**Overall DOE Goal:** Develop technologies that effectively and economically separate hydrogen from mixed gas streams that would be produced by coal gasification

**Objective:** To utilize an iterative modeling, rapid fabrication, and testing approach to develop and demonstrate an ultra-thin durable ternary Pd-alloy membrane with excellent resistance to sulfur and halogen attack.

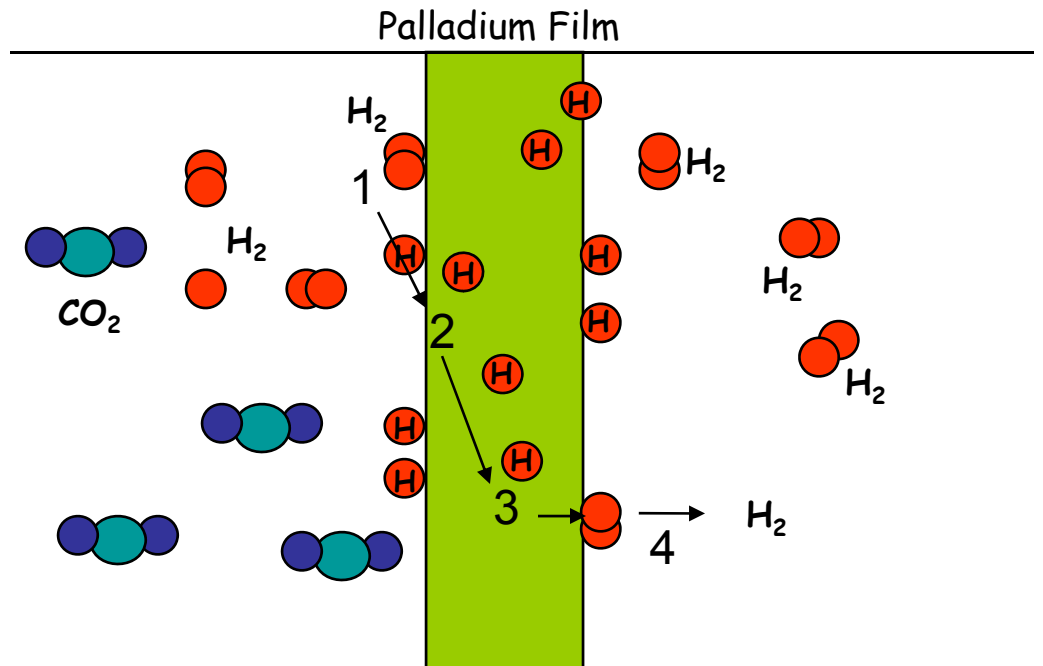

What alloys can be used to maximize H<sub>2</sub> flux and/or maximize stability and/or minimize cost ??



# Overview

## Timeline

- Project start: May 02, 2007
- Project end: May 01, 2010
- Percent complete: 60%

## Budget

- Total project funding
  - DOE share: \$1,199,049
  - Contractor share: \$299,763
- Years 1&2
  - DOE share: \$759,996
  - Contractor share: \$190,000

## Barriers

- Barriers addressed
  - G. Hydrogen Embrittlement
  - I. Poisoning of Surfaces
  - Q. Impurities in Hydrogen

### Scope of Work

- 1) Materials modelling and composition selection:
- 2) Fabrication of ternary alloy membranes:
- 3) Membrane testing and evaluation:



# Collaborators



**Miguel Esquivel,**  
Surface Engineering & Materials Chemistry



**David Sholl, Chen Ling, Lymarie Semidey-Flecha**  
Chemical Engineering and Materials Science



**J. Douglas Way, Abbie Gade**  
Chemical Engineering Department,



**Bill Pledger**



**Gohkan Alptekin, Bob Amalfitano**



DOE Hydrogen Program

**Rick Dunst**



# Milestones

## Phase I (Year 1)

- *Milestone 1.1:* Use DFT methods to predict  $H_2$  flux through  $Pd_{96}M_4$  for  $M = Ni, Rh, Pt, Nb, Ta, V, Mg$  and  $Y$ . Use same methods to predict  $H_2$  flux  $Pd_{74}Cu_{22}M_4$  for at least 3 of the same  $M$ .
- *Milestone 1.2:* Screening of initial set ( $\leq 6$ ) of ternary alloys by pure gas ( $H_2$  and  $N_2$ ) permeation experiments.

## Phase II (Year 2)

- *Milestone 2.1:* Fabricate a minimum of 20 membrane specimens with different copper concentrations based on CMU hydrogen transport predictions for the 2-3 most promising ternary element additions.
- *Milestone 2.6:* Complete 4-5 preliminary tests membrane samples at TDA and IdaTech with clean Syngas and single impurity additions of  $H_2S$  and  $COS$ .

## Phase III (Year 3)

- *Milestone 3.1:* Produce a minimum of 5 sq. ft. of optimized membrane material for use at CSM and TDA and for independent third-party evaluation by IdaTech.
- *Milestone 3.2:* CSM will complete mixture permeation testing with  $H_2/CO$  and  $H_2/H_2S$  binary mixtures with best three samples from the final optimization study.



# Ternary Alloys for Metal Membranes

- Binary alloys have well known advantages relative to pure Pd
  - avoid membrane embrittlement by making hydride phase less stable
  - some binary alloys have higher permeability than pure Pd
  - some binary alloys have better impurity resistance than pure Pd
- Ternary alloys have potential for improving upon binary alloys, but choosing appropriate alloys to test is a significant challenge

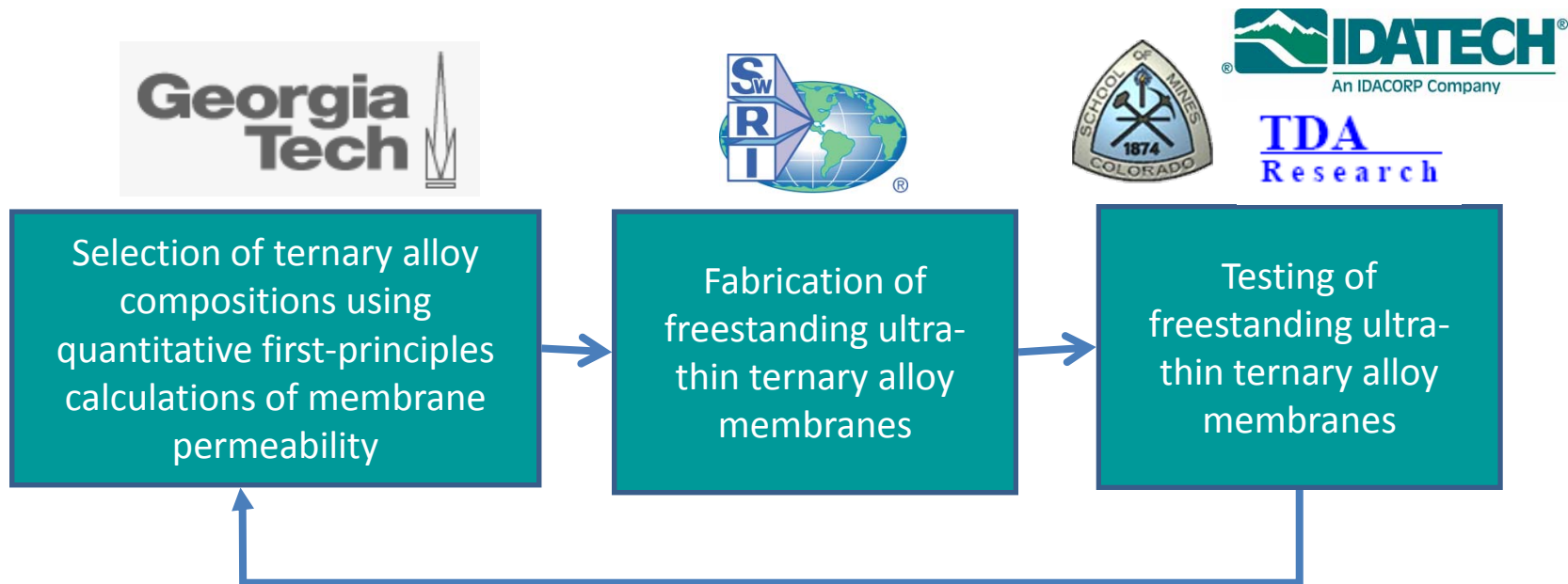



# DFT-Based Modeling of H in Ternary Metal Alloys

One simple way to define a site's surroundings is to count the number of atoms of each metal in the two nearest shells of atoms forming the site

99.67% of O sites are made of nine types in binary  $\text{Pd}_{96}\text{M}_4$  alloys.

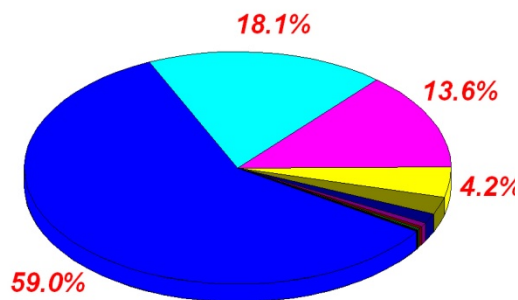

89.94% of O sites are made of **72** types in ternary  $\text{Pd}_{70}\text{Cu}_{26}\text{M}_4$  alloys.

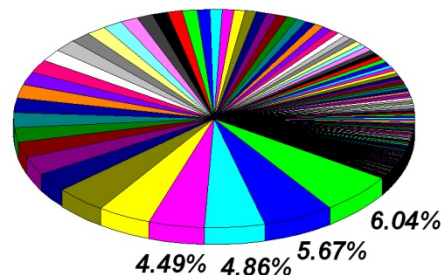

We have developed efficient and accurate methods to tackle two key challenges:

1. A very large number of sites must be sampled with DFT calculations
2. A statistically valid model that extends DFT data to include all possible sites is needed



# Model Development for Binary and Ternary Alloys

DFT data is generated for hundreds of distinct binding sites and transition states

Model derived from DFT data via cluster expansion methods

These methods examine many possible models and apply statistical methods to choose best model  
(Semidey-Flecha and Sholl, J. Chem. Phys., 128 (2008) 144701)

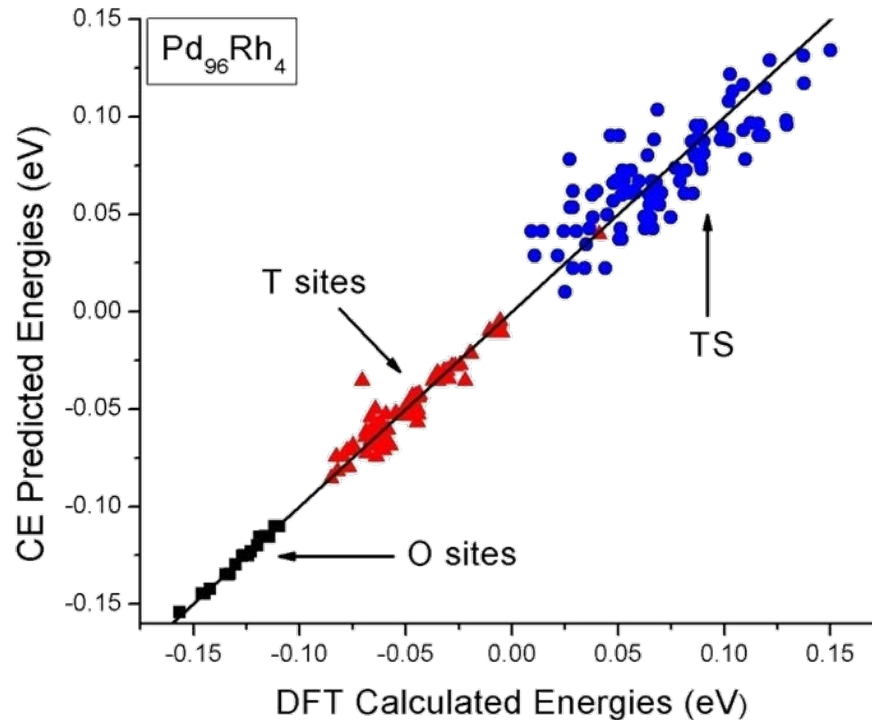

From these models, H<sub>2</sub> permeance is predicted by separately calculating H solubility and diffusion (Kamakoti et al., Science 307 (2005) 569)





# Predicted Permeabilities of Binary Alloys

DFT-based models developed for 7 alloys with composition Pd<sub>96</sub>M<sub>4</sub> (at.%)

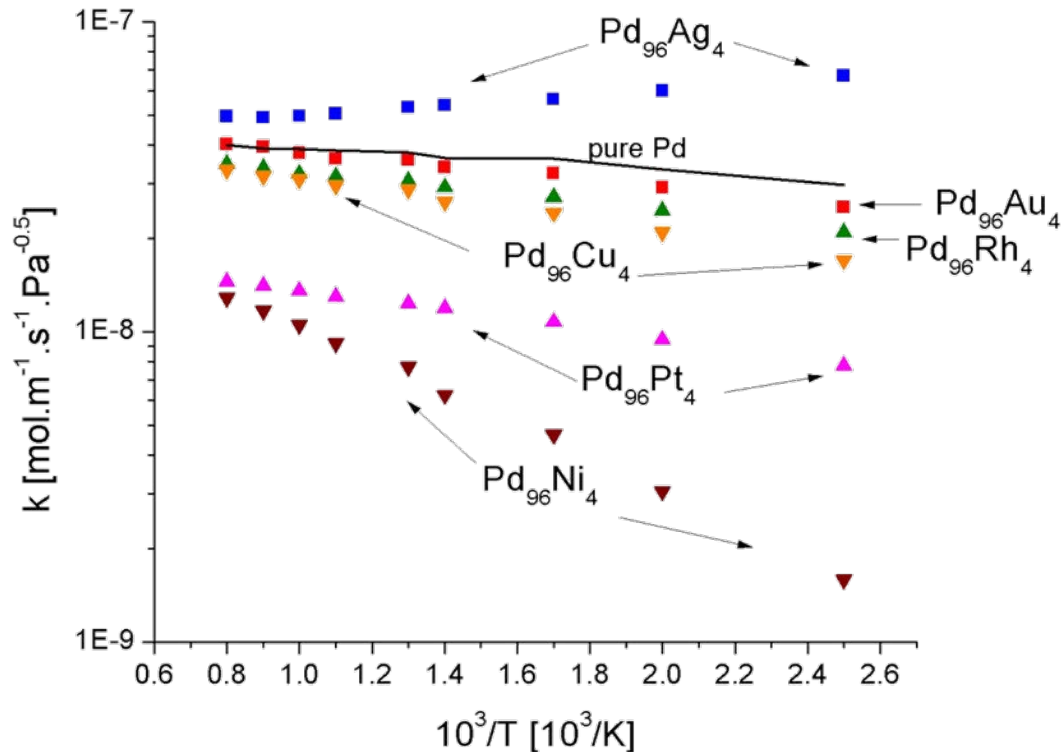

Model predictions are in good agreement with literature data for binary alloys:

- Adding Ag or Au either increases or holds permeability constant relative to Pd
- Adding Ni or Pt significantly diminishes permeability relative to pure Pd



# Predicted Permeabilities of Ternary Alloys

Multiple alloys examined with composition Pd<sub>70</sub>Cu<sub>26</sub>M<sub>4</sub> (at.%)

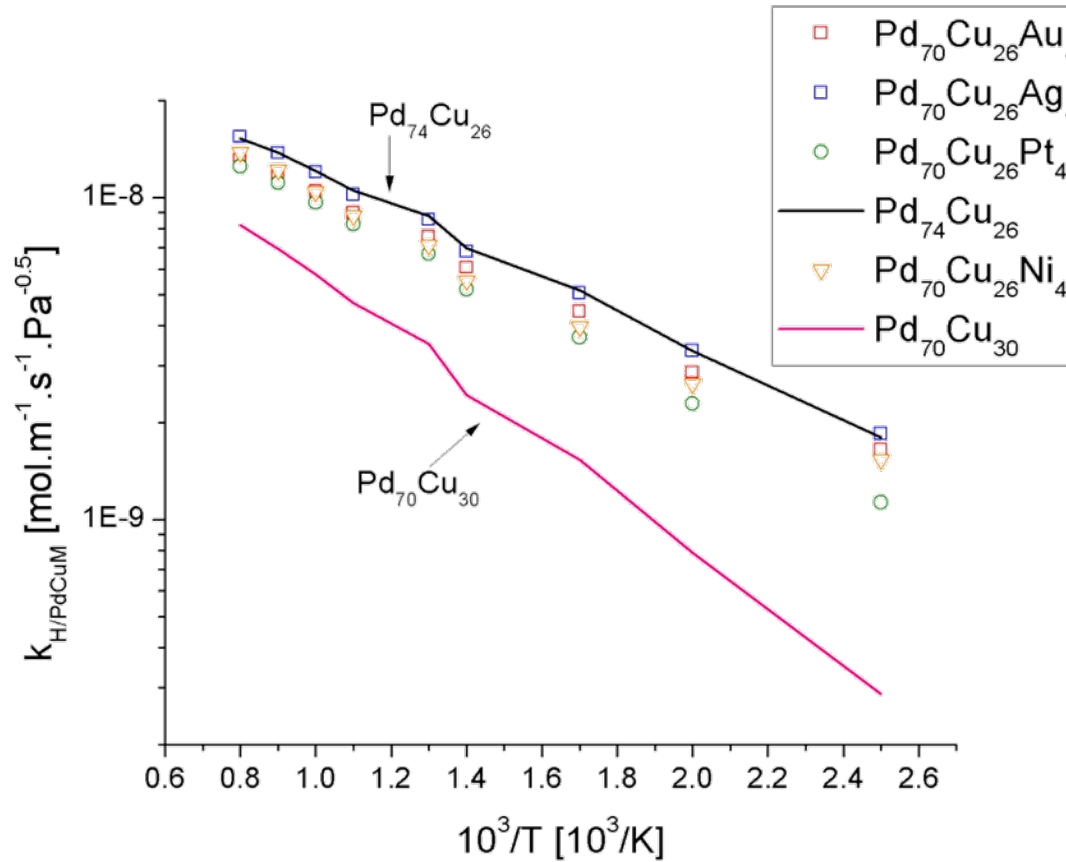



# Membrane Fabrication

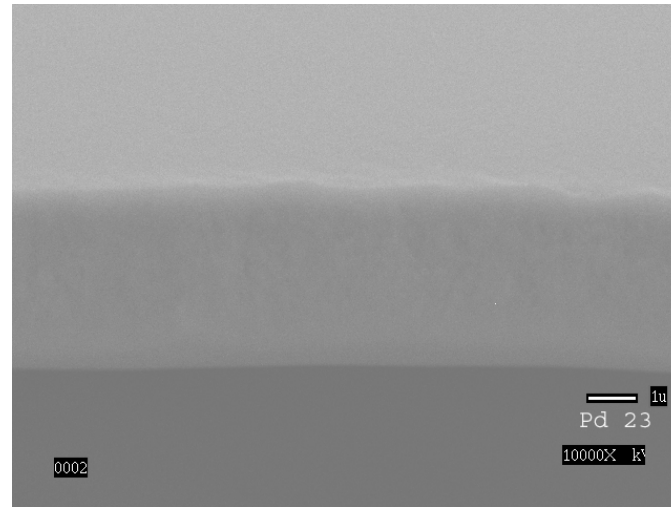
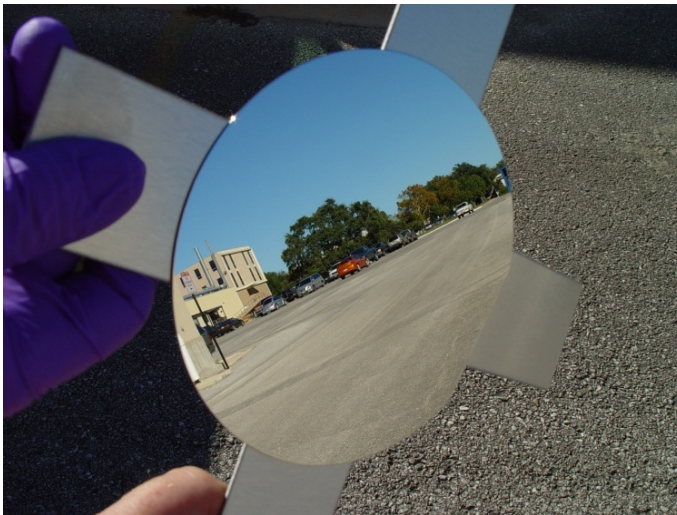
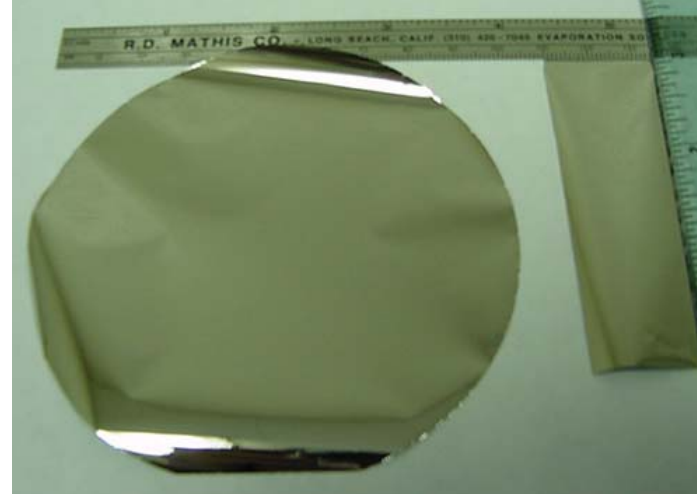

Base press	substrates	spin speed	run time	Thickness	Ar press	Sput pwr (kw)	Sput Volt	Sput Amp
1.3-7T	6" wafer	60 + sweep	4hrs 24min	10 um	9.4-4T	780 watts	498	1.65



# Composition Control

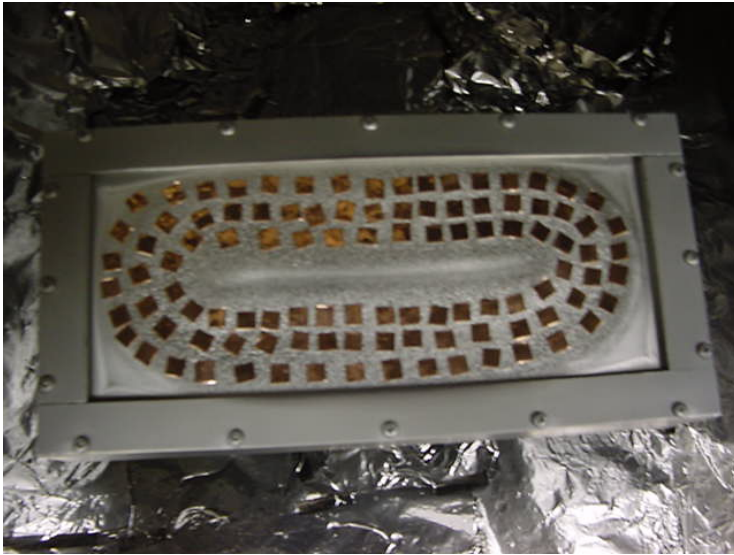

$\text{Pd}_{60}\text{Cu}_{40}$



$\text{Pd}_{80}\text{Cu}_{17}\text{Ag}_4$

- Composition can be controlled using areal coverage calculation
- Uniform through 10 $\mu\text{m}$  thick foil
- No Pd target contamination
  - Can change composition & materials



# Foils Released in Last 12 Months

PD-69	Pd/Cu/Pt 70/17/13%	74.9	12.4	-	12.7	-	-	-	76.7	11.0	-	12.3	-	-	-
PD-72	Pd/Cu/Au 70/17/13%	71.2	17.7	-	-	11.1	-	-	71.4	12.3	-	-	16.2	-	-
PD-73	Pd/Cu/Au 70/17/13%	70.9	13.4	-	-	15.7	-	-	71.1	12.0	-	-	16.9	-	-
PD-74	Pd/Cu/Au 70/17/13%	70.6	12.9	-	-	16.6	-	-	74.5	11.8	-	-	13.7	-	-
PD-75	Pd/Cu/Au 70/17/13%	79.8	11.9	-	-	8.3	-	-	74.2	12.2	-	-	13.6	-	-
PD-78	Pd/Cu/Ni 75/17/8%	79.6	12.6	-	-	-	-	7.9	74.3	18.1	-	-	-	-	7.6
PD-79	Pd/Cu/Ni 75/17/8%	78.5	14.0	-	-	-	-	7.5	78.8	14.1	-	-	-	-	7.1
PD-80	Pd/Cu/Ni 75/17/8%	77.2	15.2	-	-	-	-	7.6	76.4	16.5	-	-	-	-	7.1
PD-81	Pd/Cu/Ni 75/17/8%	78.7	13.7	-	-	-	-	7.6	76.6	15.6	-	-	-	-	7.7
PD-84	Pd-Ru 90/10%	94.7	-	-	-	-	5.3	-	93.4	-	-	-	-	6.6	-
PD-85	Pd-Ru 90/10%	93.5	-	-	-	-	6.5	-	92.9	-	-	-	-	7.1	-
PD-86	Pd-Ru 90/10%	92.8	-	-	-	-	7.3	-	92.9	-	-	-	-	7.1	-
PD-87	Pd-Ru 90/10%	92.9	-	-	-	-	7.1	-	92.9	-	-	-	-	7.2	-
PD-89	Pd/Cu/Ru 85/5/10%	88.3	4.3	-	-	-	7.5	-	88.0	4.5	-	-	-	7.6	-
PD-90	Pd/Cu/Ru 85/5/10%	87.6	5.2	-	-	-	7.3	-	88.0	4.7	-	-	-	7.3	-
PD-93	Pd/Cu/Au 85/5/10%	82.3	6.1	-	-	11.7	-	-	82.4	5.2	-	-	12.5	-	-
PD-94	Pd/Cu/Au 85/5/10%	81.6	5.6	-	-	12.9	-	-	81.6	5.1	-	-	13.3	-	-
PD-95	Pd/Cu/Au 85/5/10%	81.8	5.2	-	-	13.0	-	-	83.5	4.6	-	-	11.9	-	-
PD-96	Pd/Cu/Au 85/5/10%	83.4	5.3	-	-	11.3	-	-	84.6	4.2	-	-	11.1	-	-
PD-99	Pd/Cu/Au 65/35/5%	63.5	28.0	-	-	8.5	-	-	60.3	34.1	-	-	5.6	-	-
PD-69	Pd/Cu/Pt 70/17/13%	74.9	12.4	-	12.7	-	-	-	76.7	11.0	-	12.3	-	-	-
PD-72	Pd/Cu/Au 70/17/13%	71.2	17.7	-	-	11.1	-	-	71.4	12.3	-	-	16.2	-	-
PD-73	Pd/Cu/Au 70/17/13%	70.9	13.4	-	-	15.7	-	-	71.1	12.0	-	-	16.9	-	-
PD-74	Pd/Cu/Au 70/17/13%	70.6	12.9	-	-	16.6	-	-	74.5	11.8	-	-	13.7	-	-
PD-75	Pd/Cu/Au 70/17/13%	79.8	11.9	-	-	8.3	-	-	74.2	12.2	-	-	13.6	-	-
PD-78	Pd/Cu/Ni 75/17/8%	79.6	12.6	-	-	-	-	7.9	74.3	18.1	-	-	-	-	7.6
PD-79	Pd/Cu/Ni 75/17/8%	78.5	14.0	-	-	-	-	7.5	78.8	14.1	-	-	-	-	7.1
PD-80	Pd/Cu/Ni 75/17/8%	77.2	15.2	-	-	-	-	7.6	76.4	16.5	-	-	-	-	7.1
PD-81	Pd/Cu/Ni 75/17/8%	78.7	13.7	-	-	-	-	7.6	76.6	15.6	-	-	-	-	7.7
PD-84	Pd-Ru 90/10%	94.7	-	-	-	-	5.3	-	93.4	-	-	-	-	6.6	-
PD-85	Pd-Ru 90/10%	93.5	-	-	-	-	6.5	-	92.9	-	-	-	-	7.1	-
PD-86	Pd-Ru 90/10%	92.8	-	-	-	-	7.3	-	92.9	-	-	-	-	7.1	-
PD-87	Pd-Ru 90/10%	92.9	-	-	-	-	7.1	-	92.9	-	-	-	-	7.2	-
PD-89	Pd/Cu/Ru 85/5/10%	88.3	4.3	-	-	-	7.5	-	88.0	4.5	-	-	-	7.6	-
PD-90	Pd/Cu/Ru 85/5/10%	87.6	5.2	-	-	-	7.3	-	88.0	4.7	-	-	-	7.3	-
PD-93	Pd/Cu/Au 85/5/10%	82.3	6.1	-	-	11.7	-	-	82.4	5.2	-	-	12.5	-	-
PD-94	Pd/Cu/Au 85/5/10%	81.6	5.6	-	-	12.9	-	-	81.6	5.1	-	-	13.3	-	-
PD-95	Pd/Cu/Au 85/5/10%	81.8	5.2	-	-	13.0	-	-	83.5	4.6	-	-	11.9	-	-
PD-96	Pd/Cu/Au 85/5/10%	83.4	5.3	-	-	11.3	-	-	84.6	4.2	-	-	11.1	-	-
PD-99	Pd/Cu/Au 65/35/5%	63.5	28.0	-	-	8.5	-	-	60.3	34.1	-	-	5.6	-	-

13 binary & >25 ternary



# The Influence of Reciprocal Thickness on the Pure Hydrogen Flux at 400°C and 32 psia Hydrogen Feed Pressure

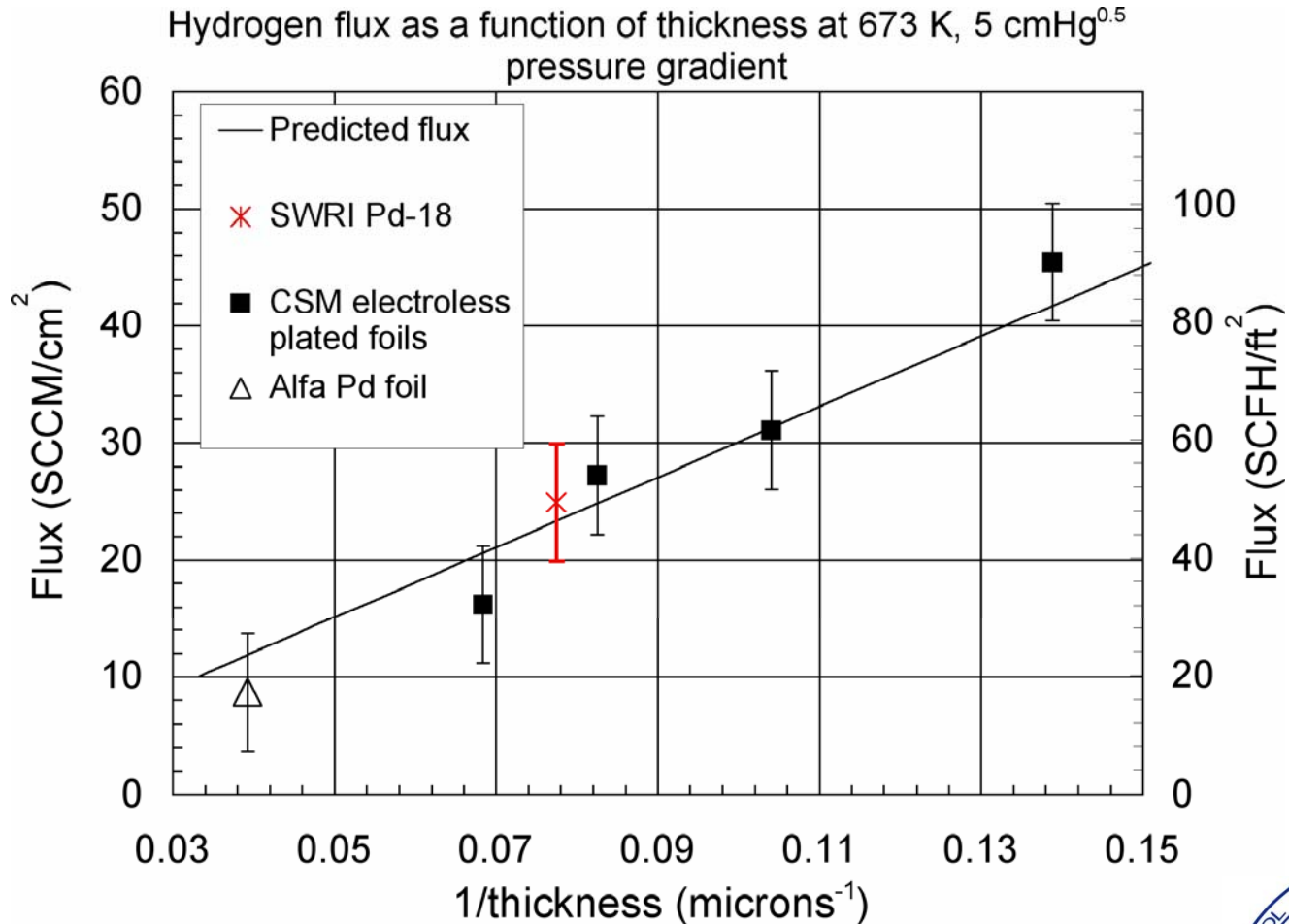



# Effect of Composition on Hydrogen Permeability for PdCuAu Ternary membranes

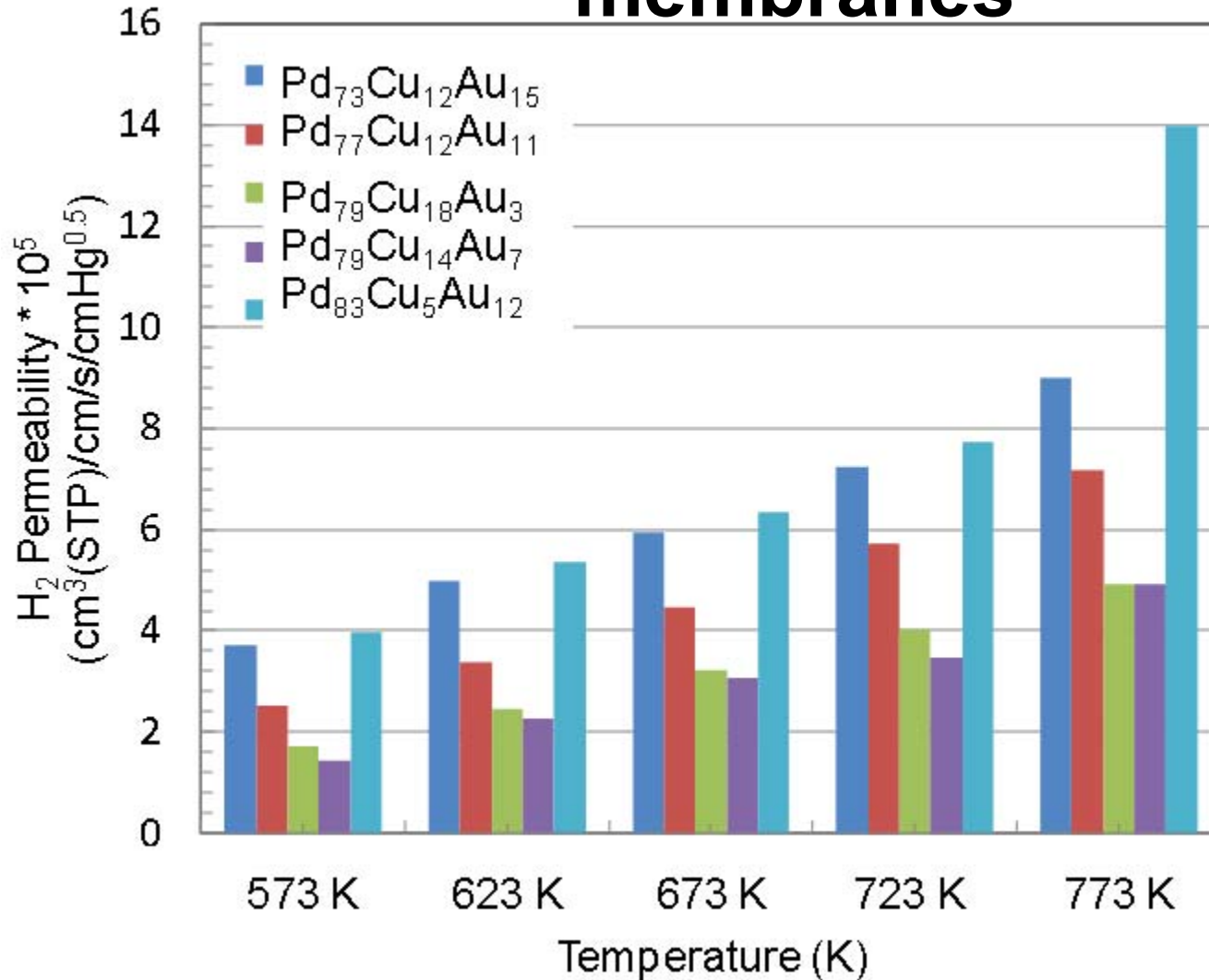



# H<sub>2</sub> Flux as a Function of Pressure Gradient for a Pd<sub>73</sub>Cu<sub>12</sub>Au<sub>15</sub>, 12.8 μm Foil

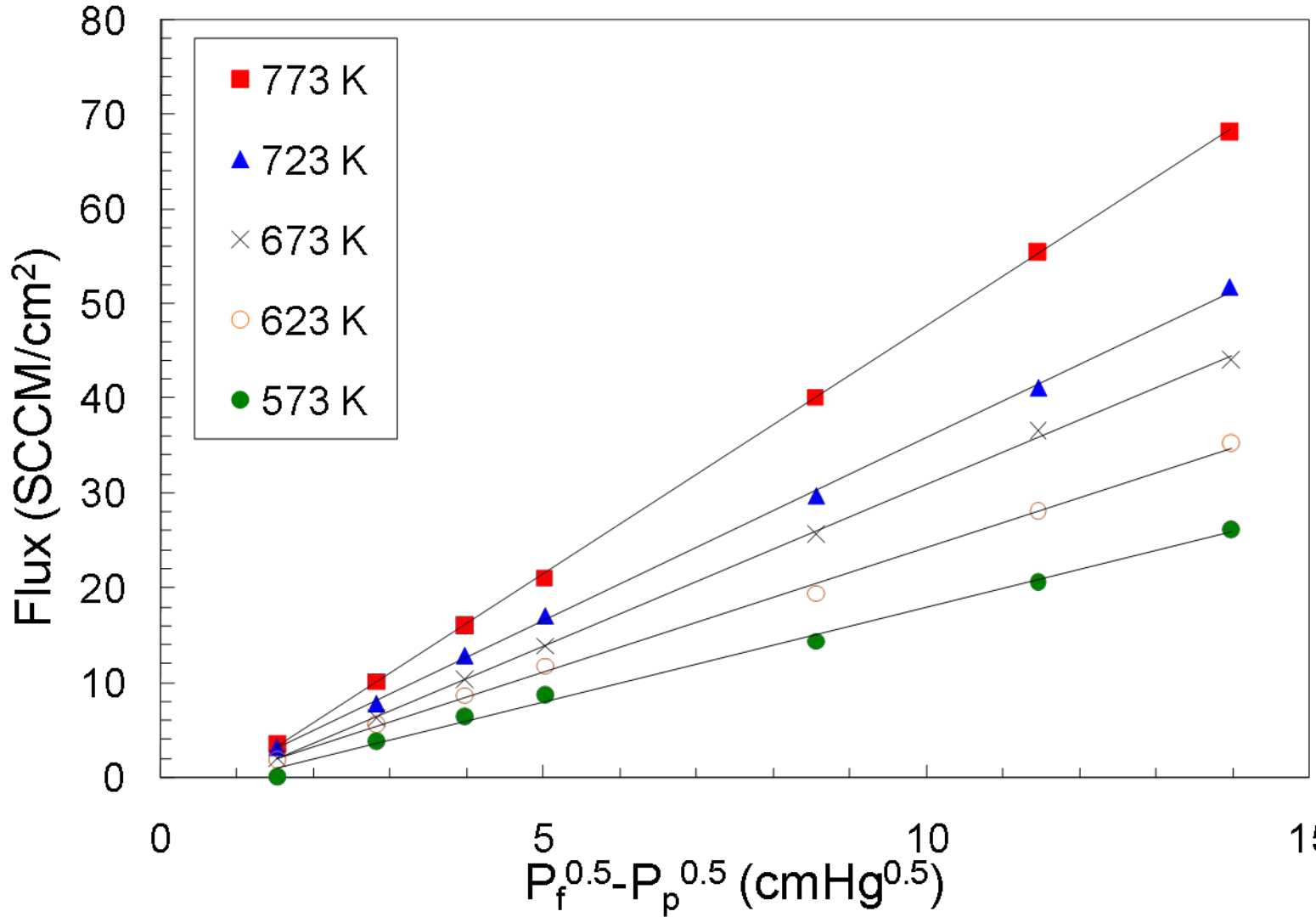





# Hydrogen Permeability for Ternary Alloy Membranes

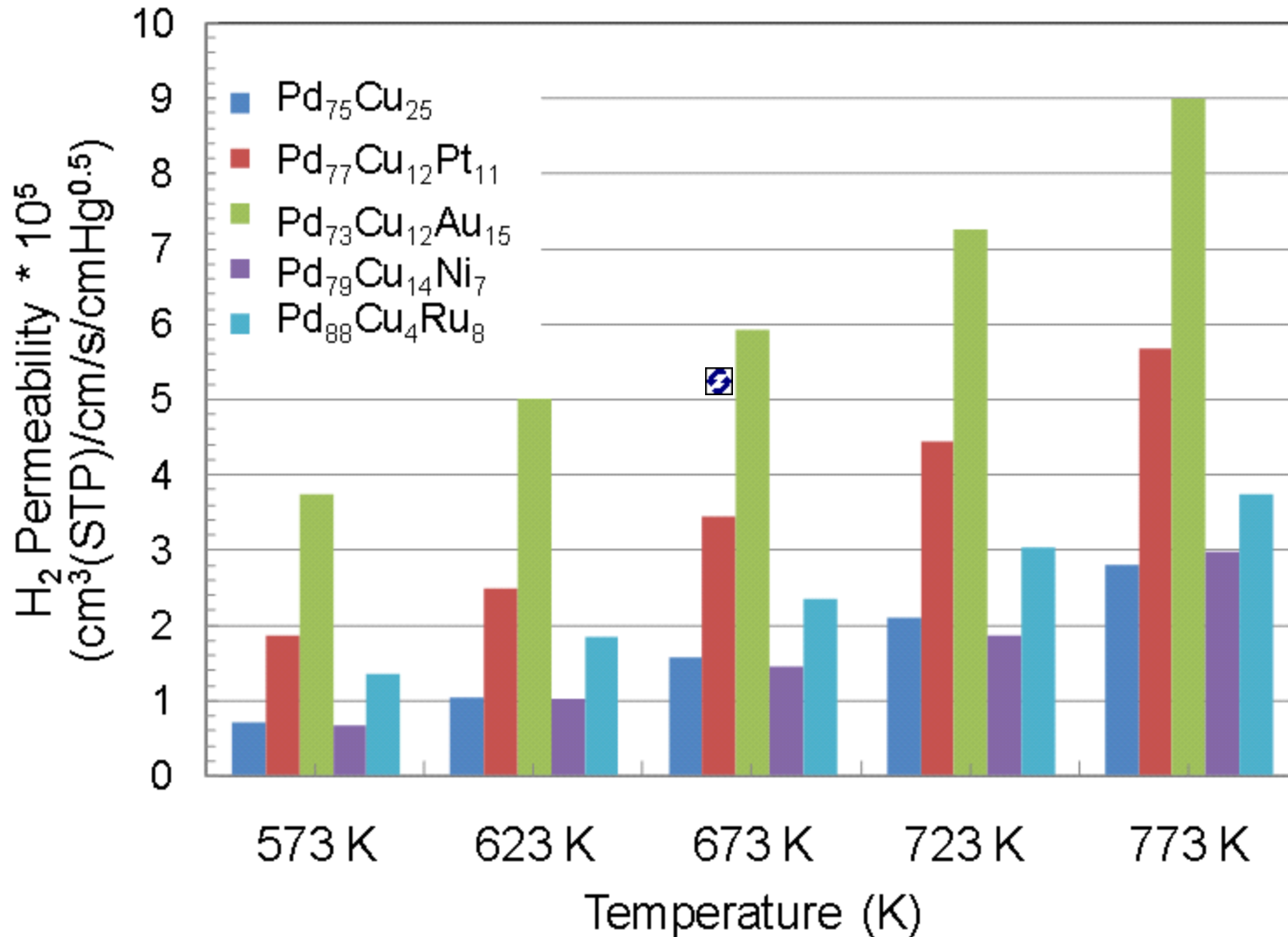



# Single-Gas H<sub>2</sub> Permeabilities for Binary and Ternary Alloy Membranes

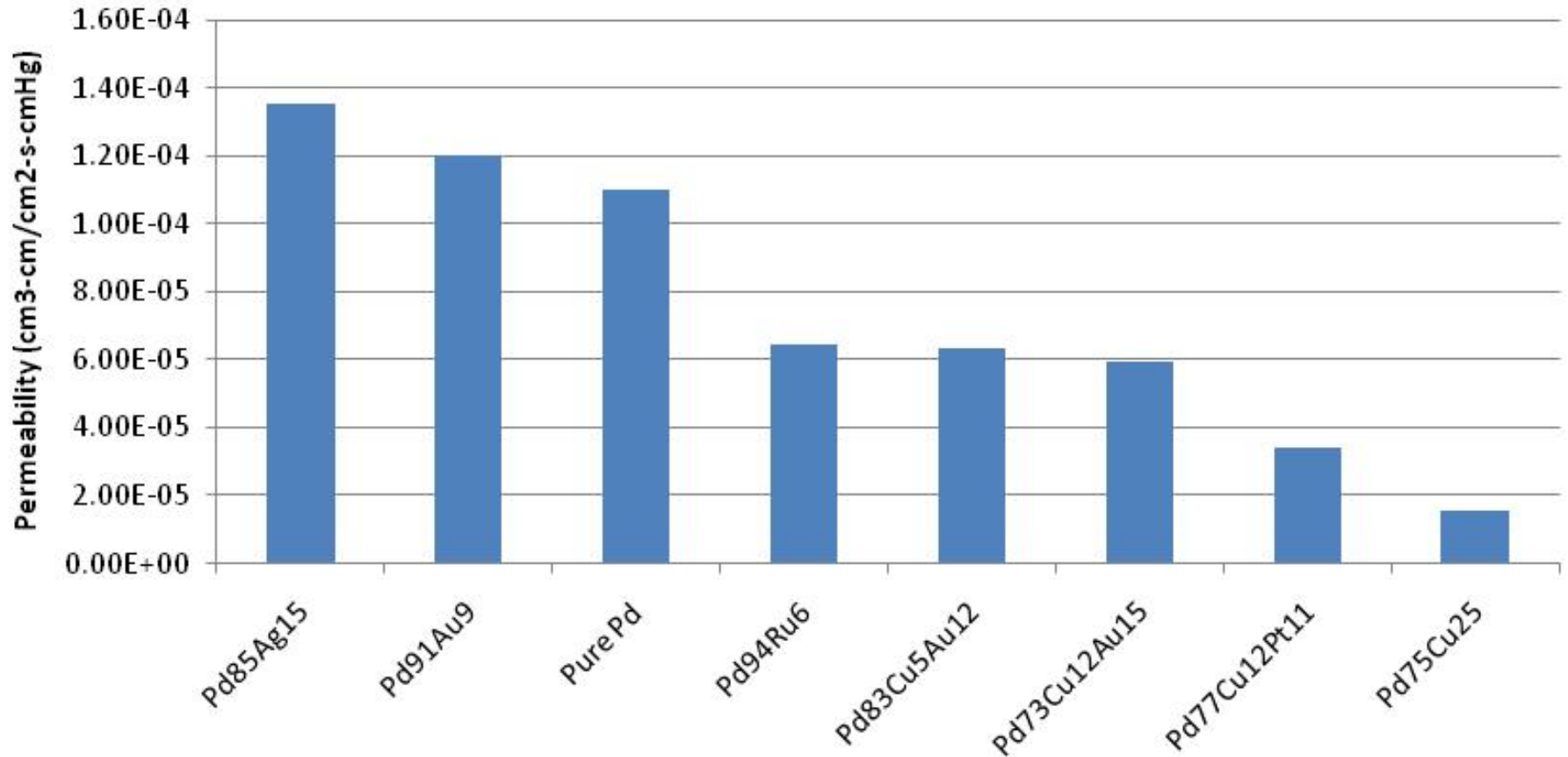



# Theoretical and Experimental Results Normalized with Respect to Pure Pd

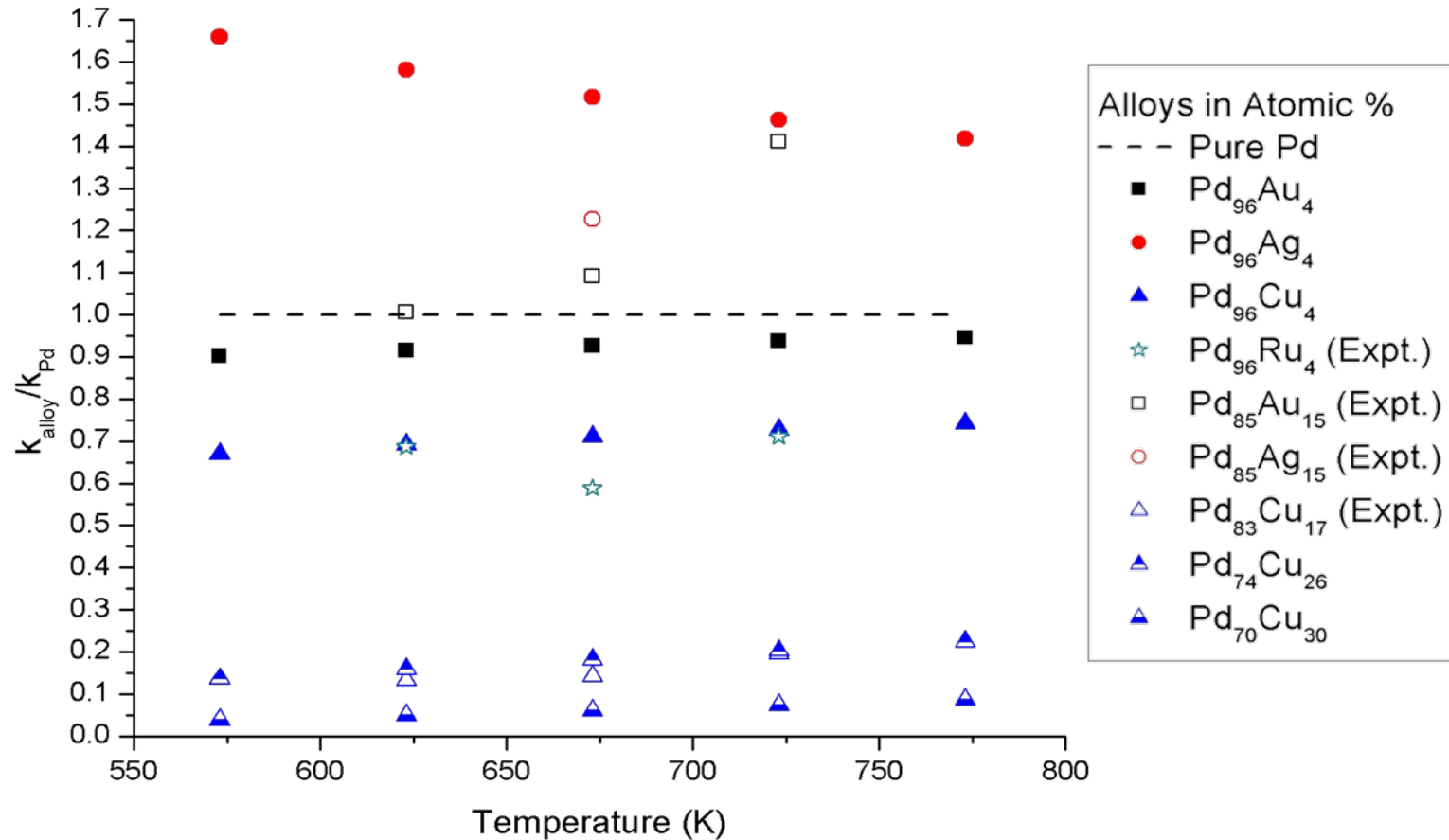



# Theoretical and Experimental Results Normalized with Respect to Pure Pd

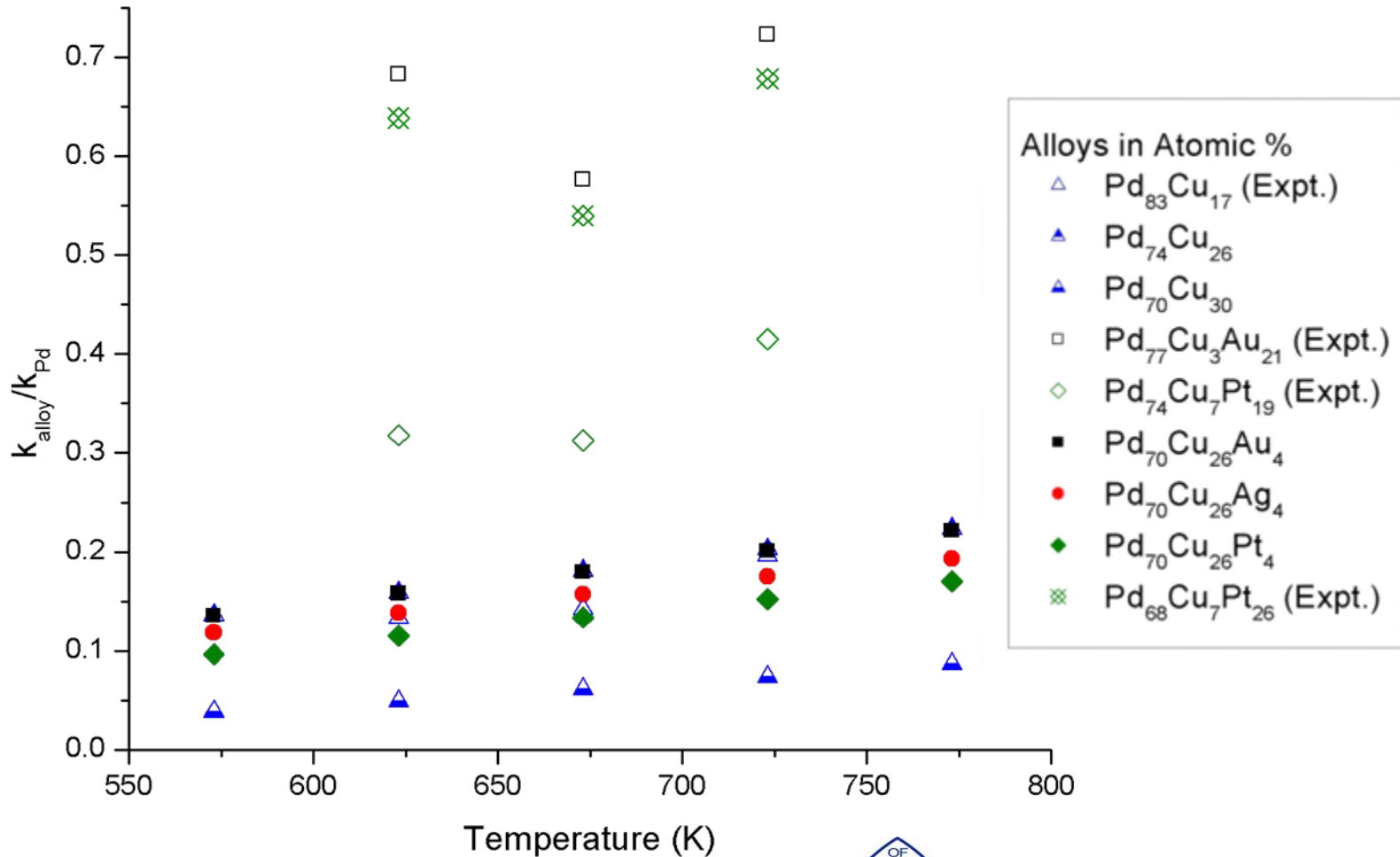



# Testing Protocol

	Test Phase			
	Test 1	Test 2 a	Test 2 b	Test 2 c
<b>Feed Gas Composition (Before correction for addition of He)</b>				
H <sub>2</sub> (%)	50.0	50.0	33.0	4.8
CO (%)	1.0	1.0	1.3	2.0
CO <sub>2</sub> (%)	30.0	30.0	40.0	57.0
H <sub>2</sub> O (%)	19.0	19.0	25.0	36.2
H <sub>2</sub> S (%)	0.000	0.002	0.003	0.004
<b>Sweep Gas Composition</b>				
Ar (%)	100	100	100	100
<b>Total Feed Pressure (psia)</b>	200	200	200	200
<b>H<sub>2</sub> Feed Pressure (psia)</b>	100	100	66	9.6
<b>Total Sweep Pressure (psia)</b>	<30	<30	<30	<30
<b>(P<sub>H<sub>2</sub>S</sub>/P<sub>H<sub>2</sub></sub>)<sub>Feed</sub></b>	0.00E+00	4.00E-05	9.09E-05	8.33E-04
<b>Temperature (°C)</b>	300-600	300-600	300-600	300-600



# TDA Test Apparatus

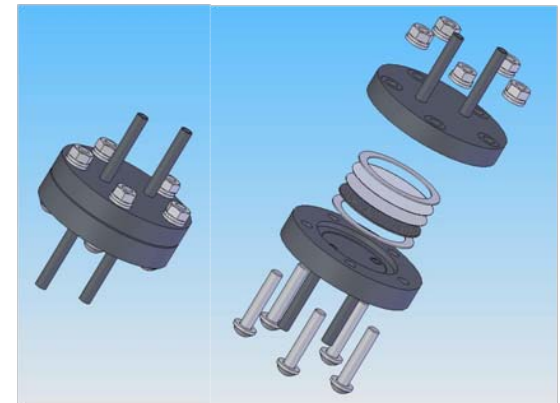
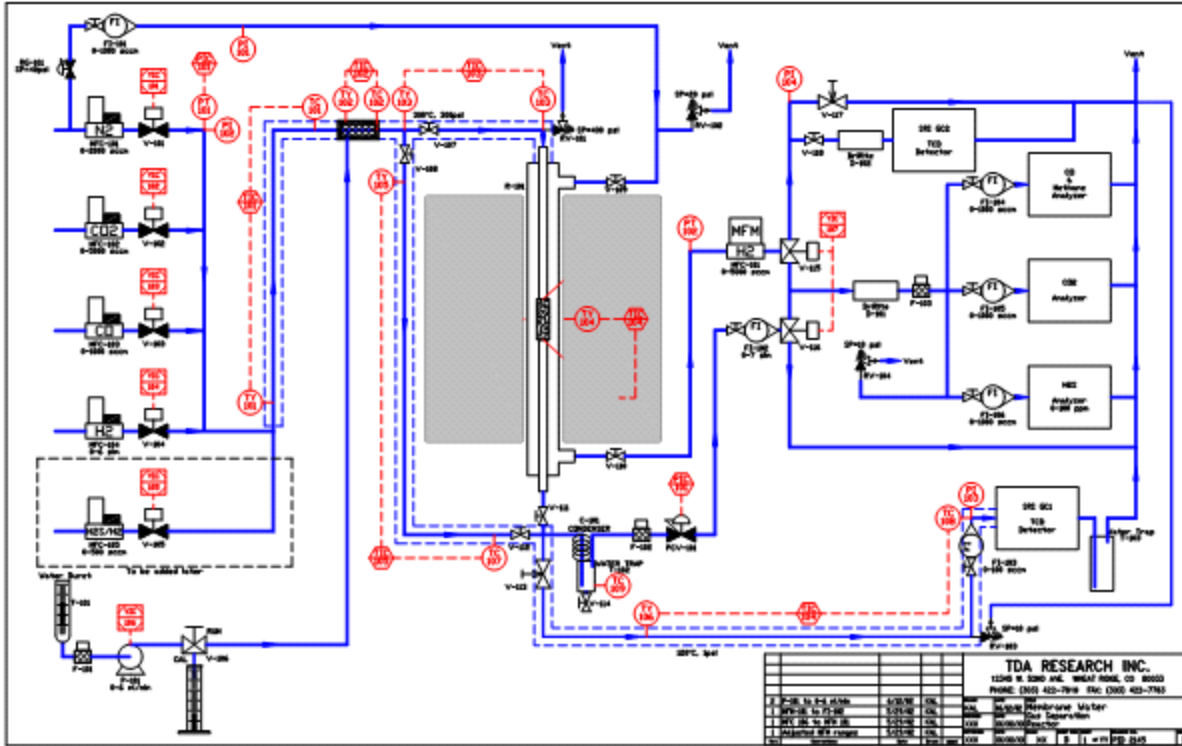

- On-line non-dispersive infrared detectors to continuously measure CO, CO<sub>2</sub>
- Two SRI Model 8610A gas chromatograms (GC) and appropriate gas analyzers,
- Control E/G software is used to control the apparatus and provides unattended operation.



# Evaluation of Pd-51

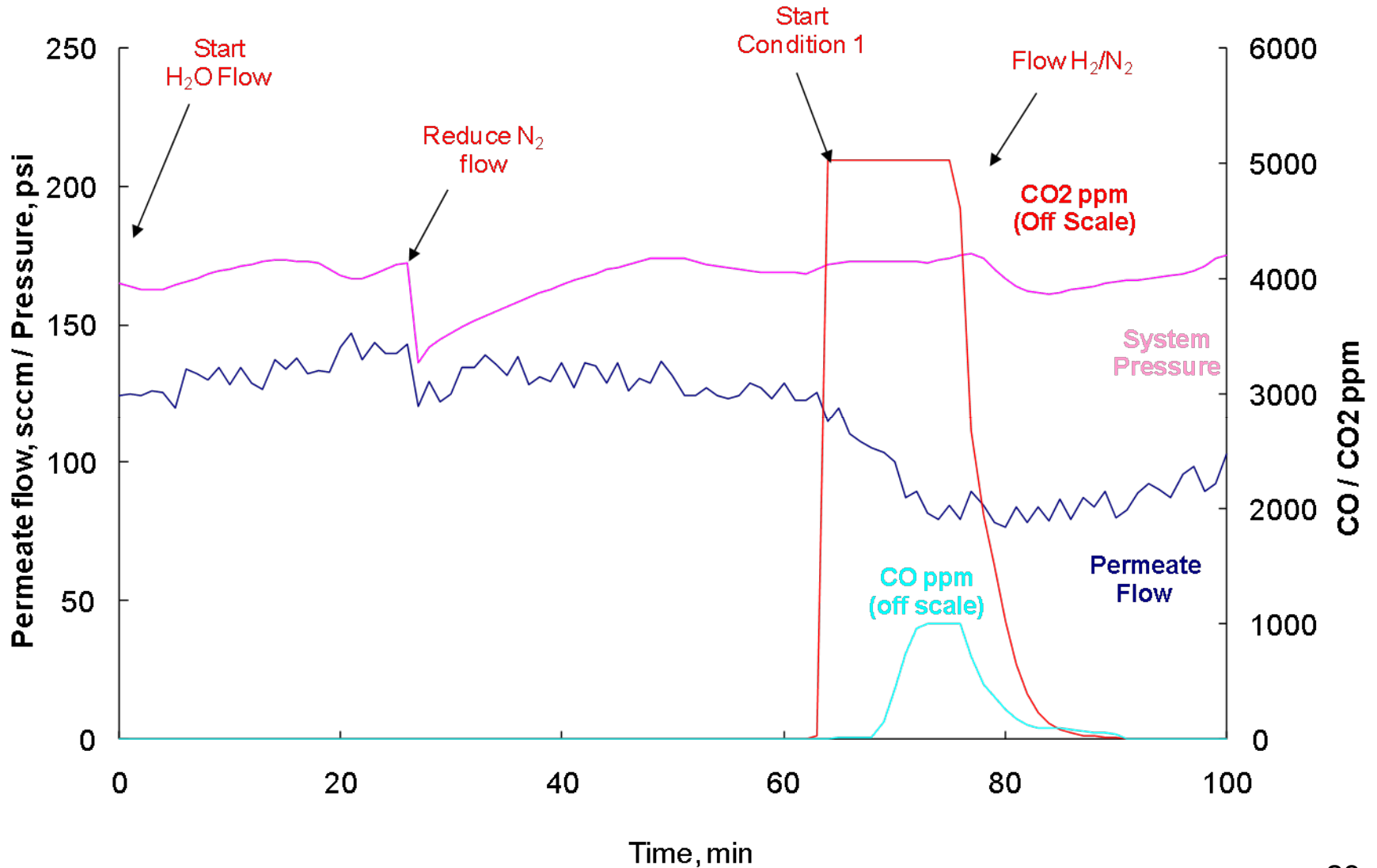



# Evaluation of Pd-48

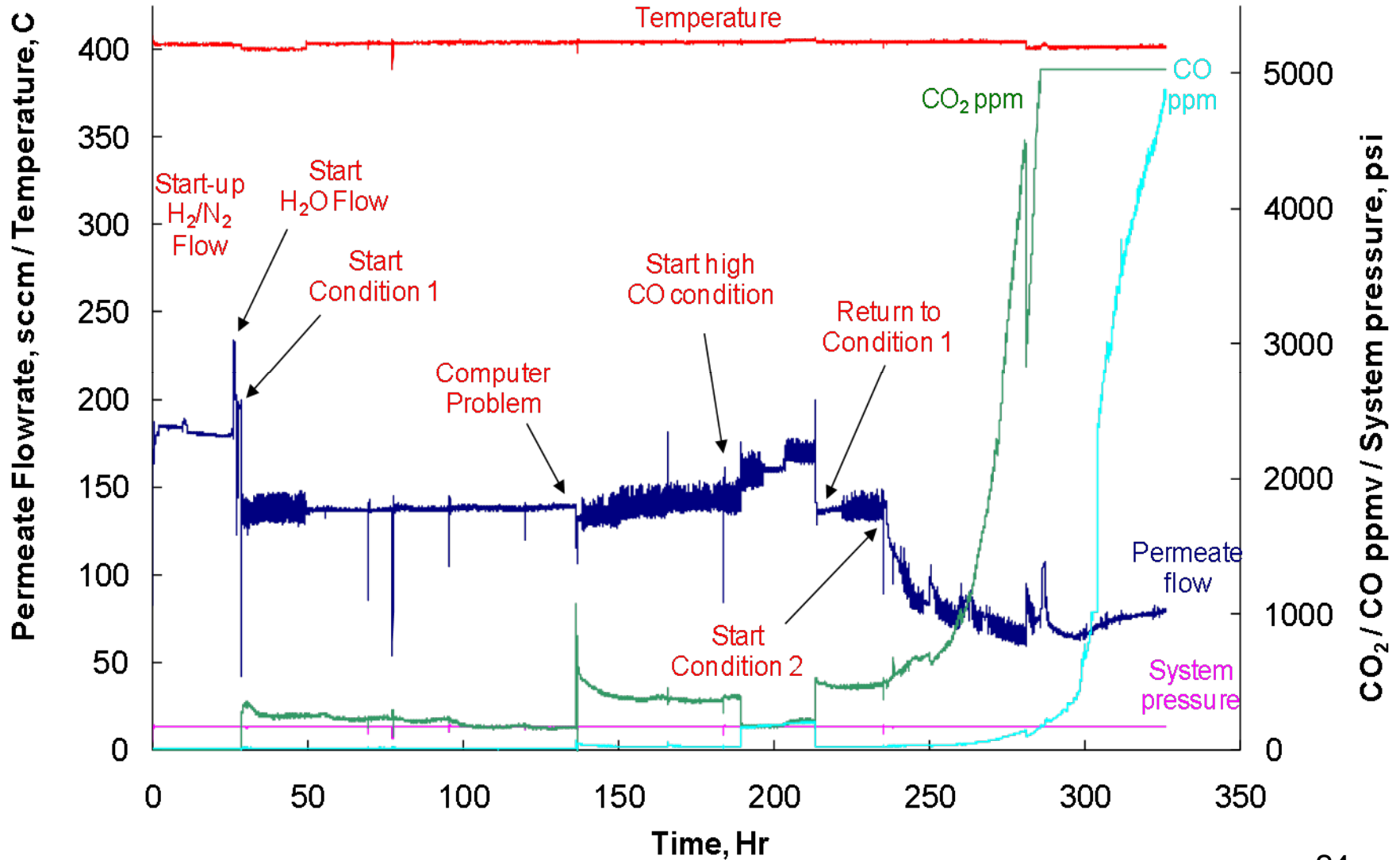





# Evaluation of Pd-48

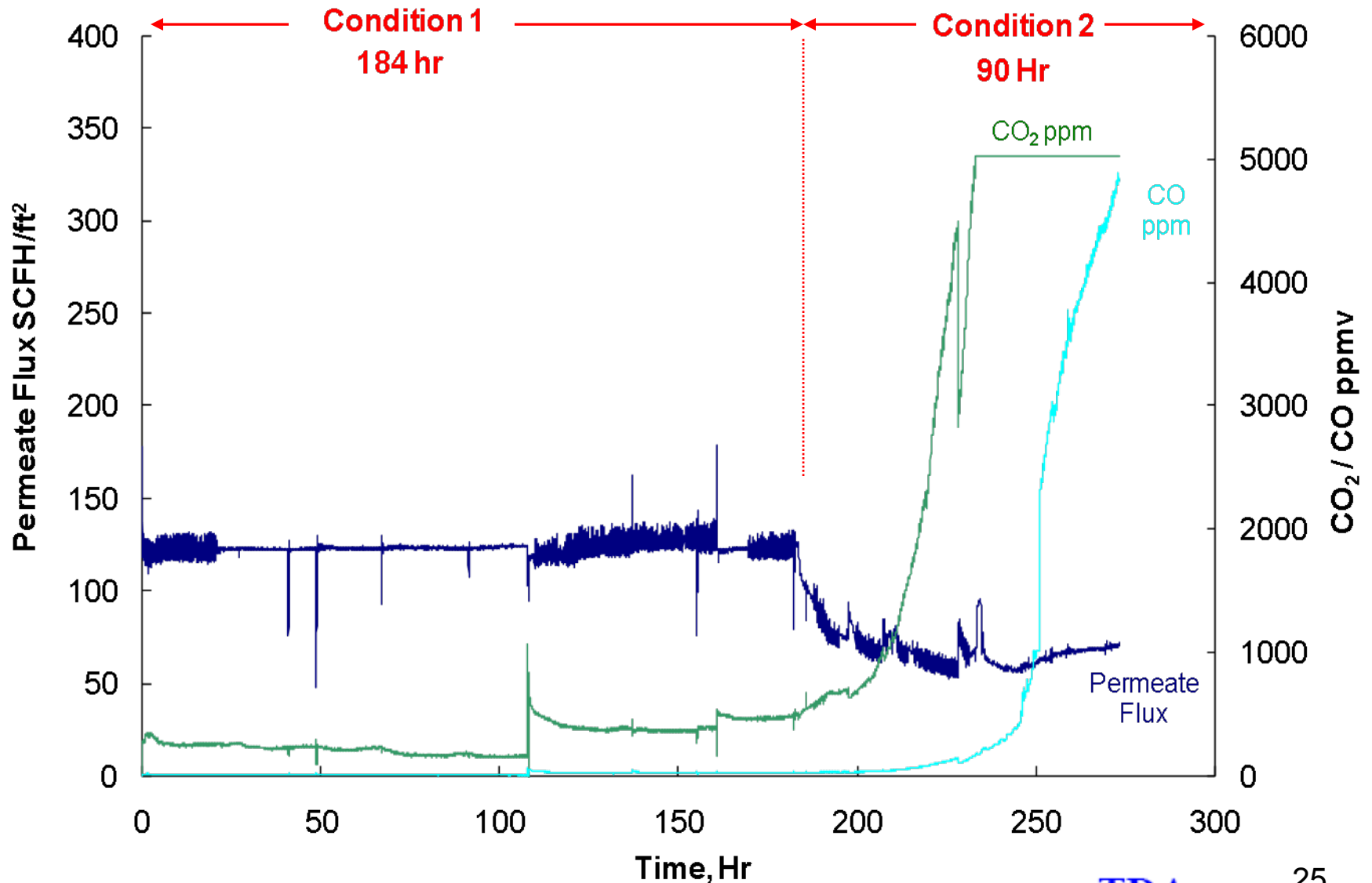



# N<sub>2</sub> Permeation Before/After Testing

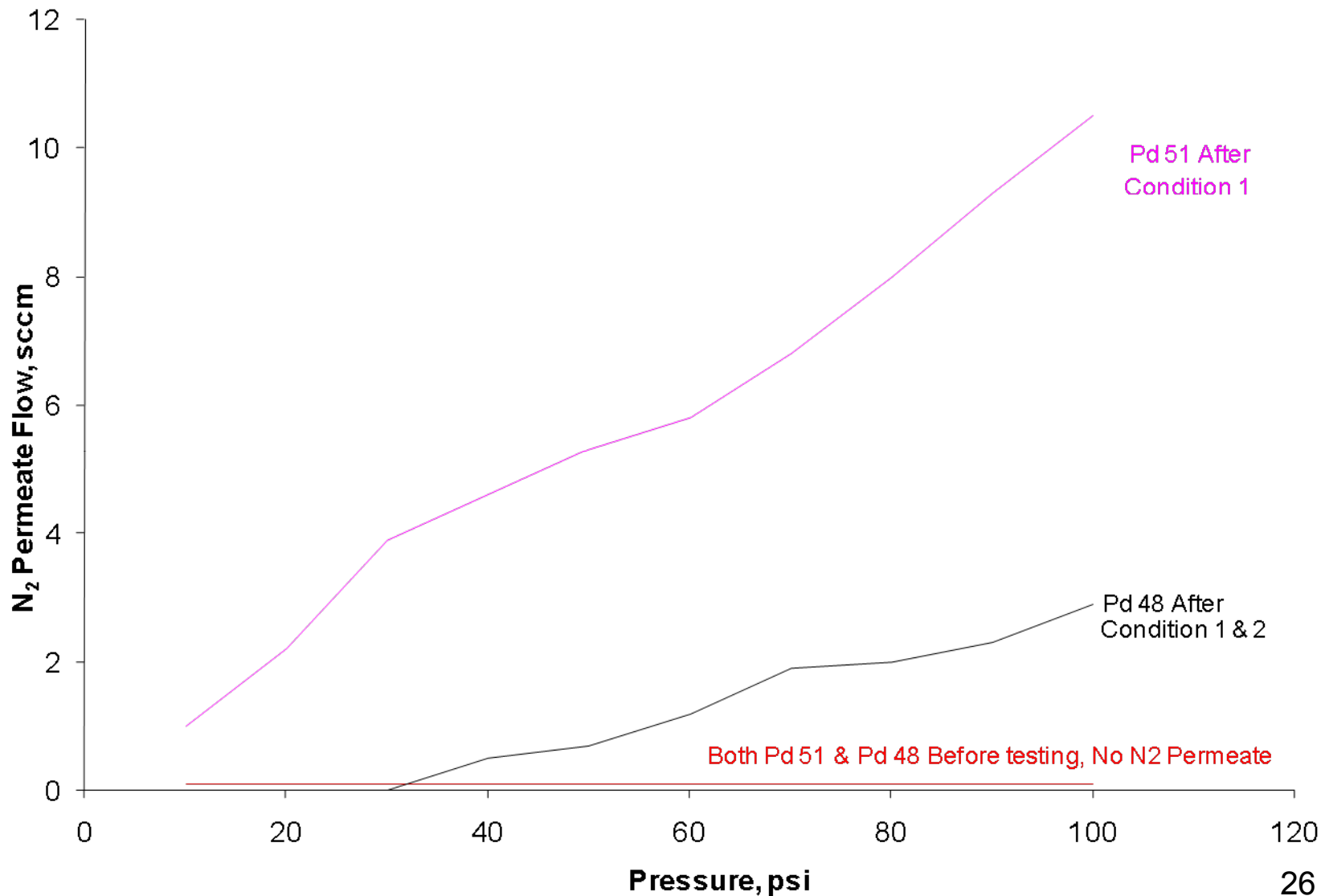



# IdaTech

- Issues with membrane mechanical strength – have successfully used the membrane test assembly with 5um thick foils, so investigating mechanical (test fixture tolerances) and startup procedures.
- Achieved 33% higher hydrogen permeability at 400°C than that reported by CSM– suspect difference in membrane conditioning.
- Pd72b started out leak free but the before and after air leak tests at 100 psig were 4 cc/min.
- When the membrane assembly cooled and was transferred to sulfur poisoned furnace, the membrane failed when it had reached temperature and 100 psig syn gas was applied.
- Additional data





# Summary (Year 1)

- A rigorous strategy for predicting H permeability through ternary alloys using first-principles calculations has been developed for
  - Pd-Cu-Ag and Pd-Cu-Au
  - Calculations in progress: Pd-Cu-Ni and Pd-Cu-Pt
- Thin (5-10 micron) membranes of Pd<sub>60</sub>Cu<sub>40</sub>, Pd<sub>96</sub>M<sub>4</sub> and Pd<sub>74</sub>Cu<sub>22</sub>Ag<sub>4</sub> have been coated and these samples provided to CSM for structural and composition measurements and permeation testing
- Pure gas hydrogen and nitrogen permeation rates have been determined at CSM for a range of pressure differentials (5 to 150 psig feed pressure) and temperatures ranging from 200 to 500°C.
- Freestanding alloy films of Pd, Pd-Cu, and Pd-Cu-Ag show
  - Pure Pd and Pd-Cu alloys give permeabilities in reasonable agreement with prior literature
  - Preliminary tests indicate that adding ~4 wt.% Ag improves permeability of Pd-Cu by ~20-25%.
- Program is on-schedule and on budget.



# Summary (Year 2)

- Choice of reference material strongly affects how results are viewed.
- All ternary additives strongly enhance permeation relative to  $\text{Pd}_{70}\text{Cu}_{30}$ , but all except Ag cause slightly decrease in permeation relative to  $\text{Pd}_{74}\text{Cu}_{26}$
- Over 37 binary and ternary films have been fabricated with specific compositions to test hydrogen permeability & sulfur tolerance.
- Hydrogen transport appears to be bulk-diffusion limited for all membranes tested at temperatures above 573 K.
- PdCuAu has the highest permeability of the ternary alloys tested.
- Binary alloys of palladium with copper, silver, gold, and ruthenium have comparable permeabilities to literature values.
- In ternary PdCuAu alloys studied, reducing copper content and raising gold content improves permeability.
- Over 5 membranes have been tested under DOE specified test conditions.
- Program is on schedule and on budget.



# Future Work

**The following milestones will be addressed in Year 3.**

- Produce a minimum of 5 sq. ft. of optimized membrane material for use at CSM and TDA and for independent third-party evaluation by IdaTech.
- Complete mixture permeation testing with using DOE specified mixtures with best three samples from the final optimization study

## **Specifics**

- Continue model validation with pure hydrogen and test mixtures for ternary PdCuX combinations at different stoichiometry.
- Using the data obtained in Years 1&2 an optimization of the membrane form factor (composition, thickness, foot-print, etc.) will occur.



# Additional Slides



# Single-gas H<sub>2</sub> Permeabilities for Binary and Ternary Alloy Membranes

Membrane ID	Composition (wt%)	Hydrogen Permeability at 20 psi feed, ambient permeate (cm <sup>3</sup> (STP)-cm/cm <sup>2</sup> -s-cmHg <sup>n</sup> )				
		573 K	623 K	673 K	723 K	773 K
Pd-63	Pd <sub>75</sub> Cu <sub>25</sub>	7.05E-06	1.04E-05	1.56E-05	2.10E-05	2.81E-05
Pd-67	Pd <sub>77</sub> Cu <sub>12</sub> Pt <sub>11</sub>	1.86E-05	2.49E-05	3.44E-05	4.44E-05	5.67E-05
Pd-74	Pd <sub>73</sub> Cu <sub>12</sub> Au <sub>15</sub>	3.74E-05	5.00E-05	5.94E-05	7.26E-05	8.99E-05
<i>Pd-95</i>	<i>Pd<sub>83</sub>Cu<sub>5</sub>Au<sub>12</sub></i>	<i>3.99E-05</i>	<i>5.35E-05</i>	<i>6.34E-05</i>	<i>7.74E-05</i>	<i>1.40E-04</i>
Pd-84	Pd <sub>94</sub> Ru <sub>6</sub>	4.12E-05	5.38E-05	6.47E-05	7.61E-05	9.43E-05
Pd-18	Pure Pd		7.83E-05	1.10E-04	1.07E-04	
Pd-46	Pd <sub>91</sub> Au <sub>9</sub>	7.88E-05	7.88E-05	1.20E-04	1.51E-04	1.70E-04
Pd-25	Pd <sub>85</sub> Ag <sub>15</sub>			1.35E-04		







# Normalized Theoretical & Experimental Permeability Data

Alloys in Atomic %	573 K	623 K	673 K	723 K	773 K
Pd (Expt.)	1	1	1	1	1
Pd <sub>96</sub> Au <sub>4</sub>	0.901776016	0.9151377	0.9266699	0.9367236	0.9455654
Pd <sub>96</sub> Ag <sub>4</sub>	1.659890697	1.5808838	1.5165873	1.4632854	1.4184067
Pd <sub>96</sub> Cu <sub>4</sub>	0.670206907	0.6918972	0.7109169	0.7277247	0.7426815
Pd <sub>94</sub> Ru <sub>6</sub> (Expt.)		0.6871009	0.5881818	0.711215	
Pd <sub>85</sub> Au <sub>15</sub> (Expt.)		1.0063857	1.0909091	1.411215	
Pd <sub>85</sub> Ag <sub>15</sub> (Expt.)			1.2272727		
Pd <sub>83</sub> Cu <sub>17</sub> (Expt.)		0.1328225	0.1418182	0.1962617	
Pd <sub>74</sub> Cu <sub>26</sub>	0.13590263	0.1585882	0.180864	0.2025528	0.2235432
Pd <sub>70</sub> Cu <sub>30</sub>	0.038067237	0.0490968	0.0609727	0.0734861	0.0864544
Pd <sub>77</sub> Cu <sub>3</sub> Au <sub>21</sub> (Expt.)		0.6832695	0.5763636	0.7233645	
Pd <sub>74</sub> Cu <sub>7</sub> Pt <sub>19</sub> (Expt.)		0.3180077	0.3127273	0.4149533	
Pd <sub>70</sub> Cu <sub>26</sub> Au <sub>4</sub>	0.135317913	0.1576417	0.1795283	0.2008101	0.2213829
Pd <sub>70</sub> Cu <sub>26</sub> Ag <sub>4</sub>	0.118695486	0.1379764	0.1568419	0.1751544	0.1928306
Pd <sub>70</sub> Cu <sub>26</sub> Pt <sub>4</sub>	0.096406028	0.1149923	0.1336154	0.1520646	0.1701896
Pd <sub>68</sub> Cu <sub>7</sub> Pt <sub>26</sub> (Expt.)		0.6385696	0.54	0.6785047	