

# Membrane/Electrolyzer Development in the Cu-Cl Thermochemical Cycle

**Michele Lewis**

**M. Ferrandon, S. Niyogi, S. Ahmed, Argonne National Laboratory**

**C. Fan, Gas Technology Institute**

**R. Sharna, M. Fedkin, M. Hickner, S. Lvov, Pennsylvania State University**

**D. Tatterson, Orion Consulting Group**

**L. Nitsche, L. Wedgewood, University of Illinois - Chicago**

Presented at the 2011 Hydrogen Program Annual Merit Review Meeting  
Arlington VA, May 12, 2011

Project ID: PD013

This presentation does not contain any proprietary, confidential, or otherwise restricted information



# Overview

## Time Line

- Project Start: 10/06
- Project End: 10/2011\*
- % complete: 30%

## Budget

- \$100 K for FY09
- \$550 K for FY10
- \$600 K for FY11

## Barriers

- G. Capital Cost
- H. Efficiency
- AU. High temperature thermochemical technology

## Partners/Collaborators

- Information exchange
  - Atomic Energy of Canada Ltd (AECL) and University of Ontario Institute of Technology (UOIT) and 5 other Canadian universities

\*Project continuation and direction determined annually by DOE



# Relevance to DOE mission

- Objective: Develop a commercially viable process for producing hydrogen that meets DOE cost and efficiency targets using the Cu-Cl thermochemical cycle

- 3 major reactions in cycle

- **Hydrolysis**

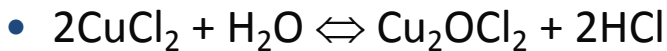

- **Oxychloride decomposition**

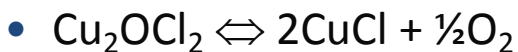

- **Electrolysis** (simplified)

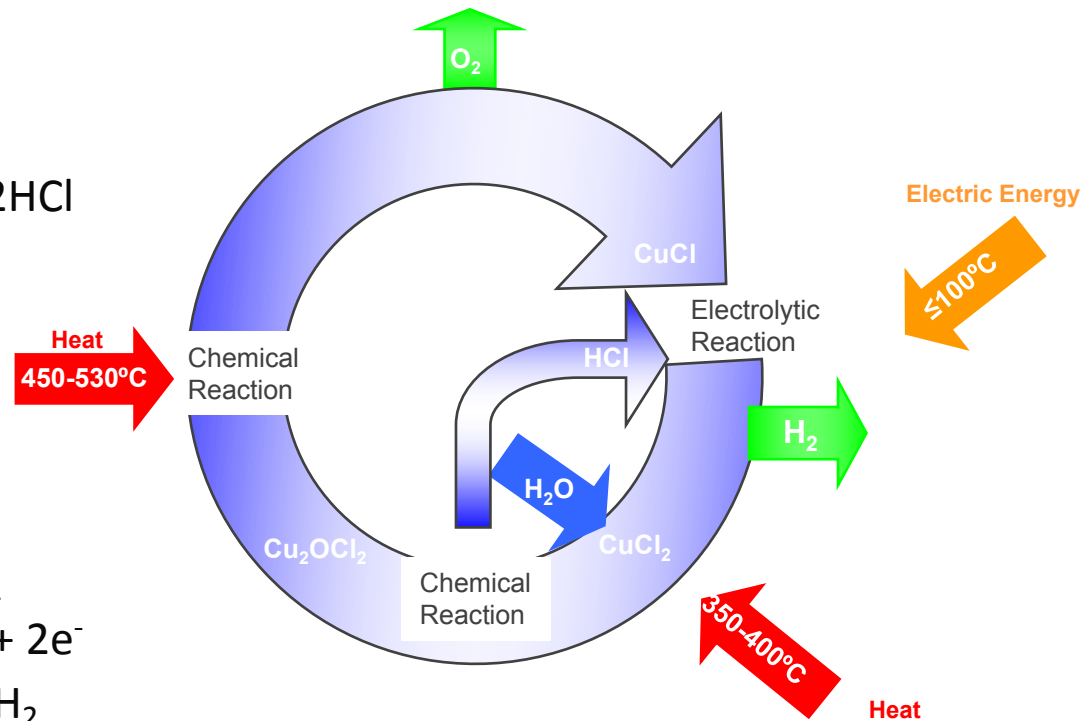
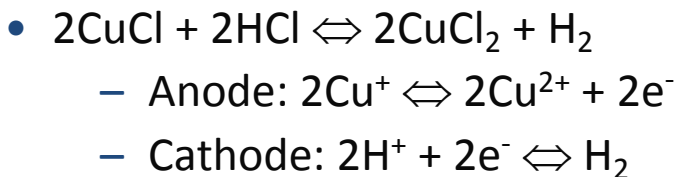

# Relevance to DOE mission

- Features of cycle that promote meeting targets and overcoming barriers
  - The 550C maximum temperature allows coupling with the solar power tower, which is near commercialization
  - Conceptual design uses commercially practiced processes
  - High yields in thermal reactions; no catalysts required
- Process designed to store solar energy as hydrogen



# Approach - Definition of the critical path

- 2011 Go/no go decision point: Reduce copper permeation across the membrane
  - Milestone (Sept, 2011): Develop membranes that reduce copper crossover to 10% that of Nafion<sup>®</sup> at 80C. **Status:** 2 membranes identified with Cu diffusivity <10% of Nafion<sup>®</sup> and chemically and thermally stable at 80 C for over 40 hours.
- Develop ASPEN flowsheet capable of meeting hydrogen production cost targets of \$5-6/kg for 2015 and \$2-3/kg for 2020
  - Projected H<sub>2</sub> production costs: \$6.83/kg (2015); \$5.39/kg (2025)
  - Several concepts are now being studied to improve efficiency from 30% (LHV) and decrease production cost
- Achieve stable long term performance of electrolyzer
  - Milestone (2012): Optimize design to reach target: 0.6-0.7 V, 0.5 A/cm<sup>2</sup> and a membrane or membrane electrode assembly (MEA) lifetime of at least a week
    - **Status:** Stable performance for 36 h at 0.63V and 0.05 A/cm<sup>2</sup> at 80C achieved at PSU
- Identify materials of construction and continue collaboration with Canadian institutions

# Membrane development program

## ■ Targets

- Copper permeability is 10% or less compared to Nafion<sup>®</sup>'s permeability
- Sufficient proton conductivity
- High selectivity (proton conductivity/Cu permeability)

## ■ Several types of materials

- Modified Nafion<sup>®</sup>
- Polysulfone
- Commercially available membranes or separators

## ■ Testing Program

- Permeability at 80C in various solutions
  - Screening tests in 1M CuCl<sub>2</sub> in 10.2M HCl (solute-rich side) and either H<sub>2</sub>O or 10.2M HCl (solvent-rich side)
  - Optimization tests to be conducted in various HCl solutions of Cu(I) and Cu(II)
- Conductivity
- Electrolyzer tests



# Potential membrane materials

## ■ Modified Nafion<sup>®</sup> membranes

- Case 1: Addition of polymeric matrices that intertwine around the Nafion<sup>®</sup> chains with added sulfonic groups (S. Niyogi at Argonne National Laboratory (ANL))
- Case 2: Addition of inorganic additives (S. Lvov at Pennsylvania State University (PSU))
- Case 3: Various pretreatments

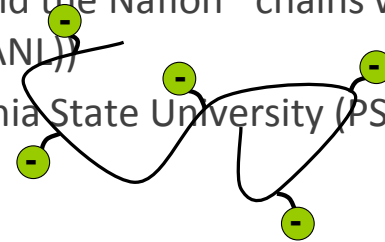

## ■ Polysulfone and cross-linked polysulfone membranes

- Radel NT-5500, a commercially-available polymer from Solvay Advanced Polymers; commercial price ~ \$20/kg for small lots;
- Early tests showed low Cu permeability but in Canadian electrolyzer tests, the copper crossover was higher than with Nafion<sup>®</sup>
- New crosslinked polymers designed by m. Hickner at PSU to further mitigate copper crossover

## ■ Commercial membranes or separators (treated and untreated)

- Membranes obtained from Gas Technology Institute (GTI) are commercial products from vendors who define their properties as low metal ion crossover, high mechanical strength, long lifetime, stable under highly oxidative and reductive conditions and about \$1 or so /sq. ft.
- Testing ongoing at ANL, GTI, and PSU

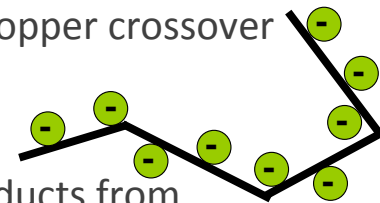

# Screening test results for membrane evaluation: permeability





# CuCl<sub>2</sub> permeability in a diffusion cell

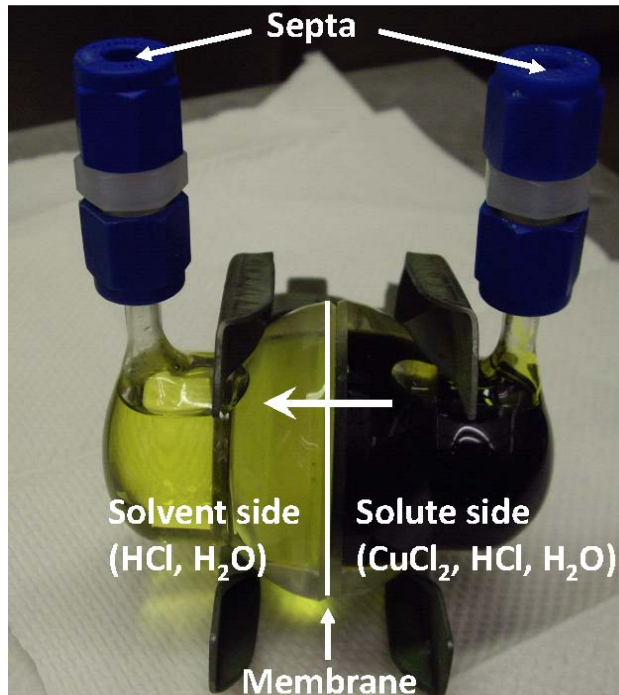

- Solute-rich side is 1 M CuCl<sub>2</sub> in 10.2 M HCl; solvent-rich side is typically 10.2 M HCl
- Sample (0.5 mL) each compartment to equilibrate the liquid pressure on both sides every hour (for at least 8h)
- Only solvent-rich side samples are analyzed by UV-Vis for CuCl<sub>2</sub> concentration (up to 1000 ppm)

Use a test chamber to keep the cell at 80 °C. An Ar purge and vent lines are used to avoid accumulation of HCl in the glass container



# Results of permeability measurements at 80C, 10 M HCl

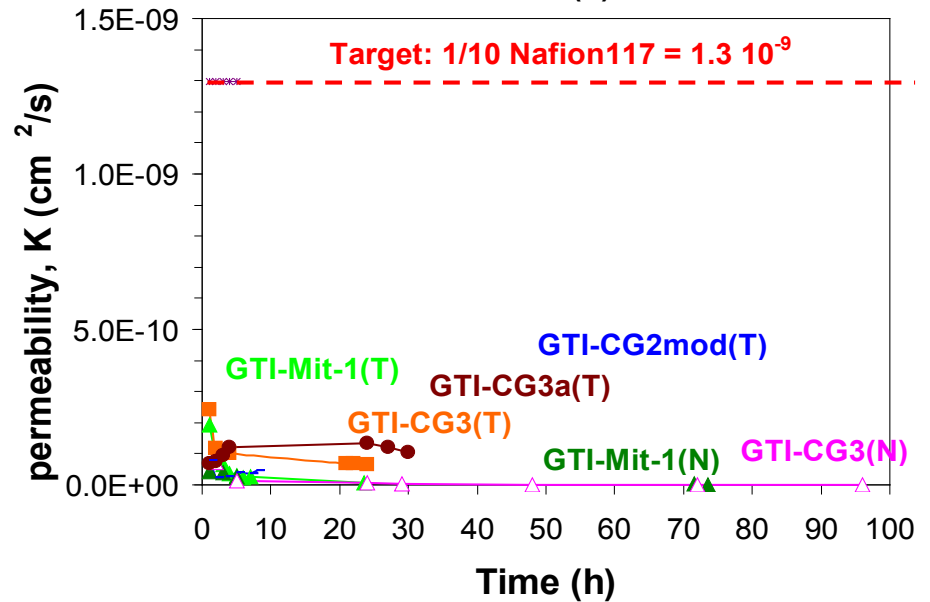
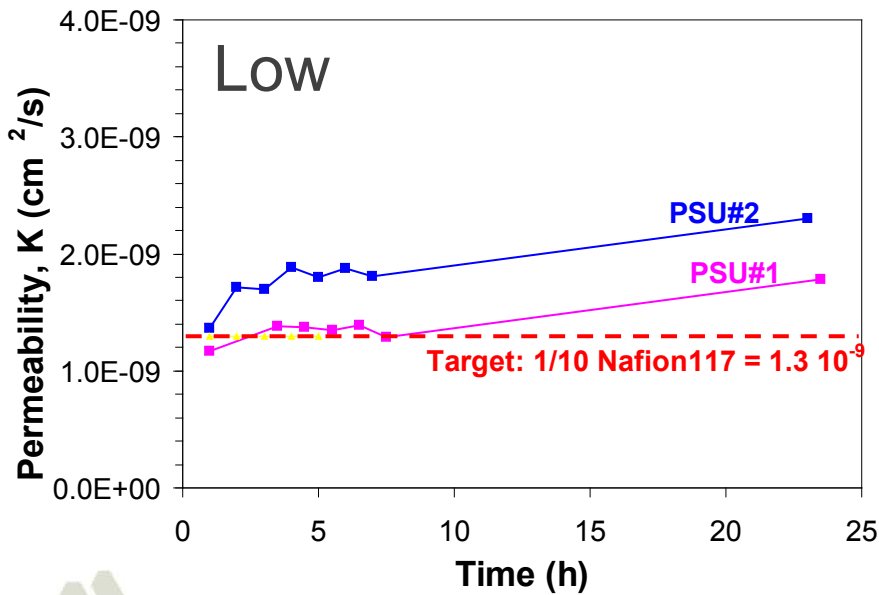
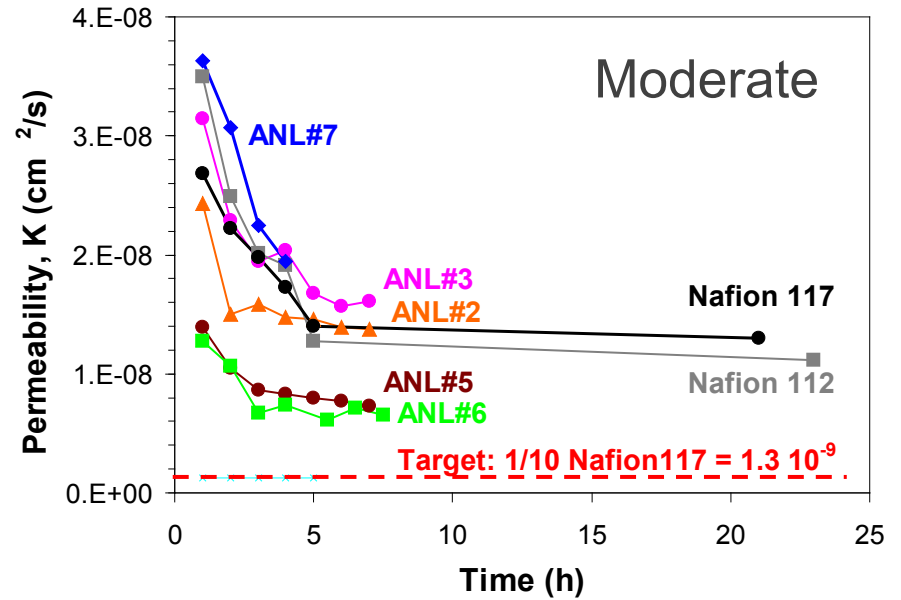
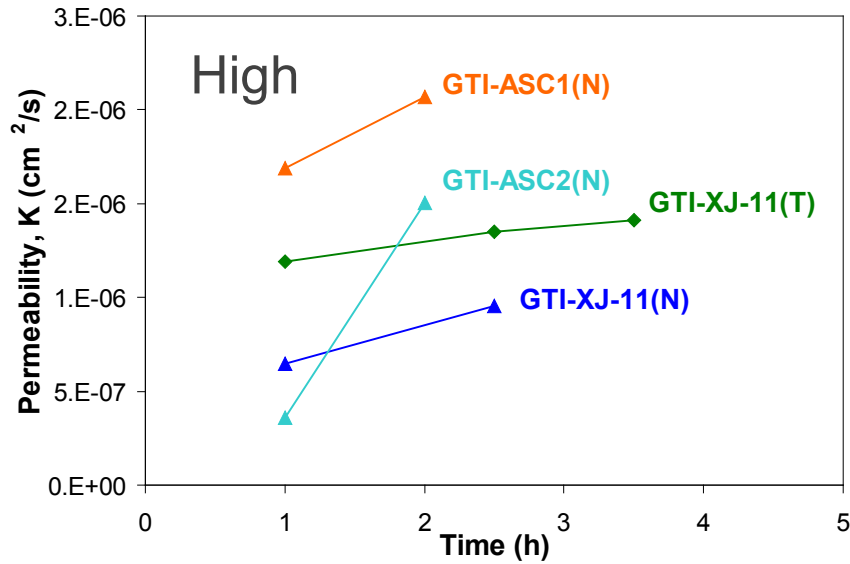

# Latest permeability test results

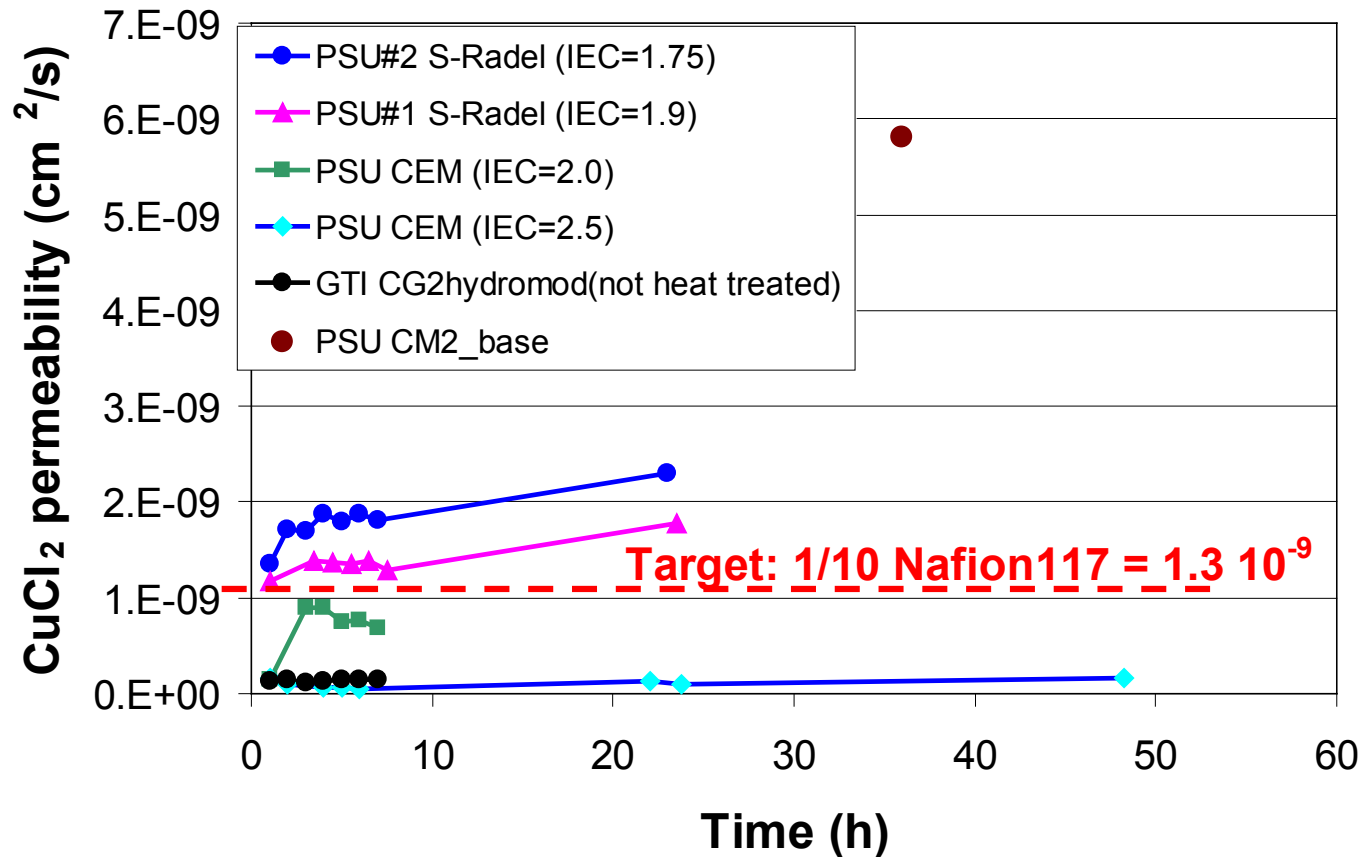

Low Cu(II) permeability is necessary but may not be sufficient

**Screening test results for membrane evaluation:  
proton conductivity**



# Through-plane conductivity results at 20C

- Membranes were pretreated and tested in 2 M HCl
- Conductivity =  $\delta/R \times A$ , where  $\delta$  = thickness of wet membrane, R is the membrane resistance and A is the exposed surface area

Membrane	Thickness, cm	Conductivity, S/cm
Nafion 117	0.018	0.084
CM2_base	0.35	0.083
Commercial MEAs	0.019	0.061
Nafion 117	0.020	0.097
GTI-MIT	0.003	<b>Inconclusive</b>
GTI-CG2	0.003	0.0055

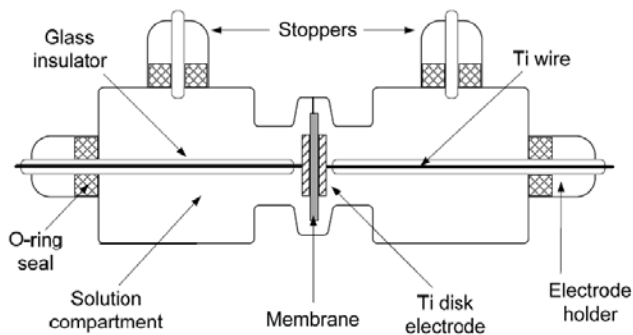

# Selectivity used to identify 'best' membranes

- Selectivity is proton conductivity/Cu(II) permeability
- These membranes have higher selectivity than Nafion®

Membrane	Thickness, cm	Conductivity S/cm, $\sigma$	Permeability cm <sup>2</sup> /s, K	Selectivity* S·s/cm <sup>3</sup> , $\sigma/K$
Nafion 117	0.020	0.0840	$4.6 \times 10^{-7}$	<b><math>1.8 \times 10^5</math></b>
GTI- CG2	0.003	0.0054	$9.4 \times 10^{-10}$	<b><math>57 \times 10^5</math></b>
PSU CEM (IEC= 2.0)	0.01	0.038	$2.1 \times 10^{-8}$	<b><math>18 \times 10^5</math></b>
PSU-CM2	0.035	0.083	$5.8 \times 10^{-9}$	<b><math>143 \times 10^5</math></b>

\* Selectivity after 20-36 hours

# Electrolysis: reaction, equipment and results

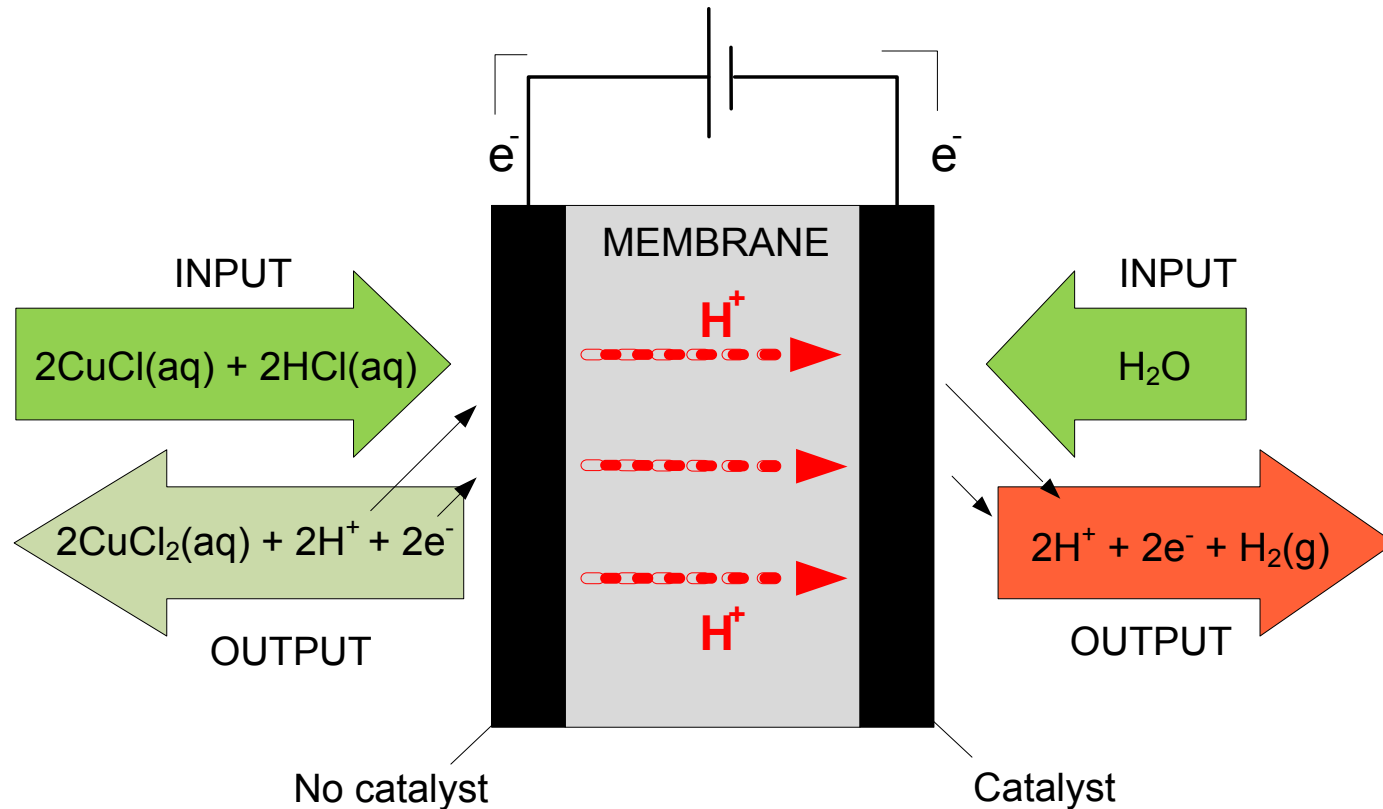

# Electrolyzers at Penn State and GTI operate at 80C;

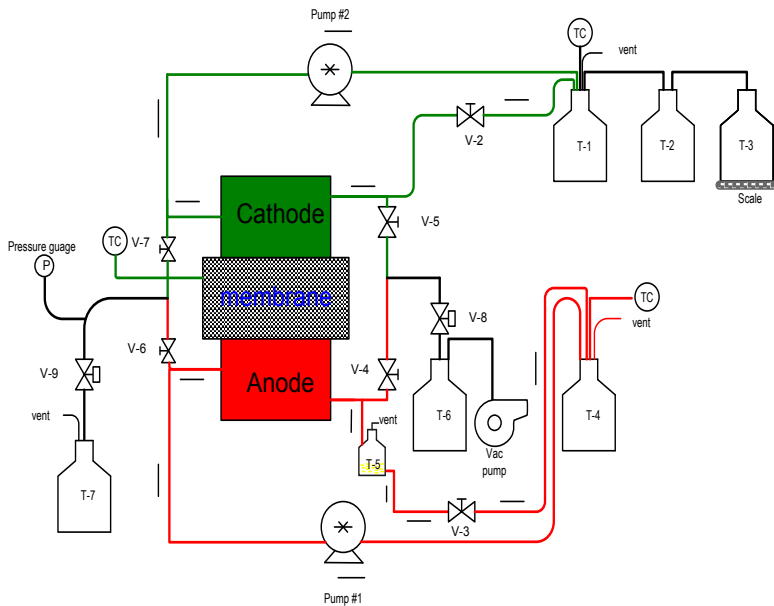



# H<sub>2</sub> production-a measure of electrolyzer performance

- The rates of hydrogen production remained quite stable over 36 hours of electrolysis
- Almost no copper deposition was found at the cathode of the CM2 sample after 36 hours of electrolysis experiment.

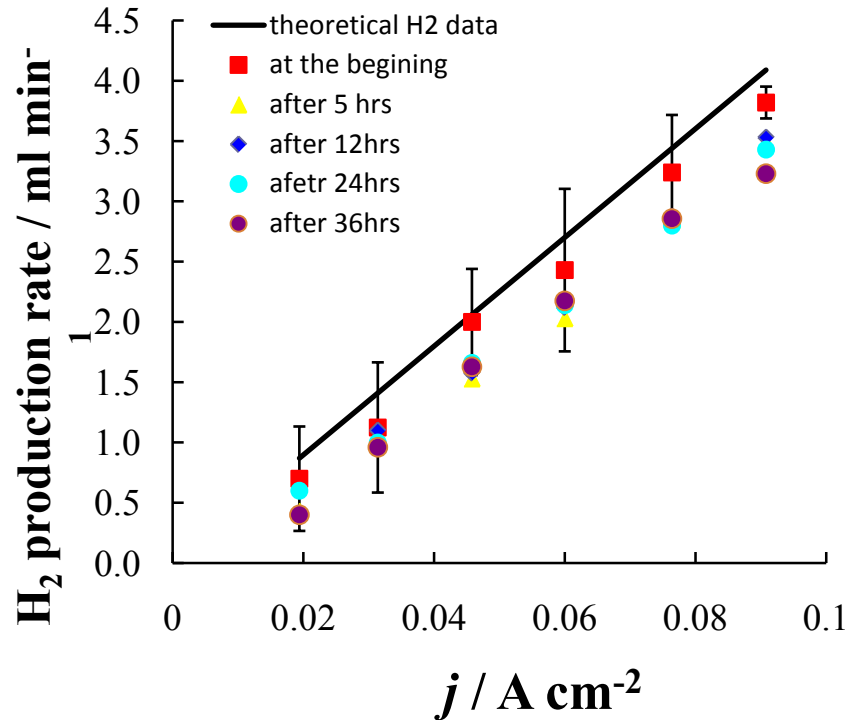

- However, experimental results have not been reproducible

**Aspen model used to determine cycle efficiency, which is strongly dependent on the amount of steam in the hydrolysis reaction,  $2\text{CuCl}_2 + \text{H}_2\text{O} \rightarrow 2\text{Cu}_2\text{OCl}_2 + 2\text{HCl}$ :**

# Ongoing revisions to Aspen model

- **Initial Aspen model was reviewed**
  - Errors have now been corrected resulting in significantly lower efficiency due to excess steam requirements
- **New thermodynamic data were reported,  $\Delta$  in figure on right**
  - If correct, the amount of steam required is lower
- **X-ray absorption (XANES) study supports the lower steam requirement associated with new thermodynamic data**

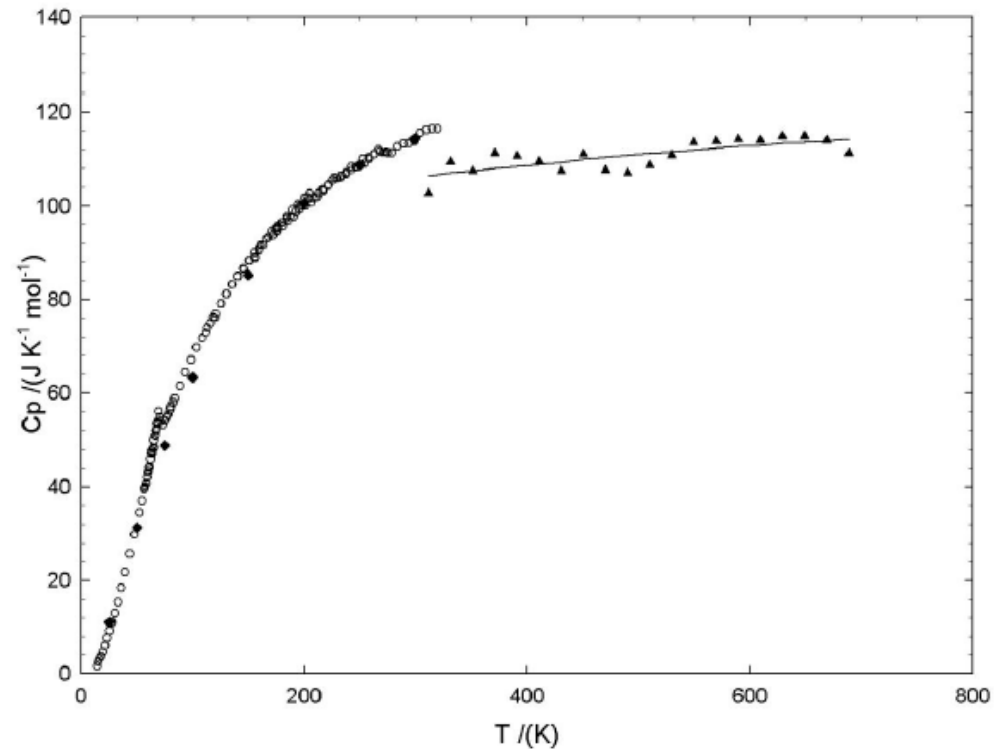

Circles and diamonds represent  $C_p$  data from adiabatic calorimeter studies of solids; triangles represent data from solution reaction studies

# XANES studies at the Advanced Photon Source to obtain mechanistic information for the hydrolysis reaction of $\text{CuCl}_2$

## Standards' spectra

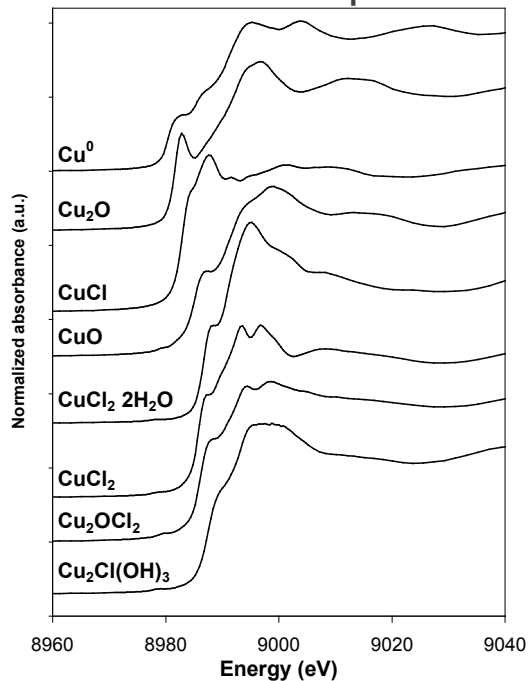

## Fitted spectrum

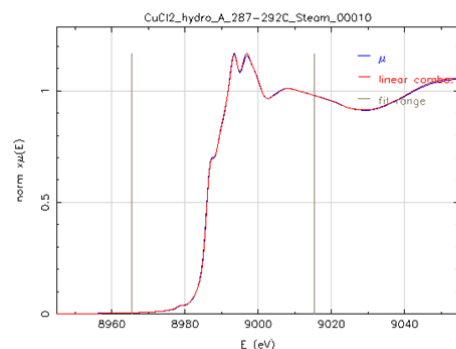

## Fraction of Cu during hydrolysis v.s. temperature

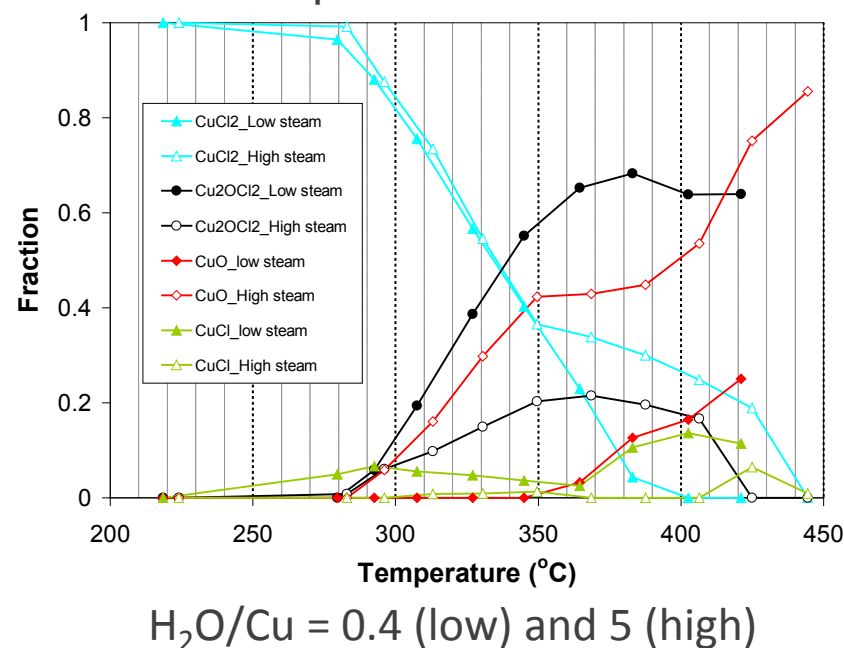

- Results for the hydrolysis reaction suggest the following:
  - Less excess steam needed
  - Maximum yield of  $\text{Cu}_2\text{OCl}_2$  should be obtained at lower temperature than current model predicts
  - Experiments to be repeated because of air contamination



# Some results from Canadian collaboration

- Large laboratory scale equipment has been built and is now being tested
  - $\text{Cu}_2\text{OCl}_2$  decomposition reactor is functioning at test temperature
- Ceramic carbon electrodes outperform graphite plates
  - Fuel cell testing is ongoing at University of Ontario Institute of Technology
- Molecular models for  $\text{CuCl}$  and  $\text{CuCl}_2$  are being developed so that the theoretical solubility can be calculated
- Raman and other spectroscopic techniques are being developed to identify the predominant chlorocopper complexes as a function of  $\text{HCl}$  concentration
- Aspen modeling is ongoing
- Corrosion resistance of various coatings for  $\text{CuCl}$  is being investigated



# Future work

- **Permeability, conductivity and selectivity as screening methods**
  - New work examines the effect of mixed Cu(I) and Cu(II) solutions in varying HCl concentrations
- **Electrolysis**
  - Understand how Cu crossover is affected by:
    - Membrane characteristics (pore size, water swelling, thickness, protons conductivity, permeability, etc.)
    - Operating conditions (temperature, compositions of anolyte and catholyte as a function of time, or concentrations of CuCl, CuCl<sub>2</sub>, HCl or H<sub>2</sub>O, and potential)
- **Aspen modeling and hydrolysis reaction studies**
  - General Users Proposal submitted to the Advanced Photon Source to determine steam requirements and to support revisions to Aspen model
- **Development of a materials of construction program**



# Summary

- **Three different types of membranes are being investigated**
- **Screening tests include permeability, conductivity, and selectivity**
  - Two membranes, separator CG2 and crosslinked polysulfone CEM (IEC= 2.0) meet permeability target
  - Three membranes, separator CG2 and crosslinked polysulfone. CEM (IEC= 2.0), and modified Nafion<sup>®</sup>, CM2, have higher selectivity than Nafion<sup>®</sup>
- **Electrolysis tests provide the final assessment ; work is in progress**
  - New electrolyzers operate at 80 C at Penn State & Gas Technology Institute
  - Penn State reports stable operation with a CM2 membrane for 36 hours with H<sub>2</sub> production in reasonable agreement with Faraday's Law; GTI reports operation at 0.7 V and 250 mA/cm<sup>2</sup> with CG2 but no lifetime data yet
  - Fabrication of MEAs is difficult
- **Aspen model**
  - Model is now being revised to reflect new thermodynamic data and data from the Xanes study of the hydrolysis reaction

# Collaborations

- Penn State University (PSU)
- Gas Technology Institute (GTI)
- Orion Consulting Group
- Atomic Energy of Canada Limited (AECL)
- University of Ontario Institute of Technology (UOIT), lead for the Cu-Cl cycle development program, funded by the Ontario Research Foundation and others





# Technical back-up slides



# Membranes based on Polysulfone

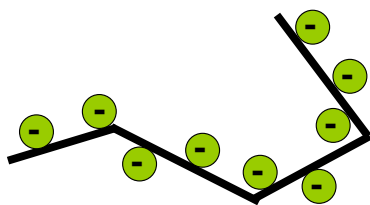
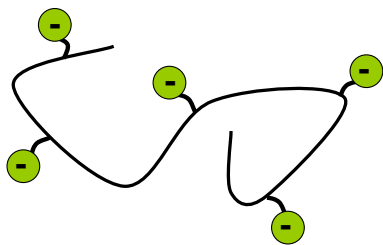

sulfonatedRadel<sup>®</sup> = sRadel

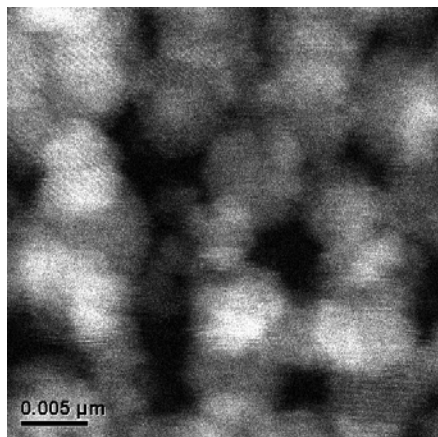
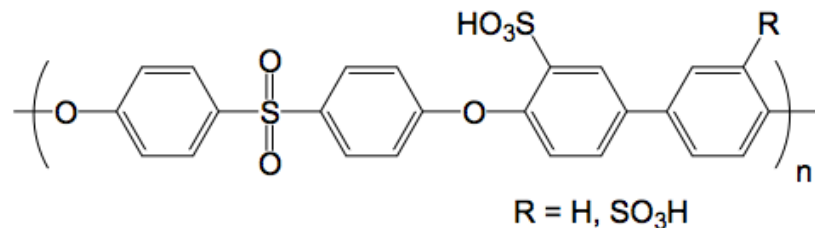

Nafion<sup>®</sup>  
0.91 meq g<sup>-1</sup>

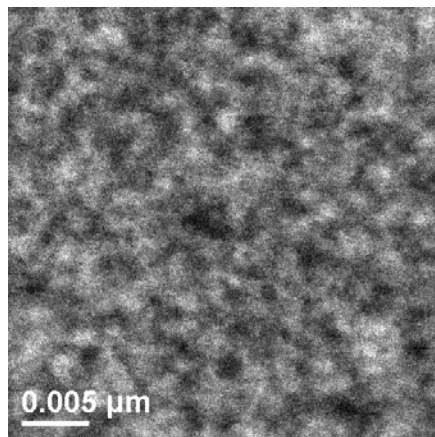

Sulfonated poly(phenylene)  
1.8 meq g<sup>-1</sup>

- Tunable properties for Cu crossover and water transport
- Small ionic domains (shown in white) suppress ion and small molecule diffusion and thereby provide higher selectivity
- But lower proton conductivity compared to Nafion (up to 0.2 S cm<sup>-1</sup>)

Hickner, et al., *Polymer* **2006**, 47, 4238.

# Measurements of Cu concentration via UV-Vis - CuCl<sub>2</sub> in 10.2M HCl

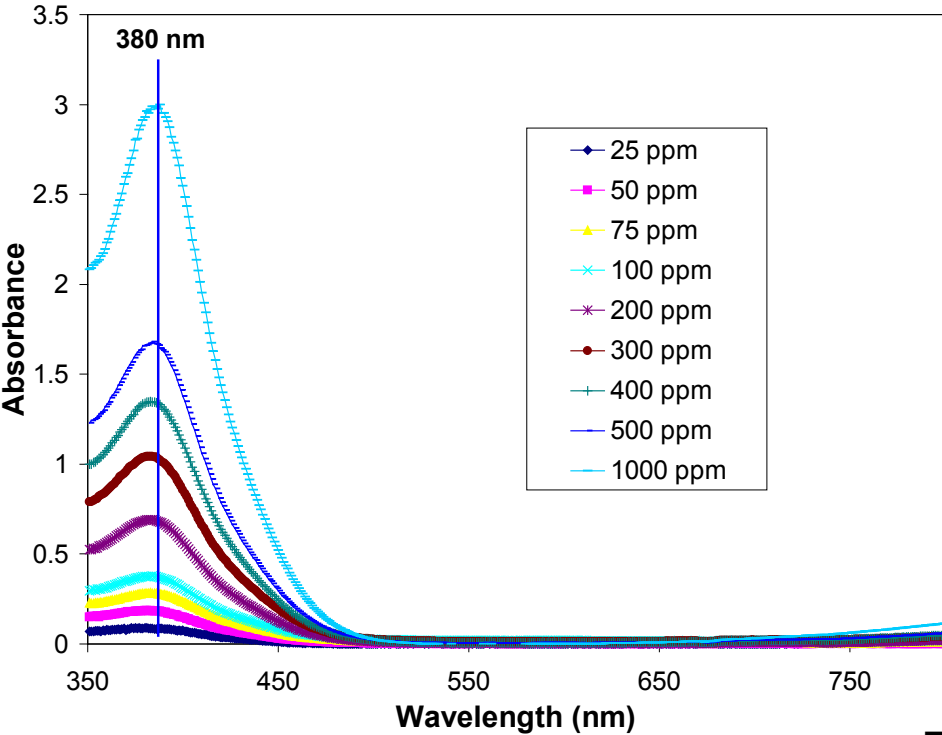

- The absorbance of the CuCl<sub>2</sub> can be measured in the visible range (350-800 nm).
- The maximum absorbance is at around 380 nm.

- The absorbance for solutions of CuCl<sub>2</sub> varies linearly (up to 500 ppm) with the molality (moles of CuCl<sub>2</sub> per kg of water)
- Signal is noise-free up to 1000 ppm

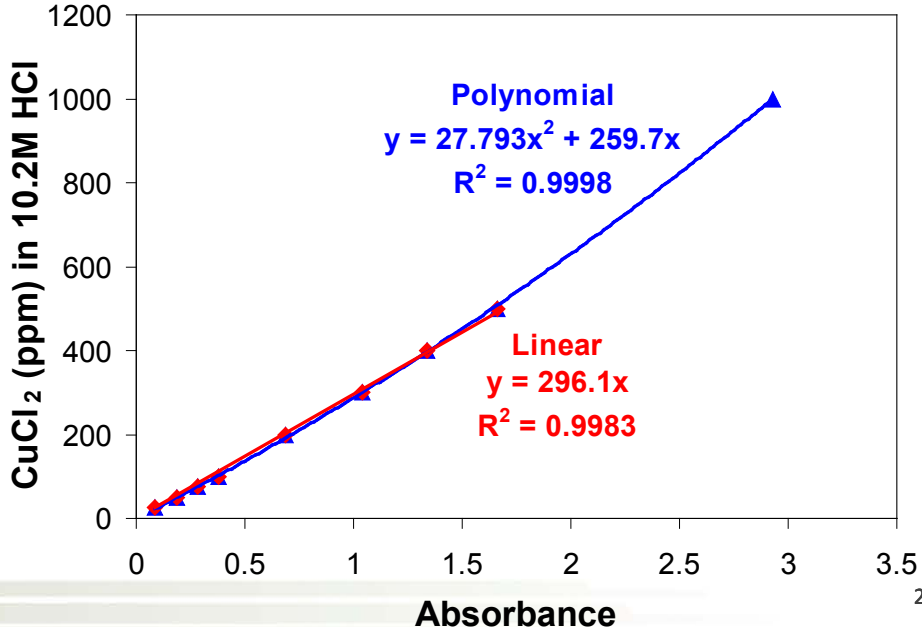

# Definition of permeability

- The permeability  $K$ , is calculated according to Zhou et al. [*Electrochimica Acta*, 48 (2003), 2173]:
- $K = IV(\text{sample})/A \cdot t \ln[C_1 - C_i / C_2 - C_i]$
- $l$ : thickness (hydrated 25°C),  $A$ : exposed area of membrane,  $V$  = volume of sample analyzed
- $C(\text{CuCl}_2)$ : concentration of  $\text{CuCl}_2$  in the solute-rich, assumed constant
- $C_1$ : concentration of  $\text{CuCl}_2$  in the solvent-rich side at time = 0, in these experiments, zero.
- $C_2$ : concentration of  $\text{CuCl}_2$  in the solvent-rich side at time  $t = t_{\text{exp}}$ .

# GTI's electrolyzer results with CG2

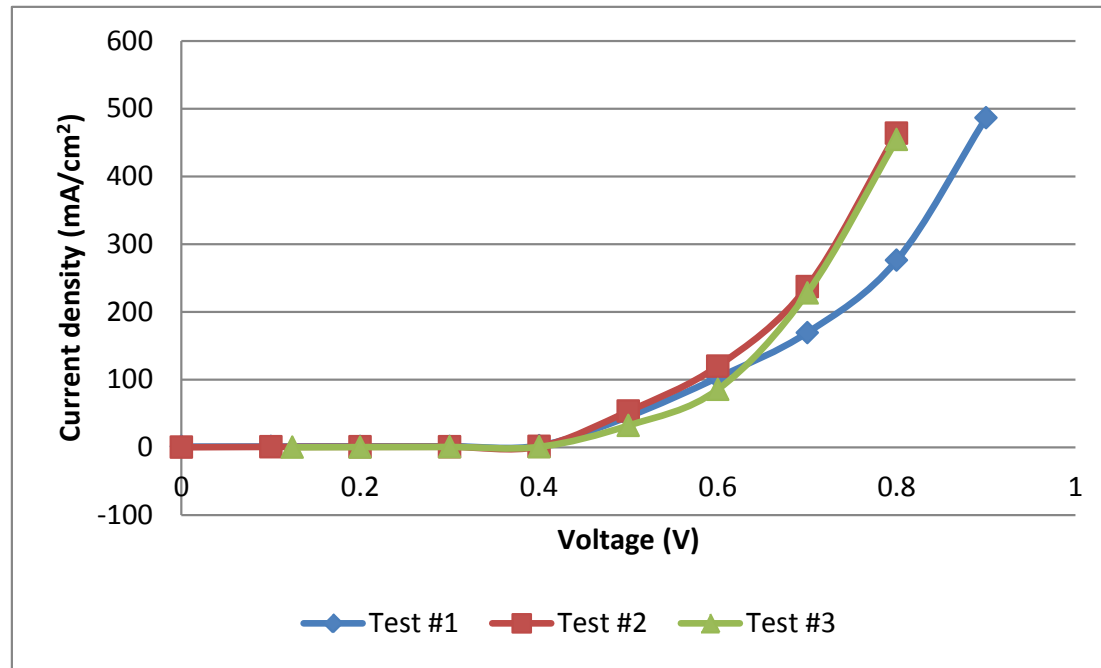

- 1 M CuCl in 10 M MHCl-anolyte, deionized water-catholyte