



Risk-Informed Safety Requirements for H2 Facilities

Jeffrey LaChance, William Houf, Greg Evans, and
Isaac Ekoto, Daniel Dedrick, Jay Keller

Sandia National Laboratories
May 11, 2011

Sandia is a multi-program laboratory operated by Sandia Corporation, a Lockheed Martin Company, for the United States
Department of Energy under contract DE-AC04-94AL85000

Project ID # SCS011

This presentation does not contain any proprietary, confidential, or otherwise restricted information

4/19/2011 9:42 PM



Overview

Timeline

- Project start date: 10/1/2003
- Project end date: 9/31/2015
- Percent complete: 70%

Budget

- Total project funding (to date)
- DOE share: \$420K
- FY10 Funding: \$0 (prior FY data reported under R&D for C&S)
- FY11 Planned Funding: \$420K

- Barriers addressed
 - Understanding of risk associated with hydrogen facilities
 - Provide risk-informed basis for development of uniform model codes and standards to
 - Harmonization of code requirements
 - Provide a safe infrastructure for the use of hydrogen
- Interactions/ collaborations:
 - Support for NFPA, ICC, and ISO
 - IEA Task 31 (Hydrogen Safety)
- Project lead: Jeff LaChance (SNL)



Objectives of hydrogen risk assessment activities

Safety and Risk

- *Safety is freedom from unacceptable risk*
- *Risk is a measure of safety*

*Risk=frequency*consequence*

Understand the risk associated with hydrogen facilities

- Provide a safe infrastructure for the use of hydrogen through risk management
- Provide risk-informed basis for development of uniform model codes and standards



We can't measure risk – we have to evaluate it using models:

- Models do not always address all contributors and failure mechanisms
- Data is often sparse
- Uncertainties can be large

Therefore, risk should be used in conjunction with other information when making decisions!



Approach for utilizing risk assessment in ensuring safety of hydrogen facilities

- Identification of the type and frequency of potential hydrogen releases
- Generate the experimental and analytical basis for evaluating the behavior and consequences of hydrogen releases
- Use of Quantitative Risk Assessment (QRA) to evaluate resulting risk, identify important risk drivers, and evaluate risk-reduction potential of accident prevention and mitigation features and actions
- Utilize risk insights to help establish code and standard requirements

What can go wrong?

What are the consequences?

Is the risk acceptable?

How can we reduce risk and increase safety?



Risk assessment milestones for FY11

Milestones

Successfully harmonized the risk-informed approaches used by ISO and NFPA in establishing separation distances for gaseous hydrogen facilities.

Evaluated the risk reduction potential of some accident mitigating features in support of NFPA task group examining the use of such features to reduce separation distances.

Currently performing risk assessment of indoor fuel cell vehicle operations in warehouses to support development of code requirements in NFPA and IC codes

Supporting NFPA-2 efforts to develop risk-informed separation distance tables for liquid hydrogen facilities. Current efforts have been on developing a liquid hydrogen release model.

Later this year, a proposed consensus hydrogen ignition probability model for use in QRA will be prepared utilizing available experimental information

Utilize data in the Technology Validation program to update hydrogen accident release frequencies being used in risk assessment work



Technical accomplishments in the development and application of risk assessment for hydrogen facilities



- Evaluation of risk-reduction potential of accident mitigation features
- Evaluation of risk associated with indoor refueling

- Expanded use and acceptance of QRA to establish risk-informed C&S requirements
- Harmonization of NFPA and ISO use of risk in establishing gaseous hydrogen facility separation distances

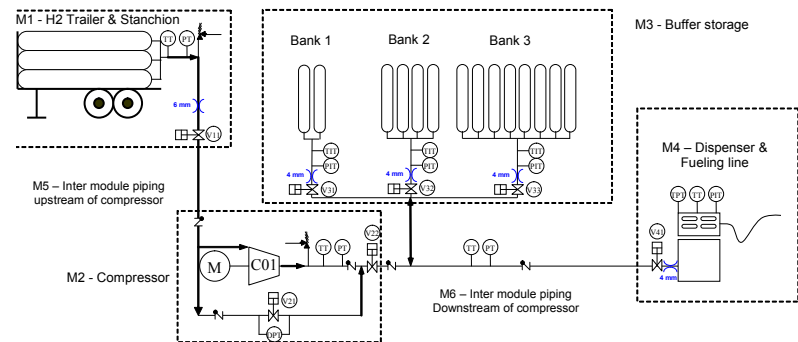

Harmonization of C&S requirements will allow international deployment of hydrogen

Under U.S. DOE sponsorship, Sandia is providing methods, data, models, and manpower to support harmonization of NFPA and ISO gaseous separation distances

Commonalities in approaches to determining separation distances:

- Both use same QRA approach (limited scope QRA)
- Same consequence models and component leak data

Differences that challenge harmonization of separation distances:

- Evaluated for different types of facilities: Bulk storage (NFPA) versus refueling facility (ISO)
- Different separation table format
- Different risk criteria
- Application of data is different

Common risk model

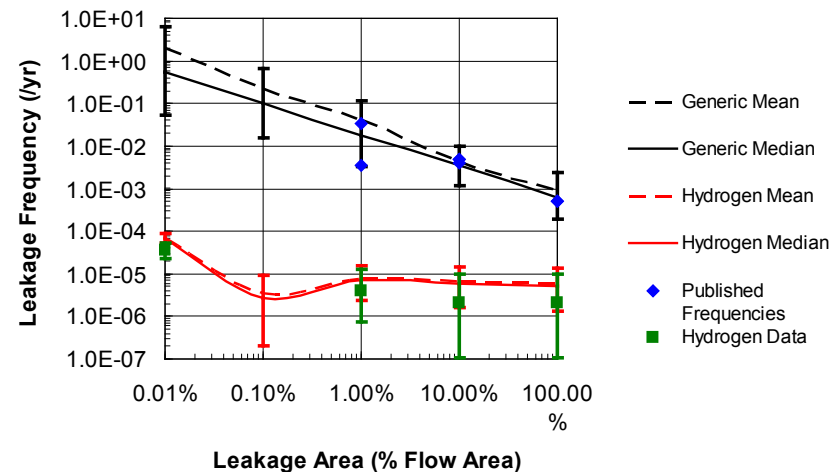
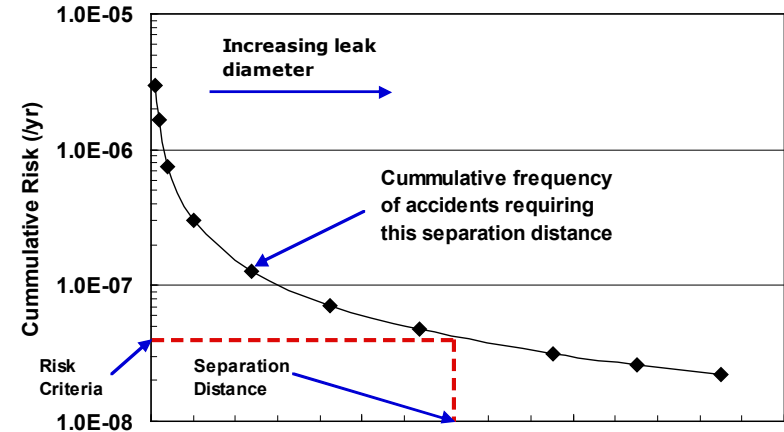

Important differences between the NFPA and ISO QRA is related to the application of data

- SNL-generated hydrogen component leak frequencies were modified for use in ISO QRA:
 - Linearized (on log-log scale)
 - Shifted an order of magnitude lower based on selected rebinning of a fraction of the generic leak frequencies into alternate bins

Hydrogen Release Rate (kg/s)	Immediate Ignition Probability	Delayed Ignition Probability	Total Ignition Probability
<0.125	0.008	0.004	0.012
0.125 – 6.25	0.053	0.027	0.08
>6.25	0.23	0.12	0.45

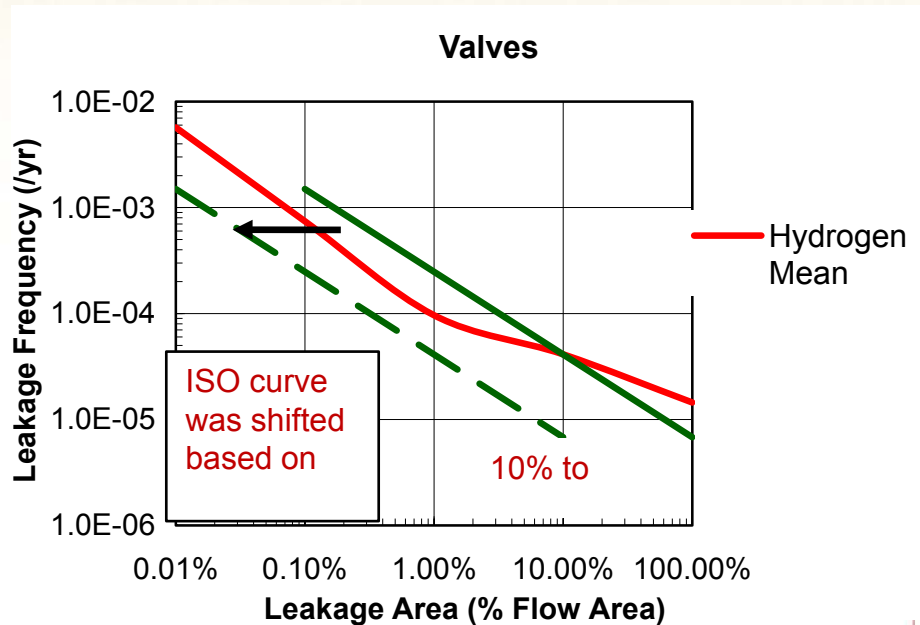

- NFPA QRA used ignition probability as function of hydrogen leak rate (see table)
- ISO QRA used probability of 0.04 for all leak sizes and did not differentiate between immediate and delayed ignition



Use of same data in ISO and NFPA QRAs provide consistent risk results

Total Risk - 15000 psig System

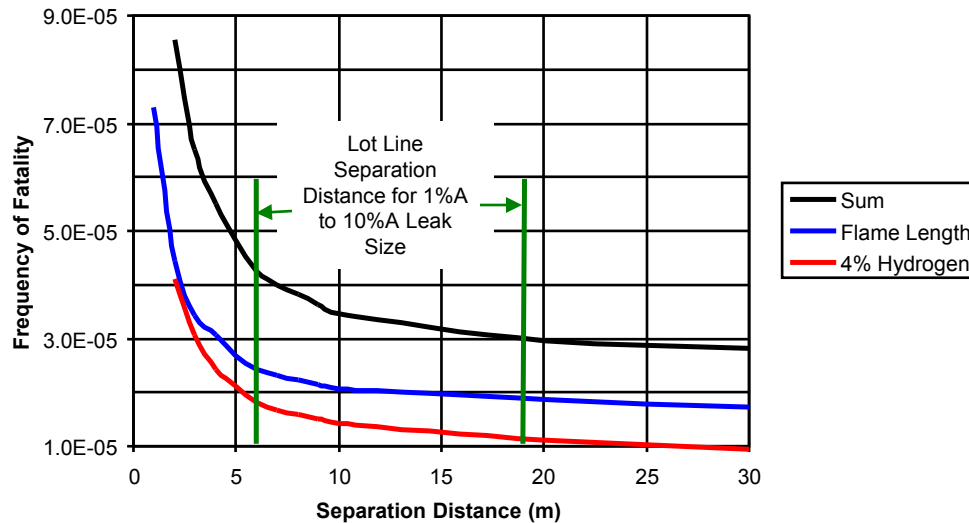

- Risk close to the “guideline” selected by NFPA 2 Task Group 6
- Risk from leaks greater than 3% of flow area were deemed acceptable
- Sensitivity study suggests that the risk associated with ISO separation distances is higher if the NFPA data is utilized and is consistent with the risk levels estimated in the NFPA QRA

More work is required to complete harmonization of the separation distances in the ISO and NFPA codes:

• Agree on example facility descriptions, risk criteria and use of data

• Use comparable table formats

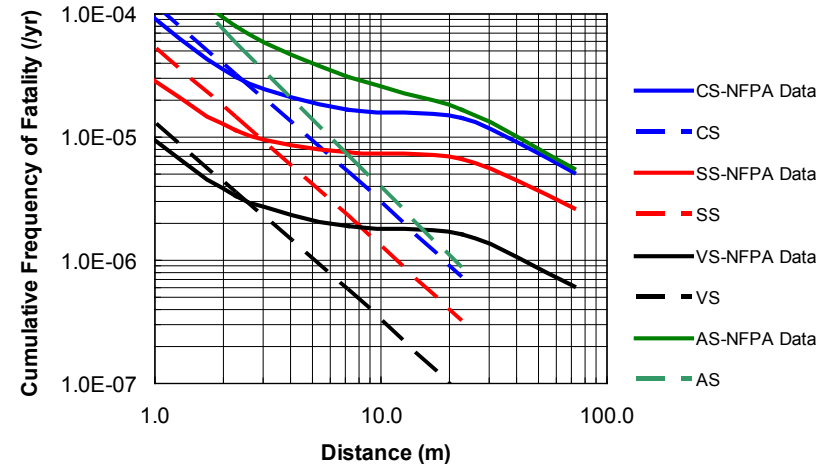

Risk from indoor refueling of forklifts is being evaluated to support NFPA 2 requirements

- Scaled experiments have been performed to validate computer models
- Representative refueling configurations have been generated for evaluating risk
- Data from Technology Validation program will be used in risk evaluation

Indoor Refueling of an H₂ Fuel Cell Forklift Vehicle



Frequency of significant releases from indoor refueling is expected to be low due to location of hydrogen storage systems outside and the use of safety interlocks

Model validation data produced from sub-scale warehouse tests

- Experiments have been performed to provide model validation data for full-scale FUEGO and FLACS simulations of hydrogen releases in warehouses.
- Experiments were performed in SRI International's scaled-warehouse facility.
- Scaled tests were designed using Froude scaling.
- Simulated Scenario: 0.8 kg hydrogen at 35 MPa released into a 1000 m³ volume through a 6.35 mm hole from forklift during refueling

Models are validated and are being used in risk assessment

Comparison of Simulation and Data for H₂ Concentration (with and without active ventilation)

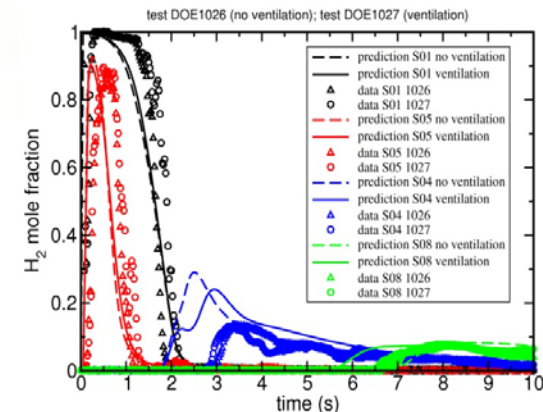

Comparison of Simulation and Data for Ign. Deflagration Overpressure

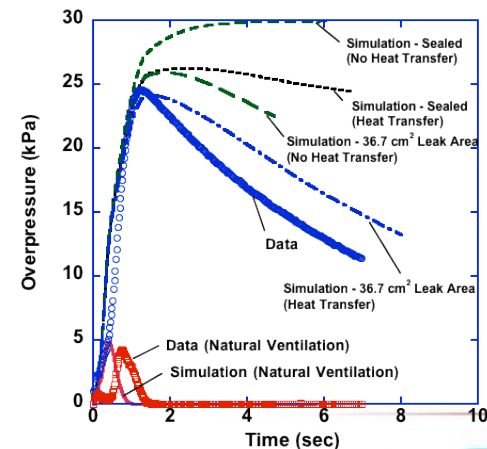

Accident mitigation features can be used to reduce risk and reduce separation distances

Risk-reduction potential evaluated for the following features:

- Active Detection and Isolation
 - Exterior detectors (hydrogen and flame)
 - Process flow detection (pressure and flow)
 - Excess flow valves
- Flow Limiting Orifices
- Reduction in Number of Components (leak reduction feature)
- Barriers

Example facilities used in evaluation

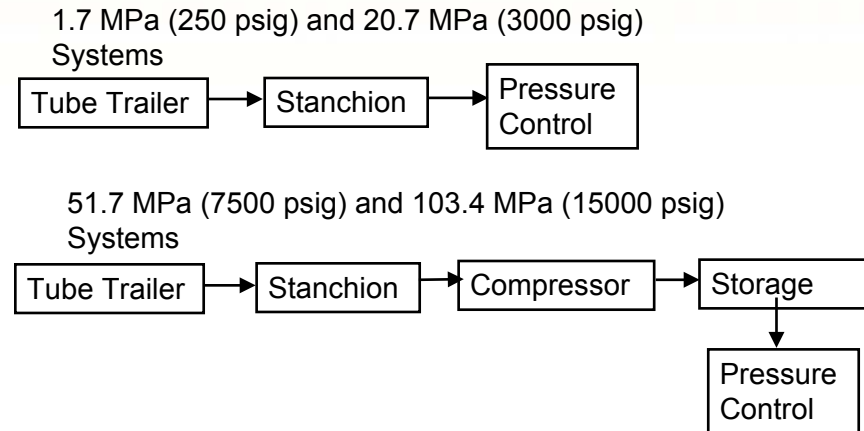

Accident sequence model

Component Leak	Immediate Ignition	Isolation	Delayed Ignition	End State
----------------	--------------------	-----------	------------------	-----------

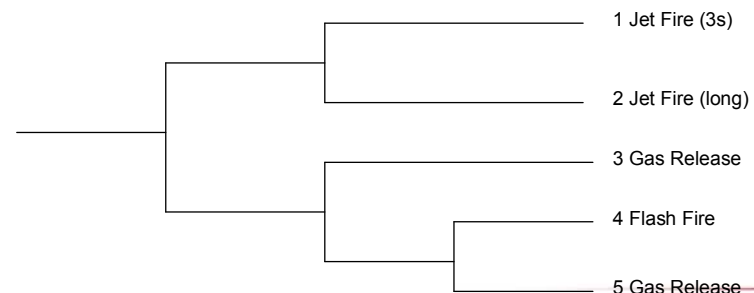

Mitigation features can reduce the frequency and consequences of accidents

Barrier walls will reduce the consequences from hydrogen jets if properly configured:

- Reduces unignited jet flammability envelope
- Deflects jet flames and protects from direct flame impingement
- Reduces thermal radiation exposure
- Do not introduce significant overpressure hazards

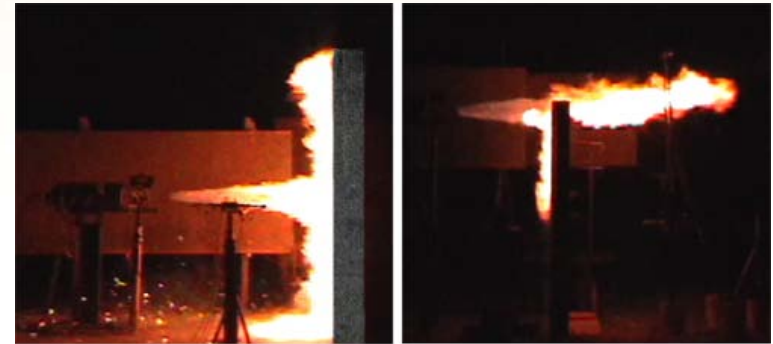
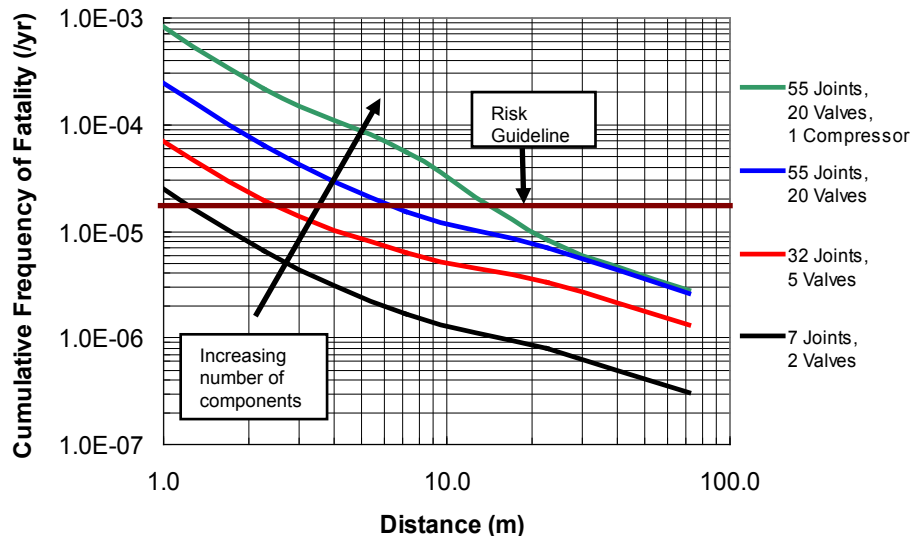

Reducing the number of high risk components (joints, valves, compressors, and hoses) in a system is effective in reducing the frequency of leaks and corresponding risk



Collaboration has been critical in performing risk assessment work

- SDOs (NFPA, ICC, and ISO) have defined needs with regard to C&S requirements to evaluate
 - Participation in task groups has led to consensus decisions on use of risk assessment results in establishing C&S requirements
- Example facilities used in risk assessment defined by industry representatives (Air Products and Air Liquide)
- Data for use in risk assessments obtained from industry (Air Products and Tech Validation program) data bases
- Presentation and review of work through conferences and journals provide critical peer review
- International collaboration through groups such as the International Energy Agency Task 19 on Hydrogen Safety helps in validating and harmonizing risk assessment methods, models, and data used throughout the world



Future work will evaluate risk for additional hydrogen facilities and forms of hydrogen

- In FY11
 - Generate accident frequency estimates using information from DOE's Technical Validation program
 - Develop hydrogen ignition model for use in QRA
 - Complete risk assessment of indoor refueling
 - Continue work on mitigation features
 - Evaluate risk associated with use of liquid hydrogen
 - Continue support of SDO initiatives
 - Represent DOE at International Energy Agency task group on hydrogen safety
- In FY12
 - Continue efforts to harmonize C&S in US and abroad
 - Evaluate the risk associated with use of hydrogen fuel cells as power sources for telecommunication towers
 - Evaluate risk of other portions of the hydrogen infrastructure
 - Evaluate risk associated with advanced hydrogen storage systems

Goal: enhance the safety of hydrogen facilities by using risk insights to identify cost-beneficial accident prevention and mitigation features. Utilize, as necessary, safety margins and a defense-in-depth concept to account for uncertainty in our current knowledge and modeling capability.



Summary of risk assessment achievements in FY11

- The risk assessment approach, models, and data used to establish NFPA-55 separation distances were applied by ISO
- Risk reduction potential of barriers was utilized to establish reduction factor for separation distances in NFPA-55
 - Additional mitigation features have been analyzed
- Preliminary work has been performed on evaluating the risk associated with indoor refueling
- Development of approaches, models, and data required in QRA continued
 - Experiments performed to understand phenomena, develop models, and bench mark consequence models
 - Analysis of additional data (event frequencies and ignition probabilities) used in QRAs



Backup Slides



A science-based, risk assessment approach has been adopted for hydrogen C&S development

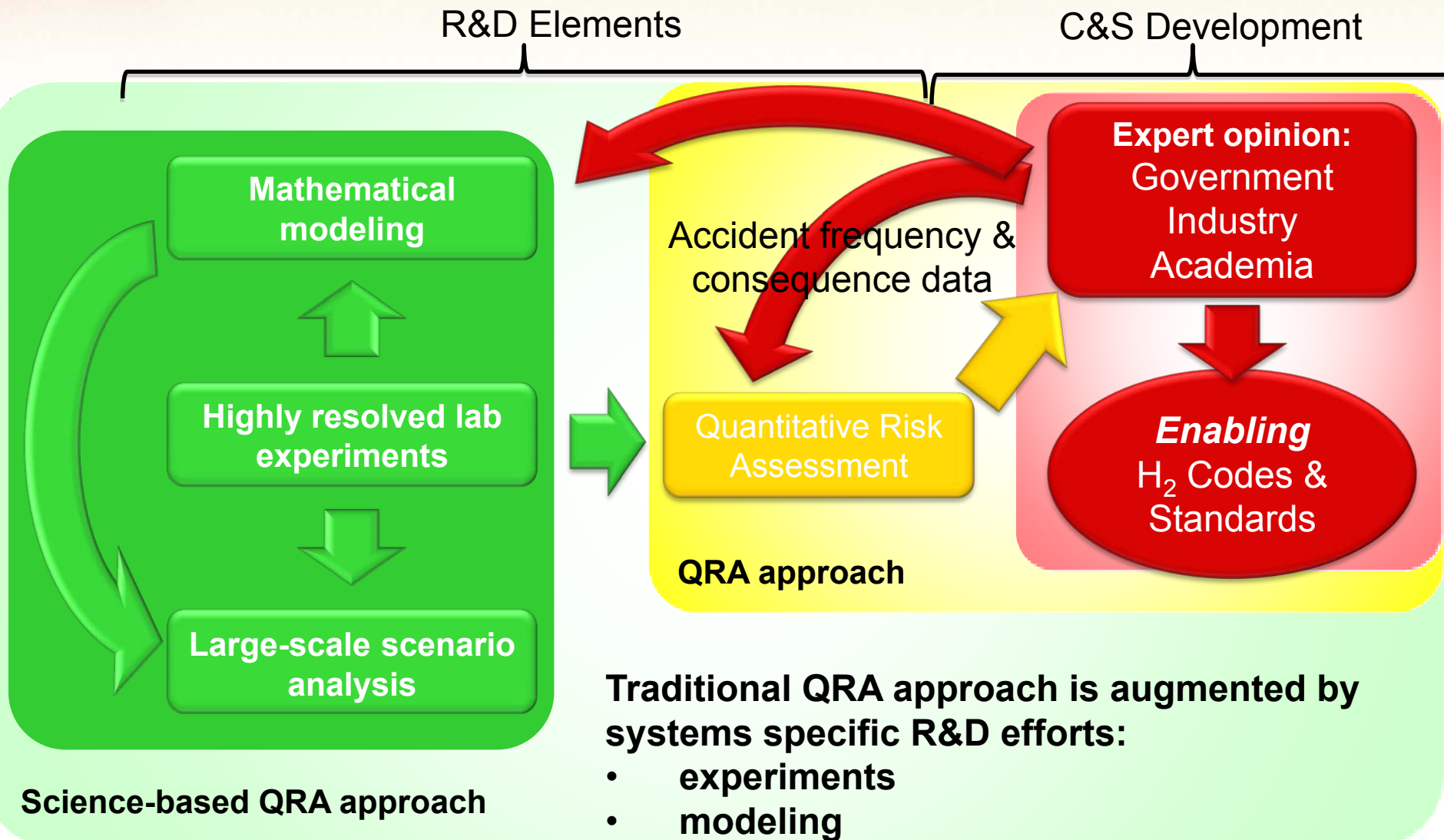

Comparison of NFPA and ISO leak sizes used in determining separation distances

Differences in ISO and NFPA leak sizes are due partly to difference in system descriptions

System Type	Example Systems	Leak Size (% of Flow Area)	
		Regular Exposure	Critical Exposure
ISO			
Very Simple Gas System (VS)	Pressure regulation module	0.03%	0.09%
Simple Gas system (S)	Cylinder pack	0.16%	0.48%
Complex Gas System (C)	Cascaded buffer storage system	0.42%	1.30%
Simple Large Storage System ¹ (SL)	Large hydrogen storage (e.g., 100 m ³)	0.38%	1.50%
Complex Large Storage System ¹ (CL)	Hydrogen tube trailer	0.75%	3.00%
Process System (A)	Compressor plus connections	0.65%	1.81%
NFPA	Bulk storage system with a hydrogen tube trailer, pressure regulator module, compressor, and buffer storage area	3.00% ²	

¹ The leak sizes for these systems were not evaluated using the ISO risk model. They were subjectively selected.

² The NFPA risk assessment used a single risk guideline of 2E-5/yr to evaluate leak sizes and resulting separation distances. This risk guideline is comparable to the regular exposure criteria of 1E-5/yr in the ISO risk assessment.



Test matrix examined effect of various parameters

- Ignition near release point provided higher overpressures than from ignition near the ceiling
- Blowout panels, vent openings, and the effective wall leakage area were effectively used to reduce the facility pressure.
- Over the time frame of the experiments, ventilation did not have an effect on the hydrogen concentration in the warehouse.

Infrared Video

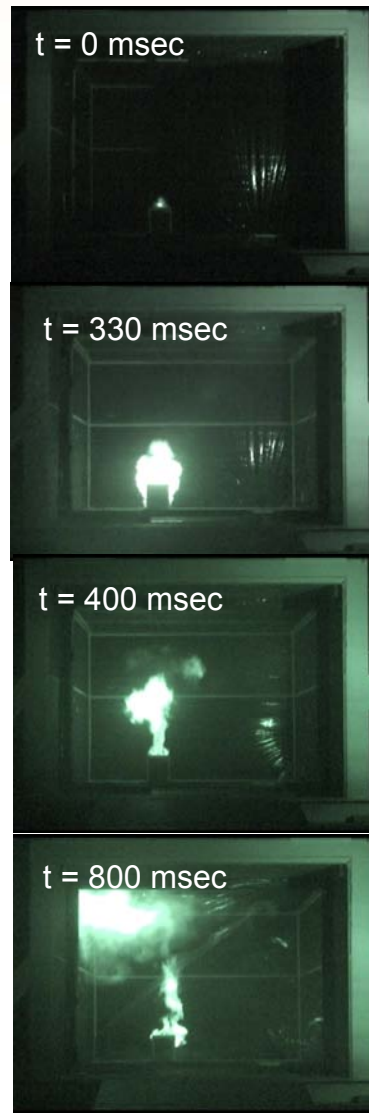

Effect of Ignition Location

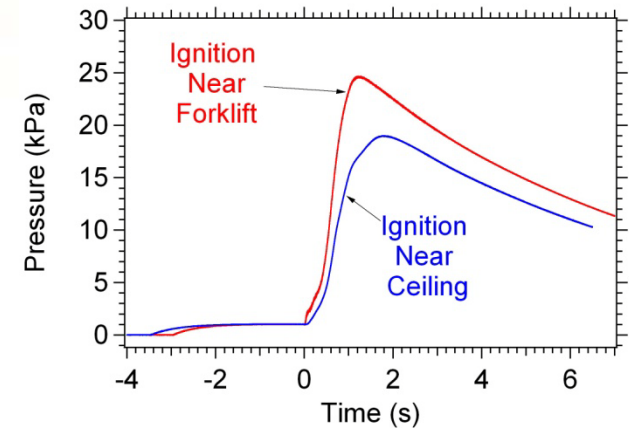

Use of Blowout Panels

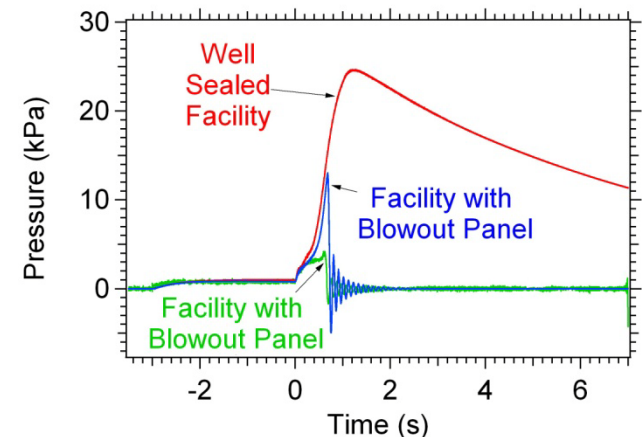

*Experiments performed at SRI
Corral Hollow Experiment Site (CHES)



Mitigation features can be used to reduce risk and reduce separation distances

