

Fuel Cell MEA Manufacturing R&D



**National Renewable Energy
Laboratory**

Michael Ulsh

May 15, 2013

MN001

This presentation does not contain any proprietary, confidential, or otherwise restricted information

Overview

Timeline

Start: July 2007

End: Project continuation and direction determined annually by DOE

% complete: N/A

Budget

Funding received in FY12

- \$619,000 (includes \$130,000 to partners)

Planned funding in FY13

- \$575,000 (includes \$160,000 to partners)

Barriers

Barriers	Target
E: Lack of Improved Methods of Final Inspection of MEAs	\$21/kW (2017) at 500,000 stacks/yr
K: Low Levels of Quality Control	

Funded Partners

Lawrence Berkeley National Laboratory
Colorado School of Mines
New Jersey Institute of Technology
DJW Technology

Relevance: NREL addresses most MYPP milestones

Task 6: Quality Control and Modeling and Simulation	
6.1	Develop continuous in-line measurement for PEM MEA fabrication. (4Q, 2012)
6.2	Develop defect detection techniques in pilot scale applications for manufacturing MEAs and MEA components. (4Q, 2013)
6.3	Establish models to predict the effect of manufacturing variations on MEA performance. (4Q, 2014)
6.4	Demonstrate methods to inspect full MEAs and cells prior to assembly into stacks (4Q, 2014)
6.5	Validate and extend models to predict the effect of manufacturing variations on MEA performance. (4Q, 2014)
6.6	Demonstrate continuous in-line measurement for MEA and MEA component fabrication. (4Q, 2015)
6.7	Develop methods to mark identified defects for later removal (4Q, 2015)
6.8	Develop and demonstrate techniques and diagnostics for automated or continuous in-line measurement of high temperature cells and sub-assemblies during fabrication. (4Q, 2016)
6.9	Develop correlations between manufacturing parameters and manufacturing variability, and performance and durability of MEAs (4Q, 2017)

Task 1: Membrane Electrode Assemblies
Develop continuous in-line measurement for MEA fabrication. (4Q, 2012)
Reduce the cost of manufacturing MEAs by 25%, relative to 2008 baseline of \$126/kW (at 1,000 units/year). (4Q, 2013)
Develop processes for direct coating of electrodes on membranes or gas diffusion media (4Q, 2014)
Develop processes for highly uniform continuous lamination of MEA components (4Q, 2014)
Develop cell manufacturing processes that increase throughput and efficiency and decrease complexity and waste (4Q, 2015)
Demonstrate processes for direct coating of electrodes on membranes or gas diffusion media (4Q, 2016)
Demonstrate processes for highly uniform continuous lamination of MEA components (4Q, 2016)
Develop fabrication and assembly processes for PEM fuel cell MEA components leading to an automotive fuel cell system that cost \$30/kW. (4Q, 2017)
Develop fabrication and assembly processes for membranes that operate at $T > 150^{\circ}\text{C}$ with a projected durability of 60,000 hours. (2Q, 2019)

Relevance: Cost of Poor Quality

- “Just four sequential process steps with 90% yields would increase costs by 30%...”

Debe, Nature, 486 (7 June 2012), pp. 43-51.

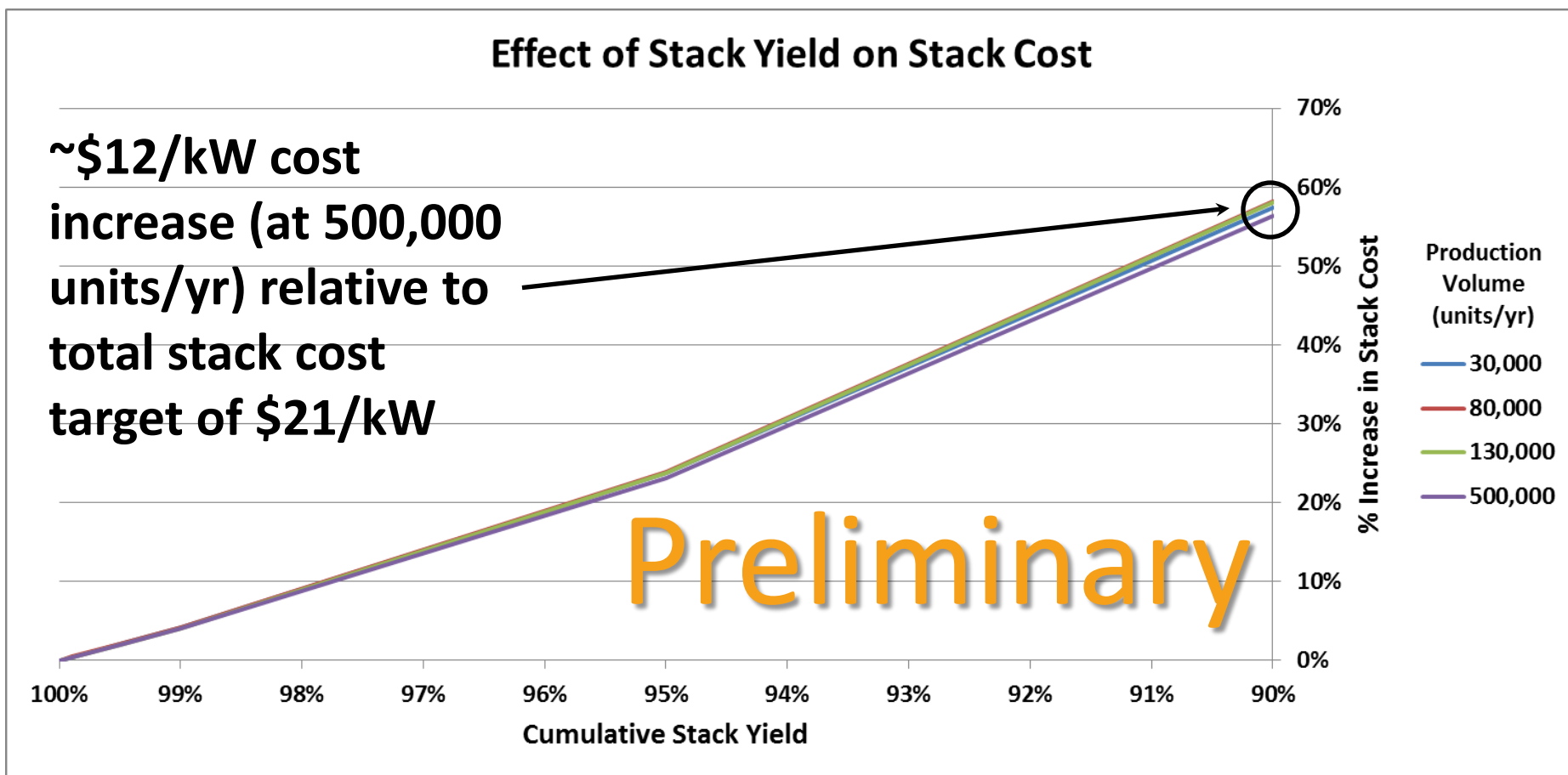

Preliminary Strategic Analysis Inc./NREL analysis using SA Inc's automotive fuel cell cost model, 2012.

Collaborations

- **W.L. Gore & Associates***, **BASF***, **Rensselaer***, **3M**, **Ion Power**, **Delphi**, **Ultra Electronics-AMI**, **Acumentrics**, **Proton OnSite**: prioritization of diagnostic development, defect selection, sample fabrication, support for DOE-funded manufacturing projects
- **NREL National Center for Photovoltaics/New Jersey Institute of Technology**: diagnostics development
- **Lawrence Berkeley National Lab**: model development and integration
- **Colorado School of Mines**: diagnostic development, test method development and defect analysis

** DOE Manufacturing projects*

Approach

- Understand quality control needs from industry partners and forums
- Develop diagnostics
 - Use modeling to guide development
 - Use in-situ testing to understand the effects of defects
- Validate diagnostics in-line
- Transfer technology

Date	Milestone/Deliverable	Complete
3/13	Prove feasibility of through-plane IR/DC using continuous sheet	100%*
6/13	Prove feasibility of optical reflectometry for detection of surface defects on SOFC tube cells	90%
8/13	Go/No-go decision on feasibility of implementing IR/RFT on web-line	75%

* Proved using CCM sheet

Approach: Prologue

- **Last year we focused on web-line demonstration**
- **This year we're focusing more on exploratory studies**
 - Improving sensitivity of current techniques
 - Expanding techniques to new materials
 - Exploring feasibility of new diagnostic concepts
 - Developing new in situ techniques/capabilities

- **Experimental electrodes with direct-coated ionomer**
 - From initial trials of Gore's DOE-funded process improvements
- **Difficult to measure black surfaces**
- **Inspection of surface structure**

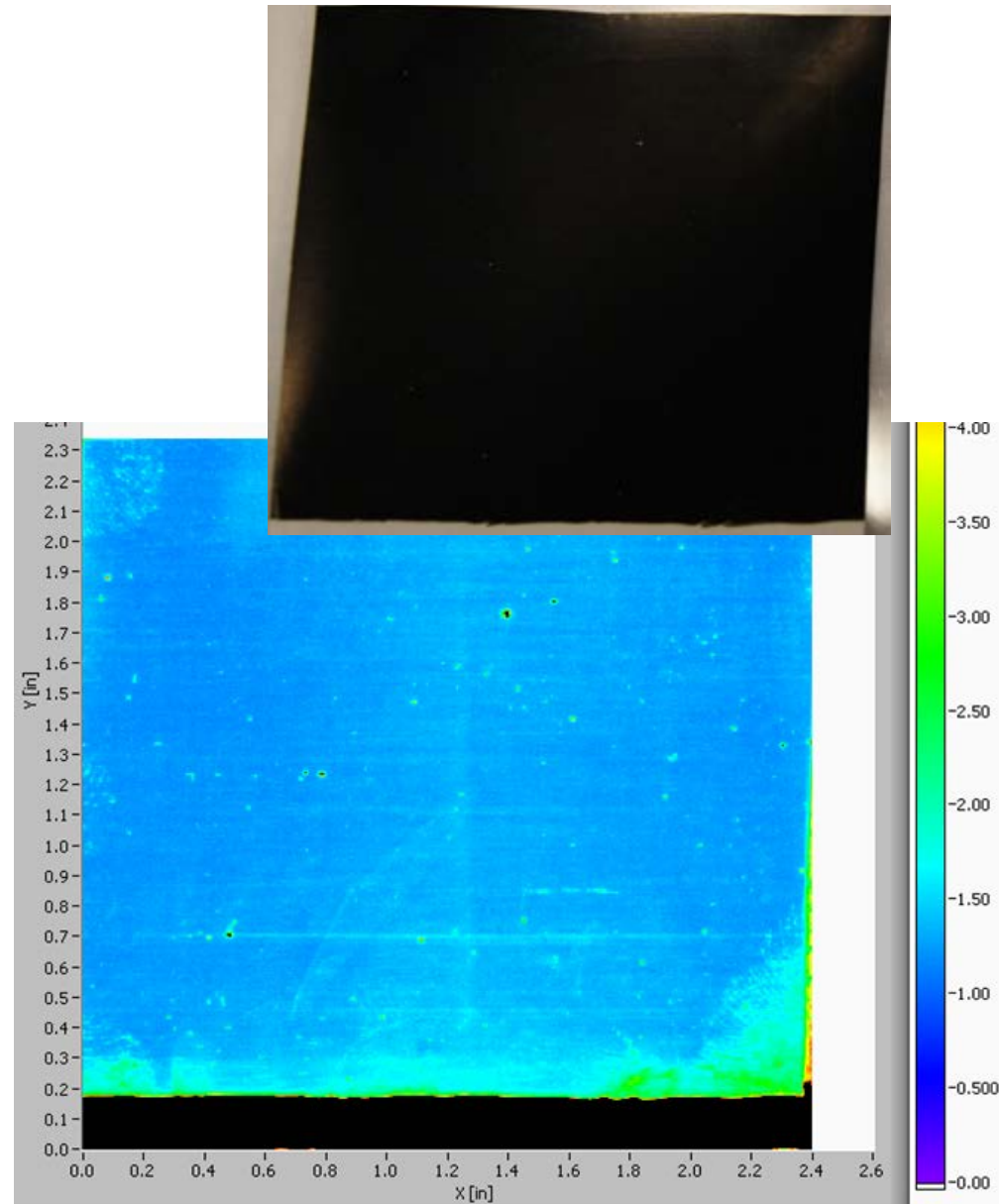

Technical Accomplishments:

Optical diagnostic demonstrated on GDEs

- **Actual defects on GDE sheet**
 - From initial trials of BASF's DOE-funded process improvements
- **Black-on-black defects difficult with commercial vision systems**
- **Detected defects of dimension ~ 1 mm**

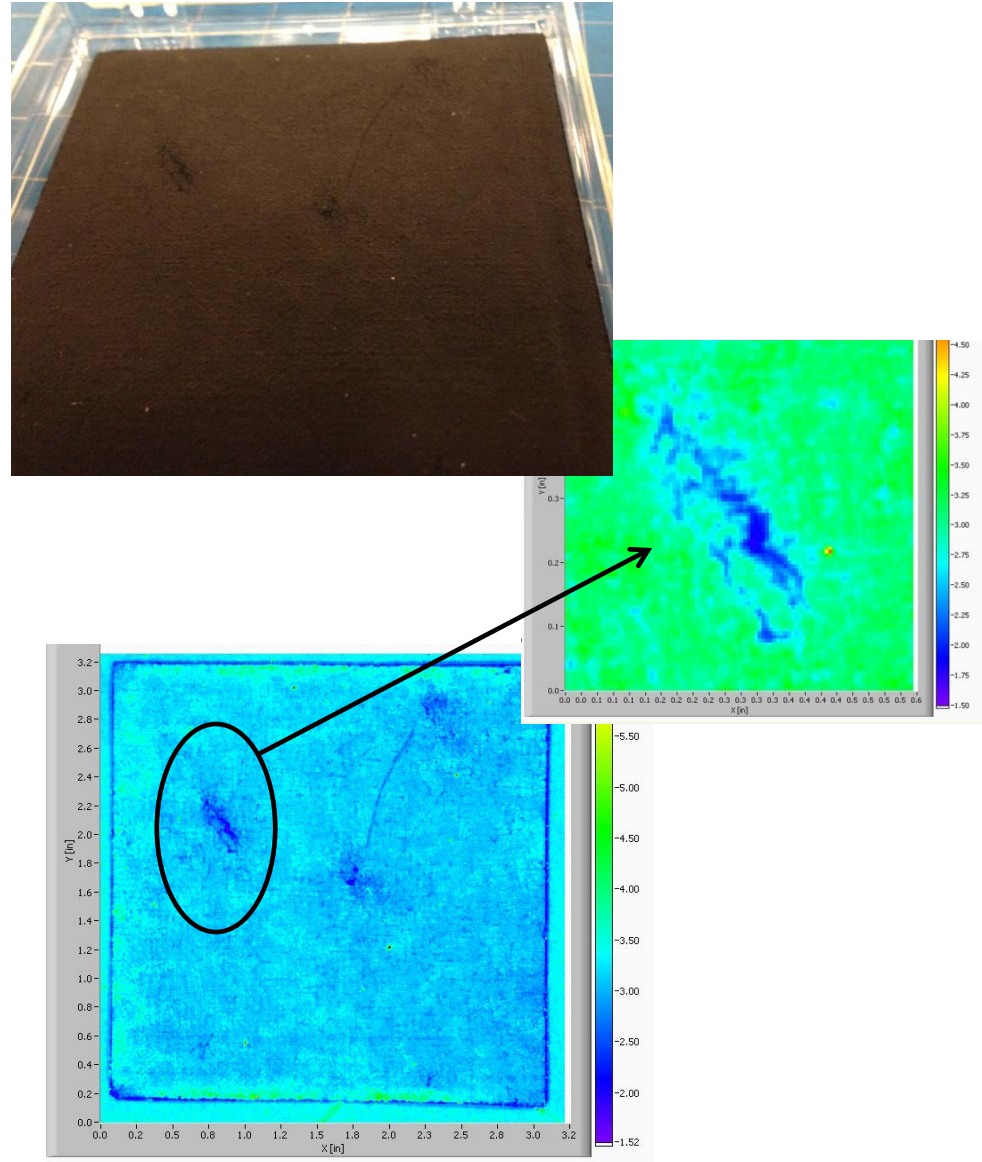

Technical Accomplishments:

Optical diagnostic demonstrated on tube cells

- Studied fired tubes (anode + electrolyte)
- Used standard line camera setup with manual rotation of tube
- Detected defects of ~1 mm dimension

1/4" diameter tube

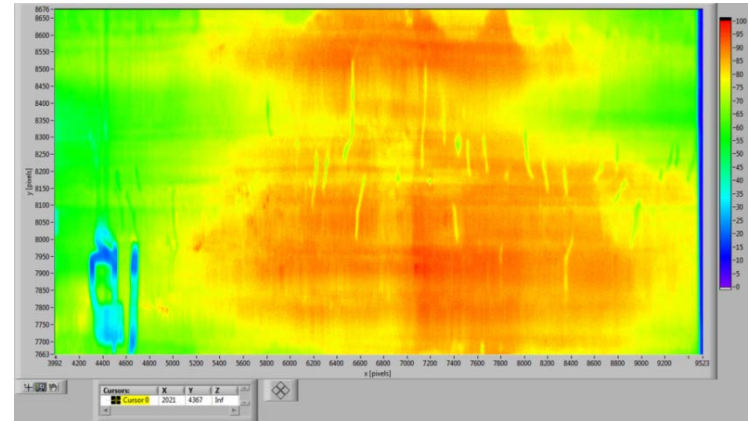
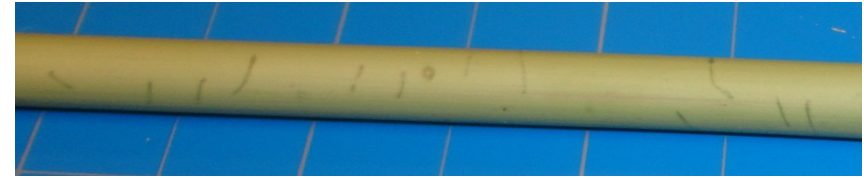

3/4" diameter tube

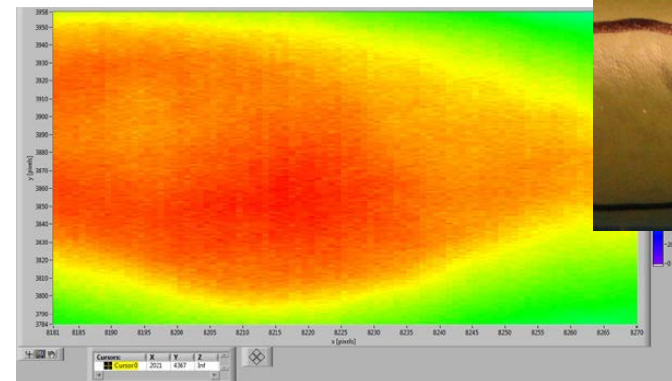

Technical Accomplishments:

Developing improved capabilities for OD

- **Developed dual light source methodology**
 - Improved sensitivity to low reflectance materials (membrane)
 - Improved detection of defects
- **Developed new conveyor-based motion system**
 - Applicable for rigid plate materials
 - Leveraging NREL PV group
- **Investigating use of band-pass filters to separate surface from bulk data**

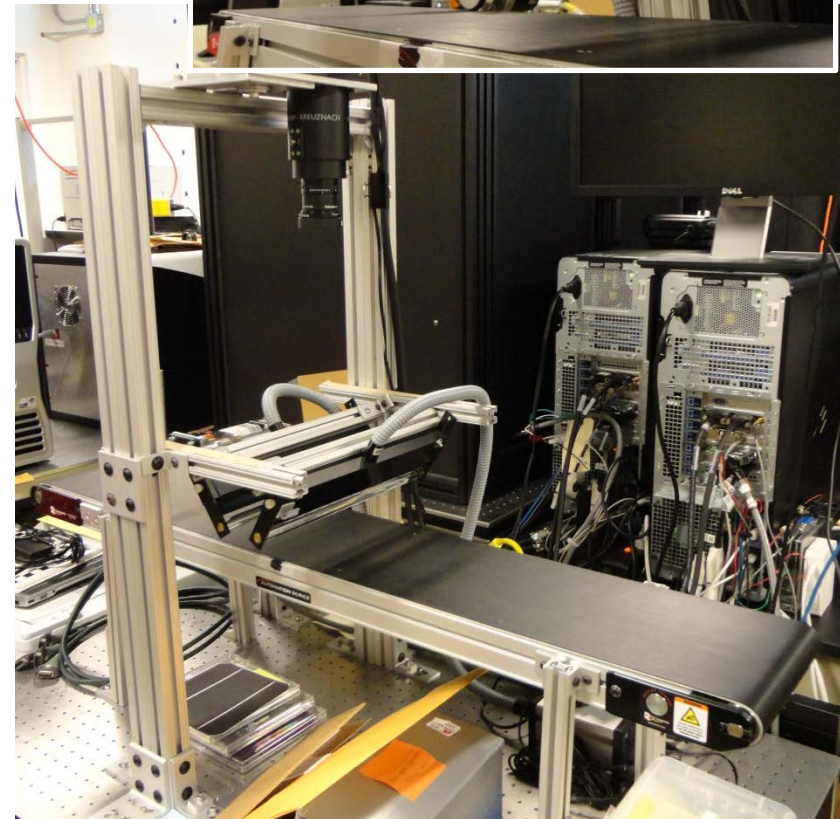
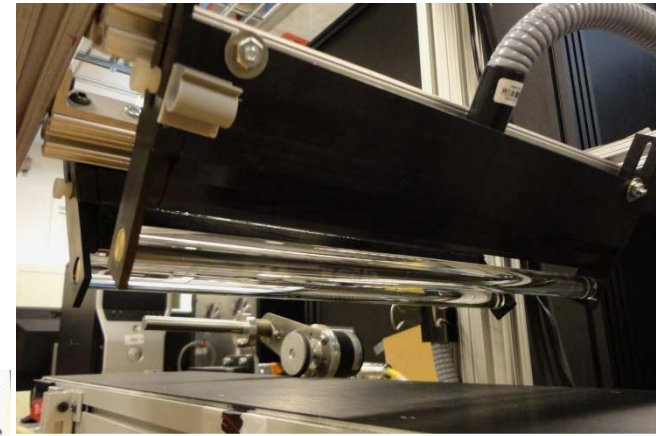

Technical Accomplishments:

Modeling to improve IR/DC diagnostic

- GDL/CCM cracks in line with electrical field hard to detect
- Investigated non-uniform excitation field
- LBNL modeling indicates improvement in detectability
- Modeling used to optimize excitation geometry

Uniform excitation provides very small temperature rise

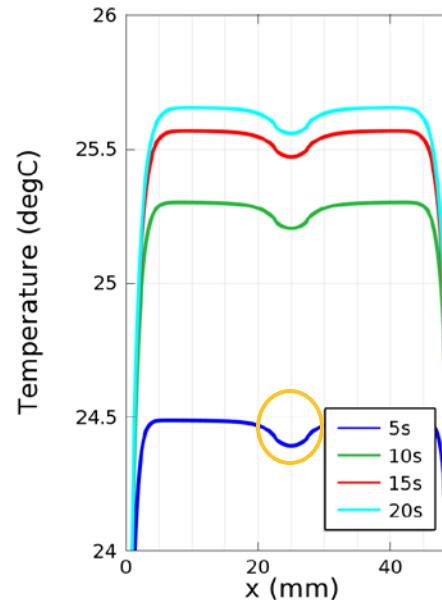
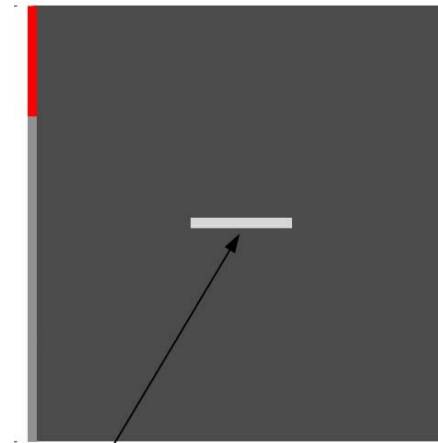

Non-uniform excitation enables detection of $\Delta T > 2^\circ\text{C}$

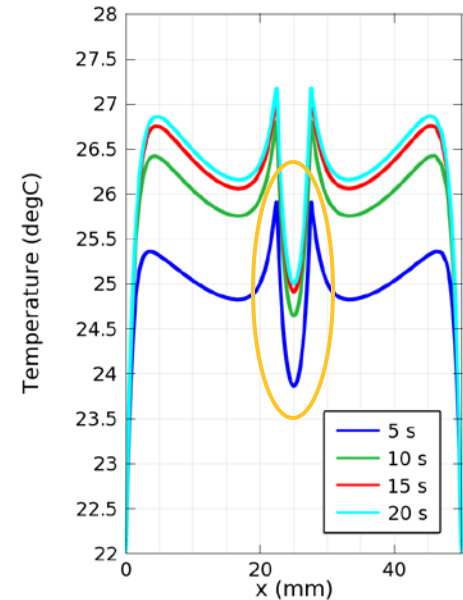
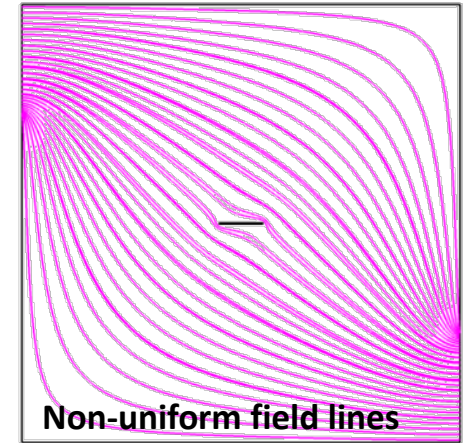

Technical Accomplishments:

Agreement on first industrial deployment of IR/DC

- Validated equipment and operating parameters with experimental material made on coating line
- Designed wider roller system and camera stand for deployment
- Plan to deploy on Ion Power catalyst coating line

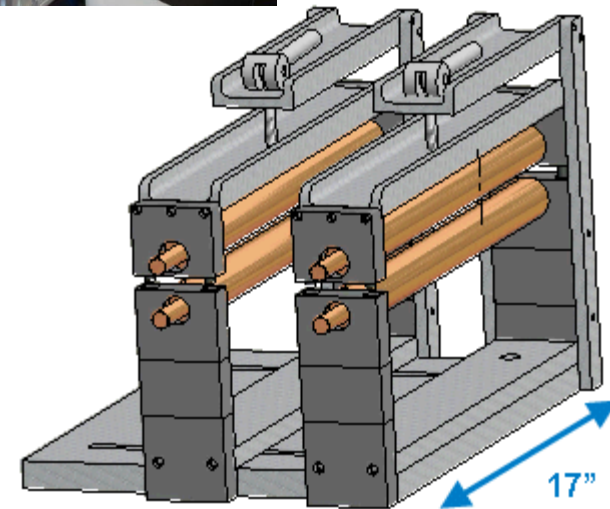
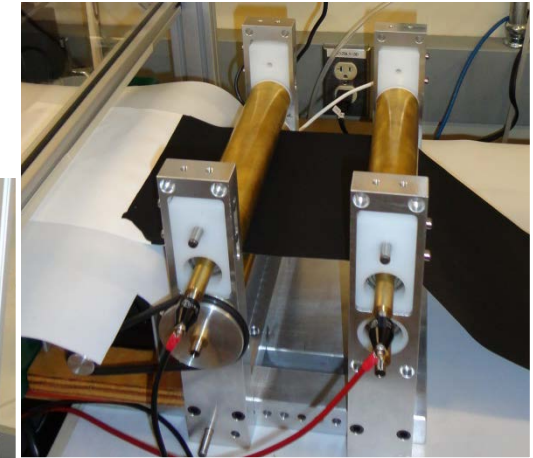
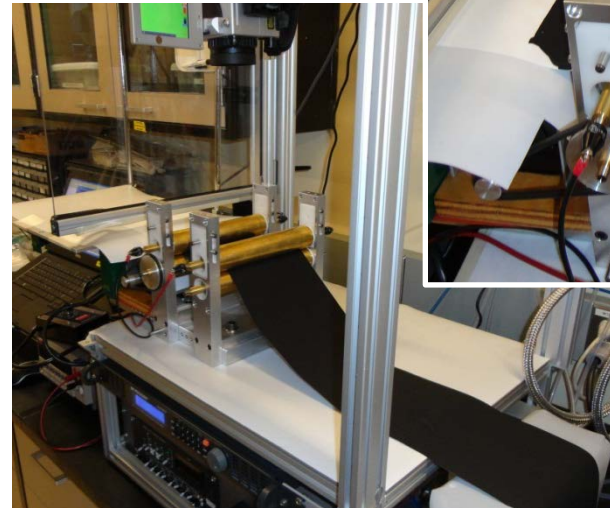

Technical Accomplishments:

Predictive modeling leads to improved IR/RFT detectability

Effect of H₂ concentration

- Initial reactive gas mix (0.4% H₂) chosen based on 10% LFL
- LBNL modeling predicts improvement by increasing H₂ concentration
- Performed experiments with 2% H₂ / 1% O₂ / N₂ balance (<LFL, <5% O₂)
 - Confirmed predicted increase in ΔT
 - Showed that detection time decreases

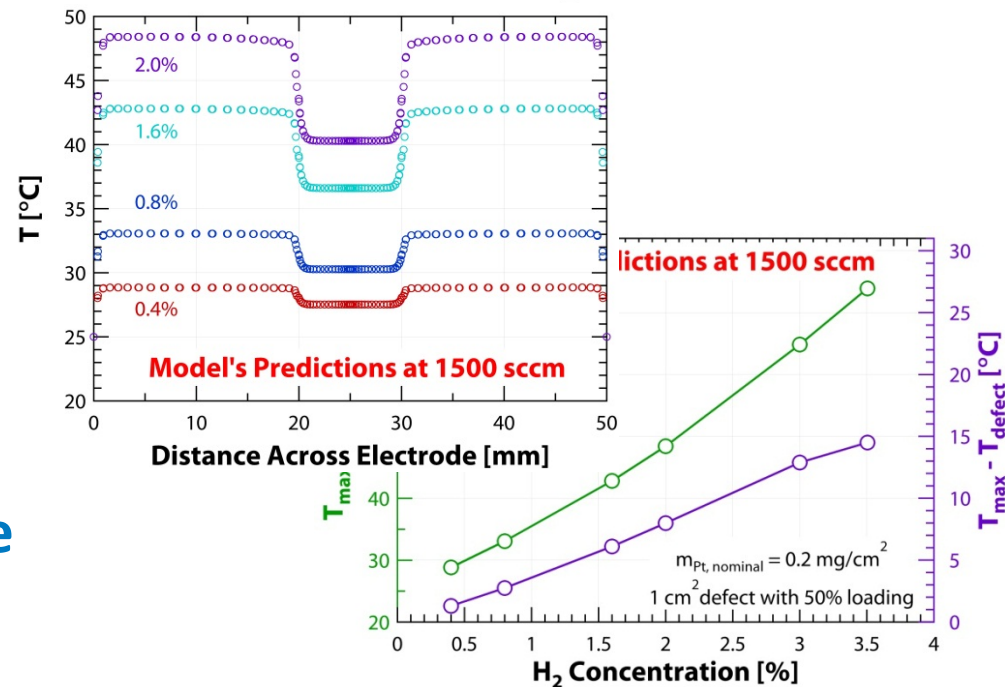
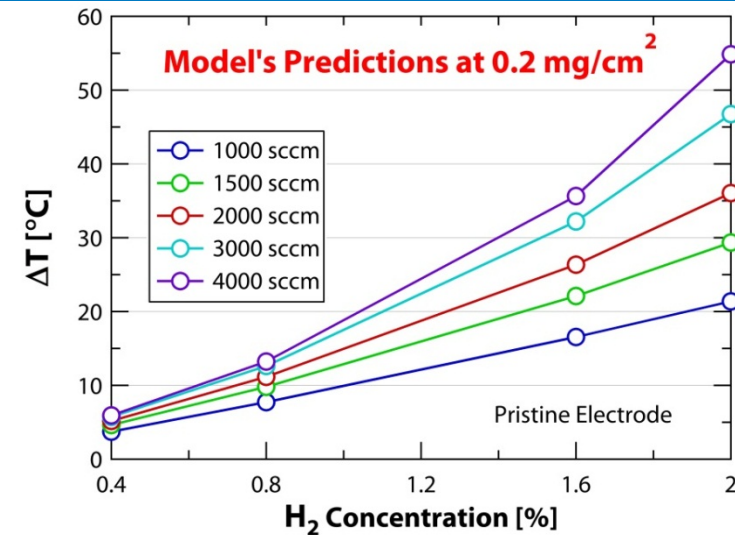

Technical Accomplishments:

Predictive modeling leads to improved IR/RFT detectability

Comparison case: 1500 sccm flowrate, nominal loading 0.2 mg/cm²

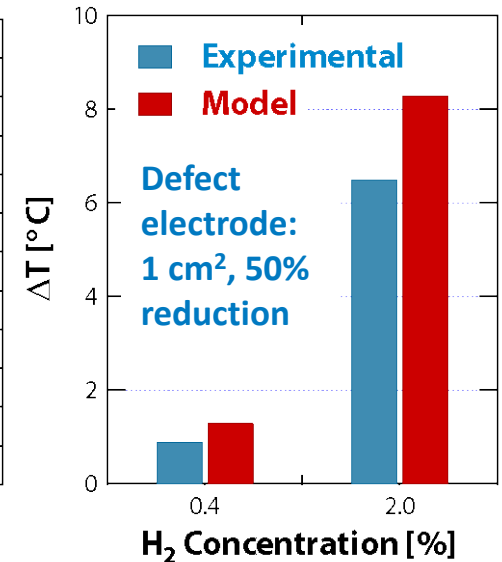
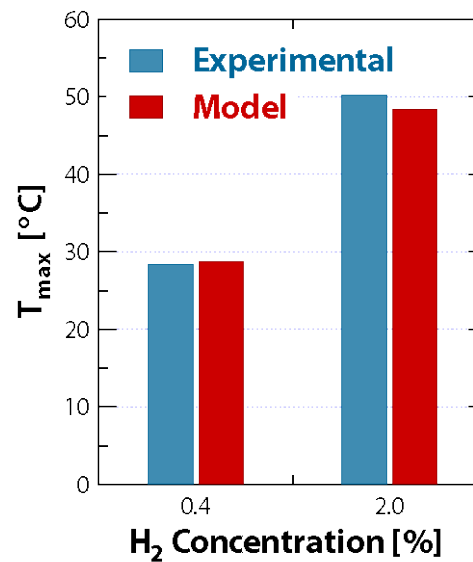
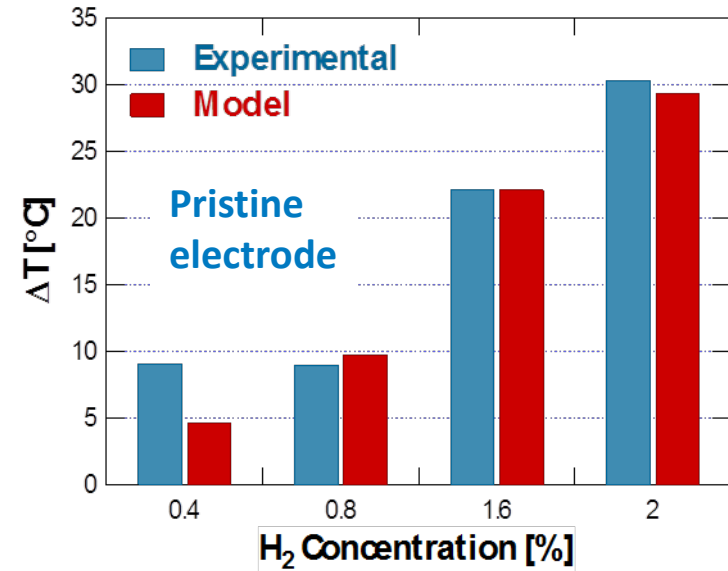

0.0625 cm² with 50% reduction defect:

- Undetected at 0.4% H₂ concentration
- Detected (ΔT=1°C) in less than 1 second at 2% H₂

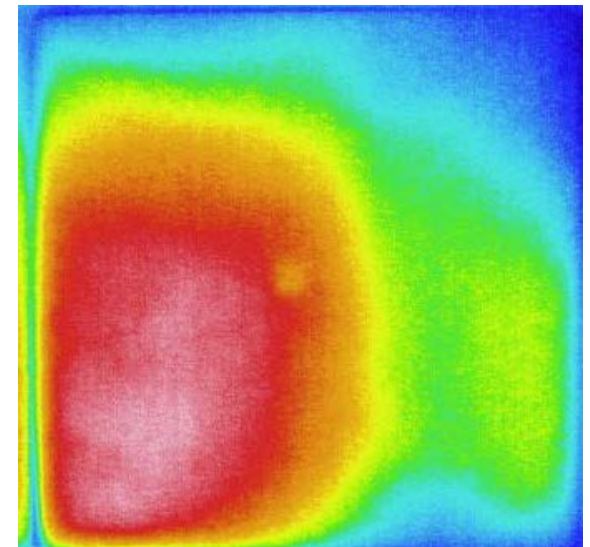
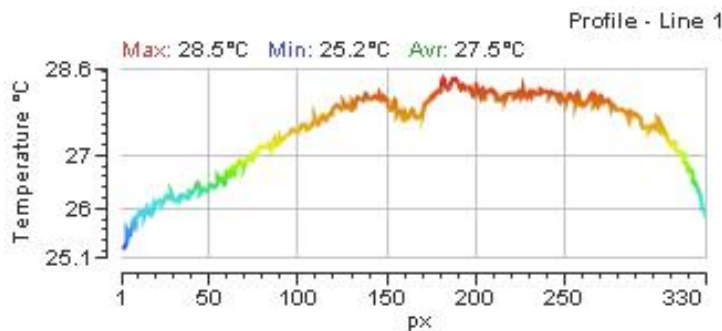

Technical Accomplishments:

Demonstrated IR/RFT in open environment

Prototype air knife

- Home-built knife for determination of feasibility
- 115 holes, 0.5 mm diameter, 2 mm hole spacing
- Enables studies of flowrate, flux, width, knife/substrate separation
- Initial static experiment successful

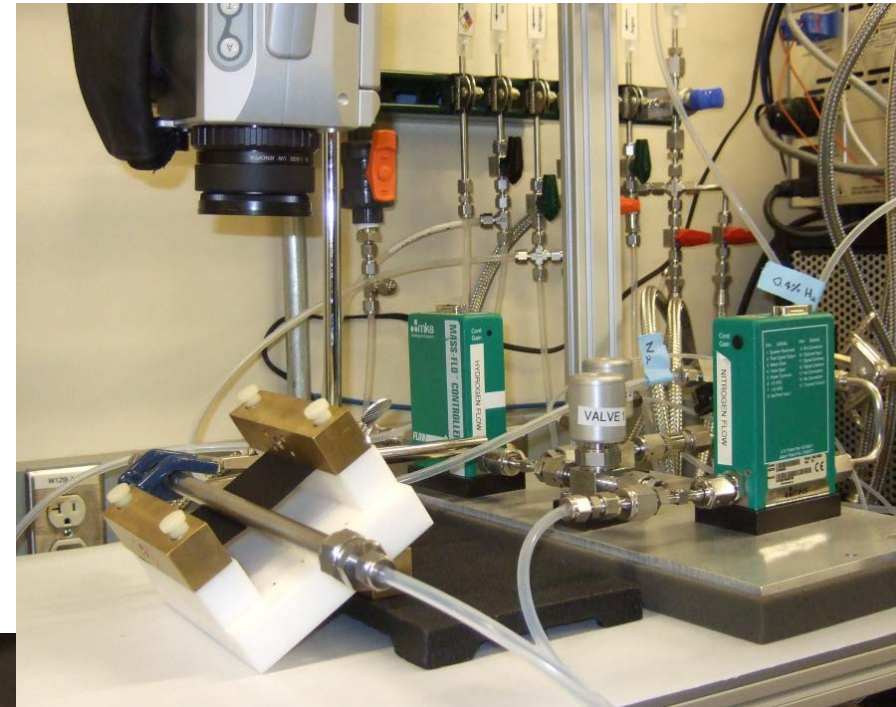

Technical Accomplishments:

Demonstrated IR/RFT in open environment

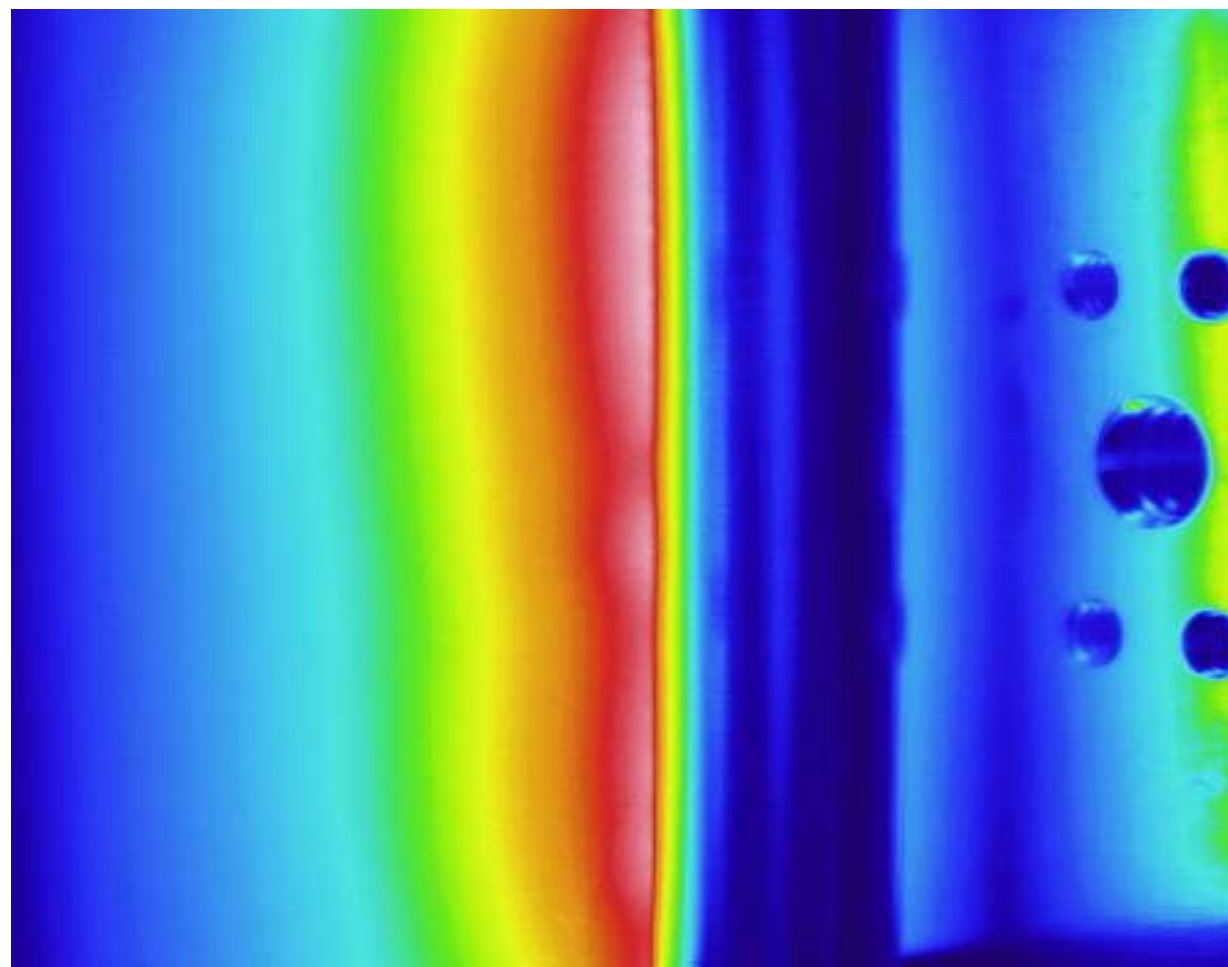

Prototype
Air Knife Temperature
Profile: Static Sample

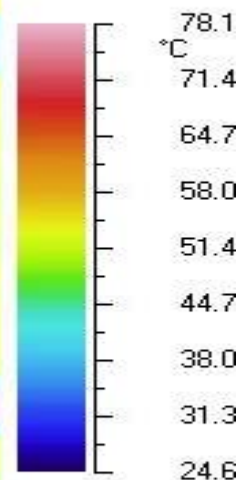

GDE Sheet

Top of knife

Holder

Next step to
demonstrate
with moving
substrate

Technical Accomplishments: New Diagnostic Concept

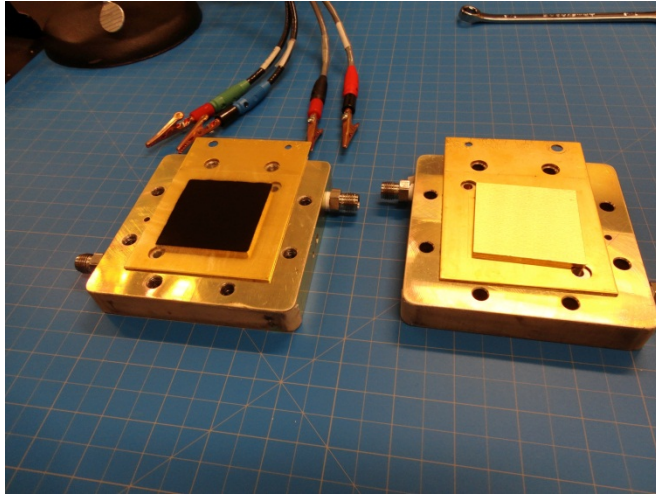

Impedance Measurement of Ionomer:Carbon Ratio

- Does electronic capacitance change with I:C ratio?
- CCMs with 0.4/0.4, 0.4/0.8, 0.8/0.8 I:C ratios investigated (0.2/0.2 mg Pt/cm²)
- AC perturbation 0.1 – 10 kHz, 0.5 V_{pp}
- Dependence of electronic capacitance confirmed
- Ongoing work to determine if sensitivity can be improved to detect smaller variations of I:C ratio

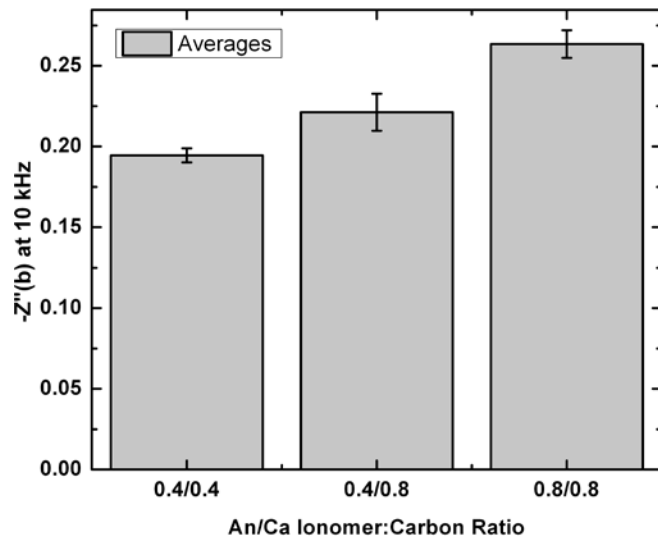

Technical Accomplishments:

Studied electrode bare spot
initial performance effects

What is the threshold
for measurement of
electrode bare spots?

- Initial performance
- Aging

Spatial Performance at 1.0 A/cm²,
Cathode defect, 150/150 kPa,
1050/3500 sccm H₂/air, 100/50% RH

Pristine

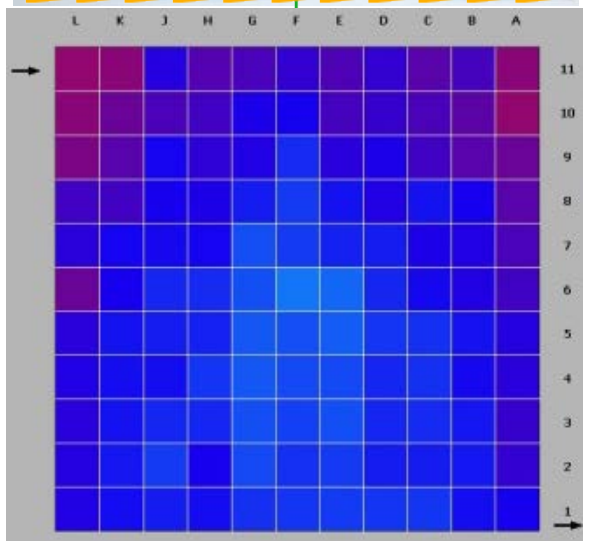
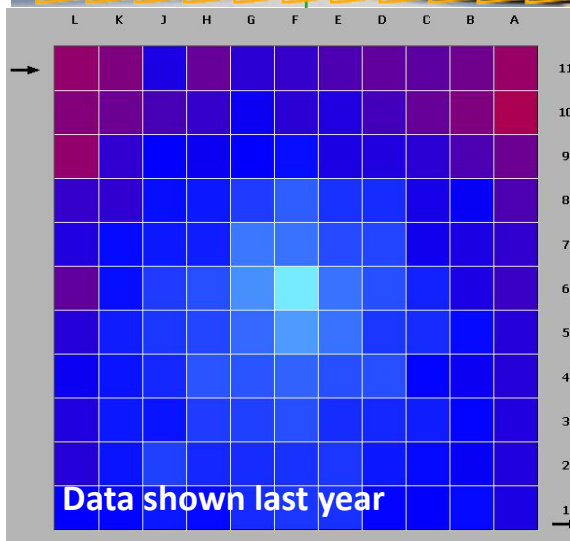
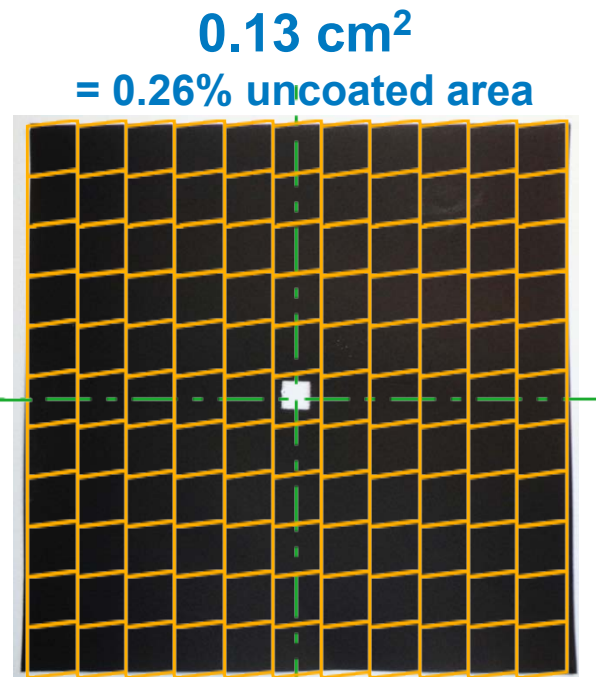
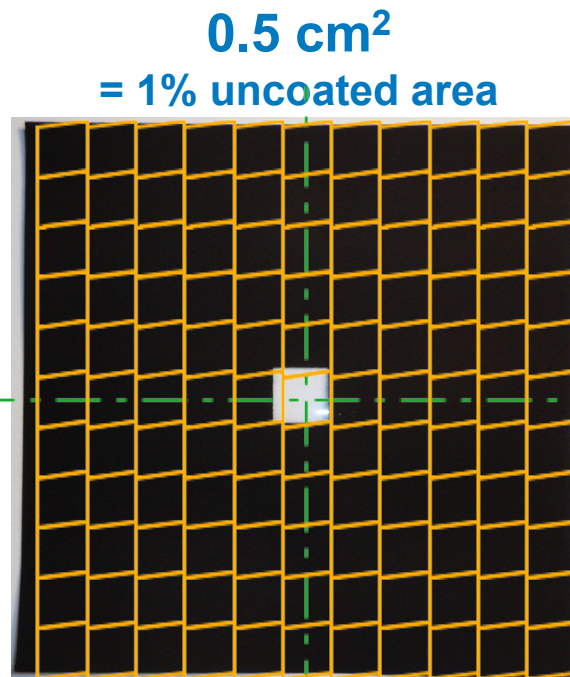
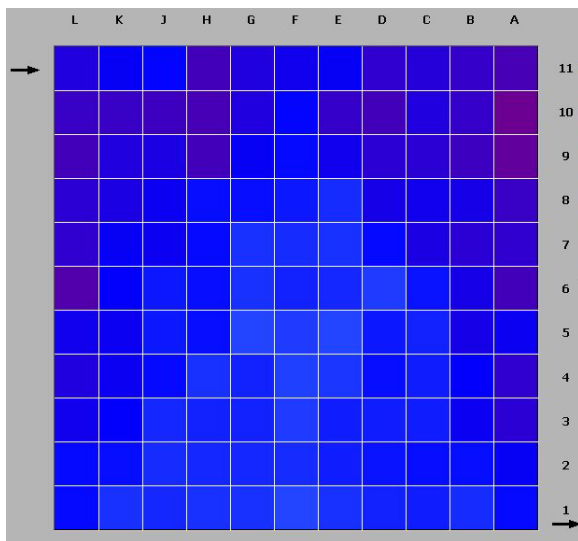

Technical Accomplishments:

Studied electrode bare spot
initial performance effects

- No effect of bare spots on total cell performance
- Reduction of local performance at the defect location (as a function of defect size)
- Based on initial performance at selected conditions, these defects don't need to be detected by QC diagnostics

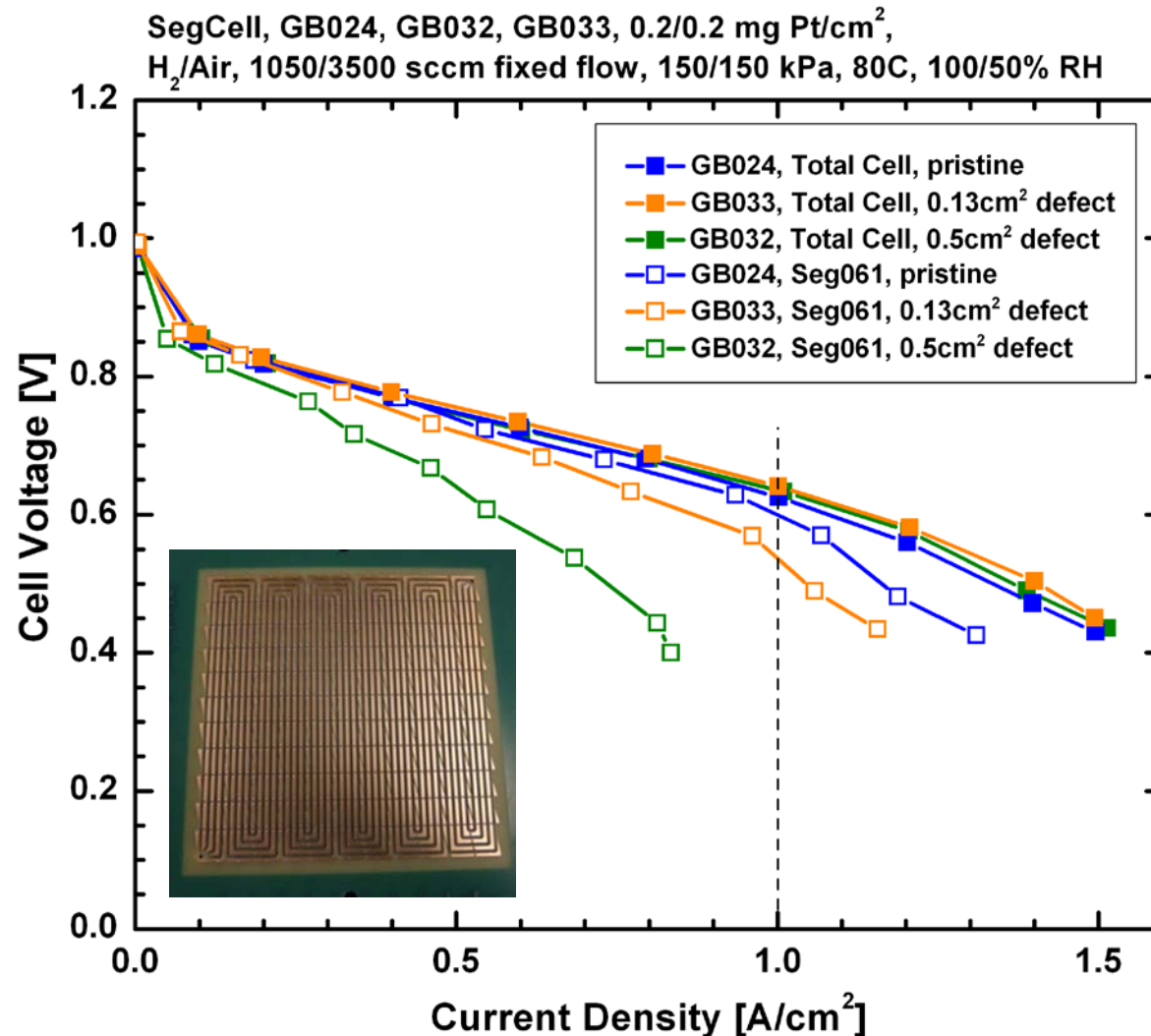

Technical Accomplishments:

Studied electrode bare spot aging effects

- Can we detect and spatially resolve failure due to defects?
- Select (with LANL) and validate accelerated stress test
 - Combined mechanical/chemical AST
- Use OCV with anode overpressure as failure indicator
- Developed new hardware to spatially detect hydrogen crossover

AST Conditions	
AST Duration	24 hrs/step
Cell Temp	80C
H ₂ /Air Gas flows	2000/2000 sccm
Pressures	150/150 kPa
Humidification	90/90 and 20/20C Dew Points switching every 2 min

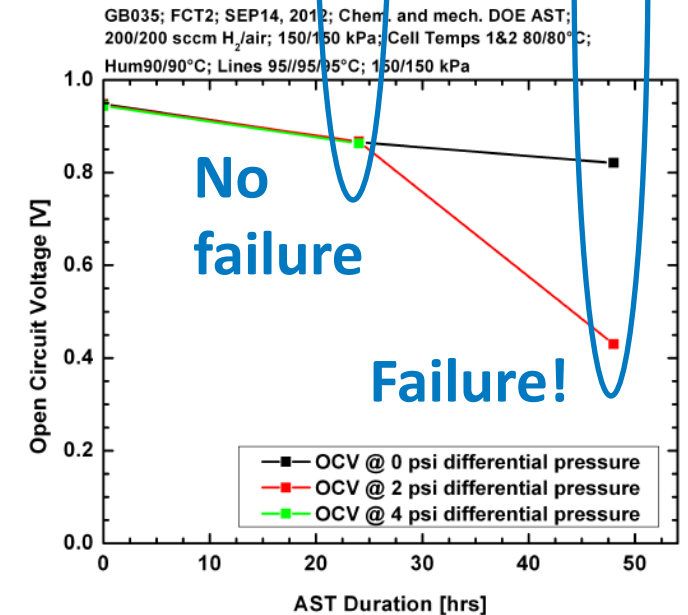
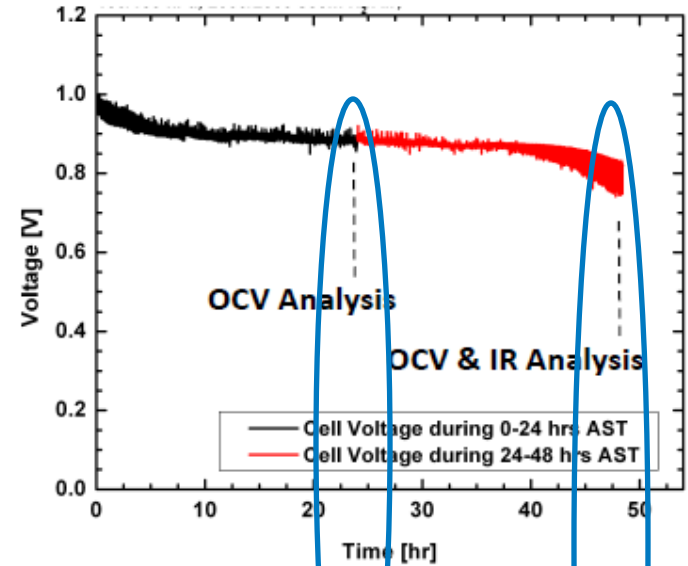
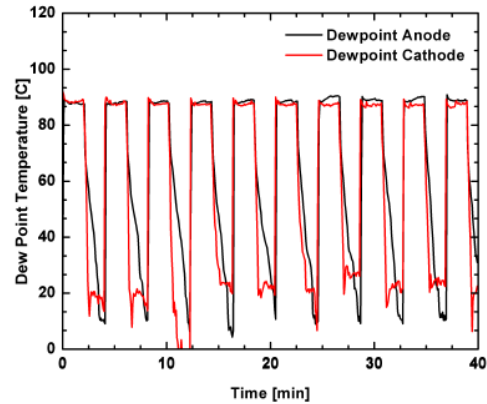

Technical Accomplishments:

Studied electrode bare spot aging effects

- Applied AST to pristine MEAs and MEA with bare spot
- Observed failures at:
 - Edge of active area
 - Location of defect
- Based on aging, this bare spot needs to be detected by QC diagnostics!
- Next steps:
 - 'Tone down' AST to focus on onset of failure point
 - Protect edge of active area to focus on effects of defect
 - Reduce defect size to identify threshold

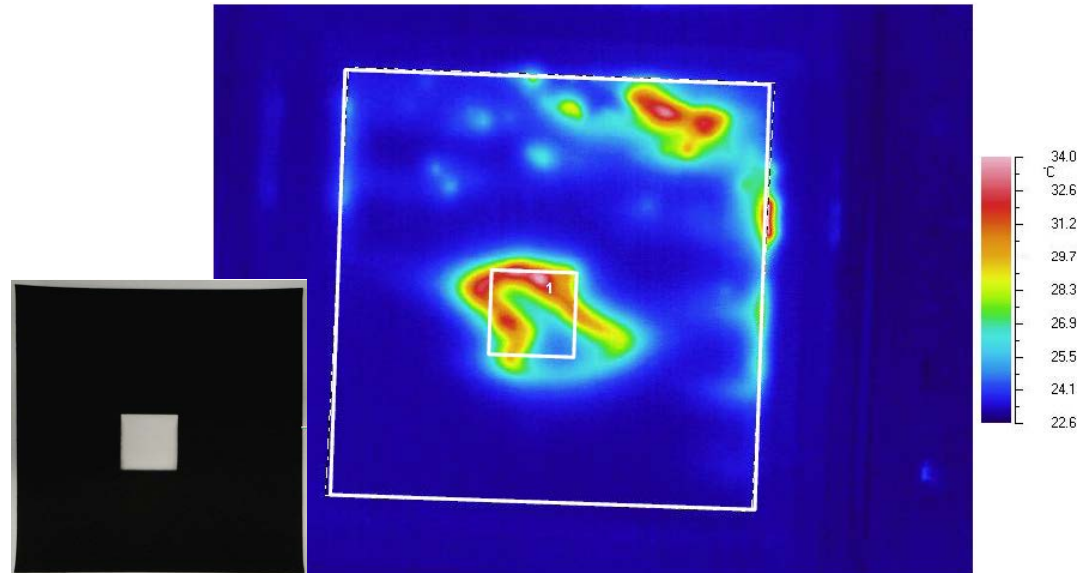
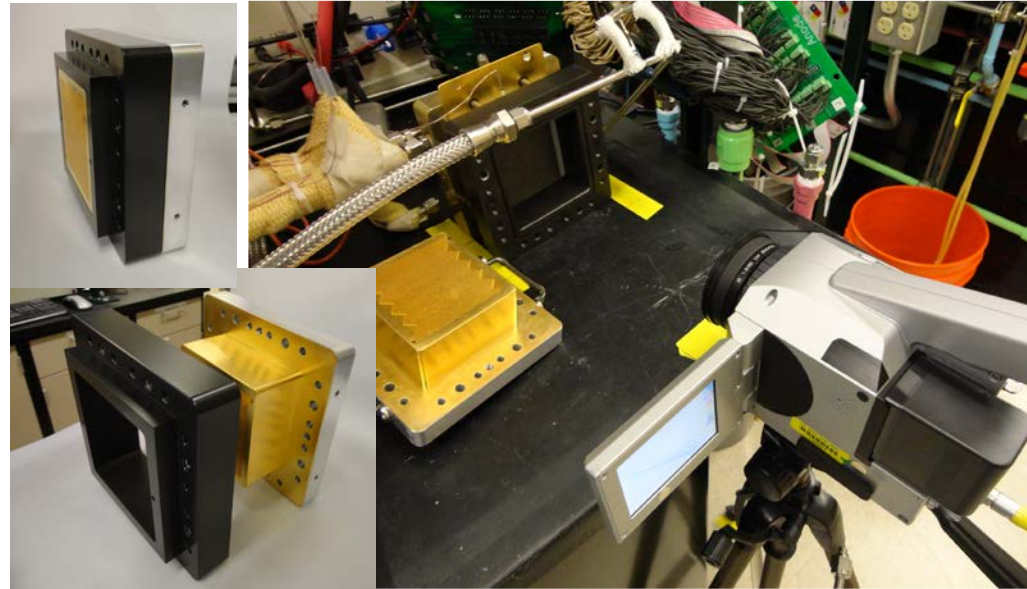

Future Work

- **Work toward deployment of diagnostics on partner manufacturing lines, while continuing to optimize their performance**
- **Complete feasibility study for deployment of IR/RFT diagnostic in-line**
- **Continue to study capacitance and other new diagnostics concepts, per industry inputs**
- **Continue to integrate modeling results to support diagnostic development**
- **Emphasize modeling and in situ testing of effects of defects (MYPP milestones)**
- **Refine protocols and techniques and continue aging and spatial failure studies of electrode and other MEA defects**
- **Complete specific partner studies and continue to support the industry**

Summary

- Highlighted relevance of cross-cutting QC development via cost of poor quality analysis
- Optical Reflectometry:
 - Demonstrated on CCMs (Gore), GDEs (BASF), tubular SOFCs (AMI, Acumentrics)
 - Initiated modifications to improve sensitivity
- IR/DC:
 - Modeled nonuniform excitation to improve detection
 - Initiated effort to deploy on commercial coating line (Ion Power)
 - *Continued development of through-plane method for MEA shorting*
 - *Studied potential noncontact excitation sources*
 - *Studied quality measurements of electrolyzer electrodes (Proton OnSite)*
- IR/RFT:
 - Demonstrated improved detectability via higher H₂ concentration
 - Demonstrated open-environment operation with prototype air knife
- Explored CCM capacitance vs. I:C ratio as a potential new diagnostic
- In situ:
 - Determined local vs. overall performance effects of electrode bare spots
 - Developed new hardware and proved methods for aging and spatial failure detection
 - *Completed detailed performance comparison of ultrasonic vs. thermal pressed MEAs (RPI)*

Acknowledgement

NREL

Michael Ulsh
Guido Bender
Huyen Dinh
Bhushan Sopori
Clay Macomber

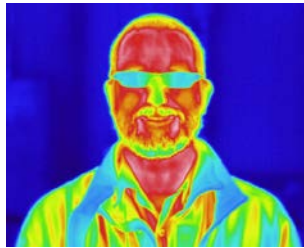
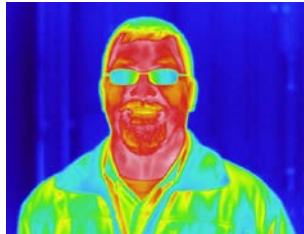

CSM

Prof. Andy Herring
Austin Manak
Prof. Jason Porter
Daniel Bittinat



LBNL

Adam Weber
Prodip Das

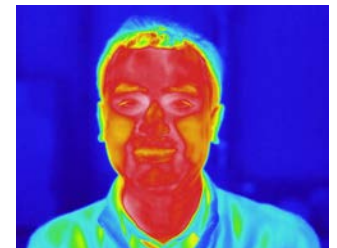

NJIT

Srinivas Devayajanam
Rene Rivero

DOE

Nancy Garland

TECHNICAL BACK-UP SLIDES

PEM Electrolyzer Electrodes

- Experimental Proton OnSite electrodes made by simpler manufacturing process
- Different morphology renders current resistance QC test unstable
 - In situ testing good, but
 - QC test unusable
- Evaluated electrodes for uniformity
 - Part-to-part variability
 - Effects of orientation
 - In-plane conductive discontinuity

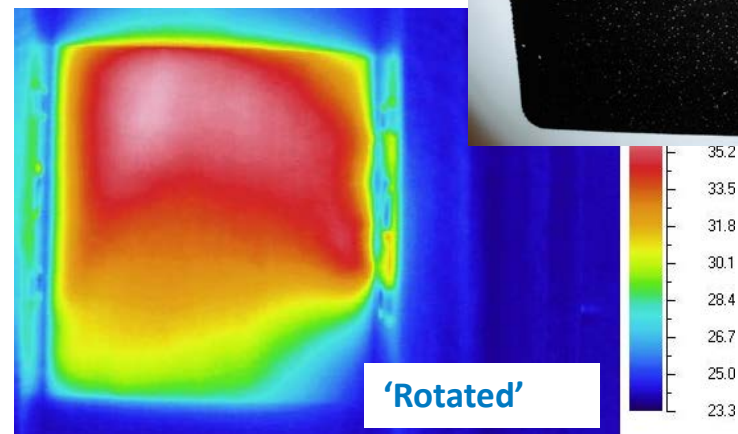
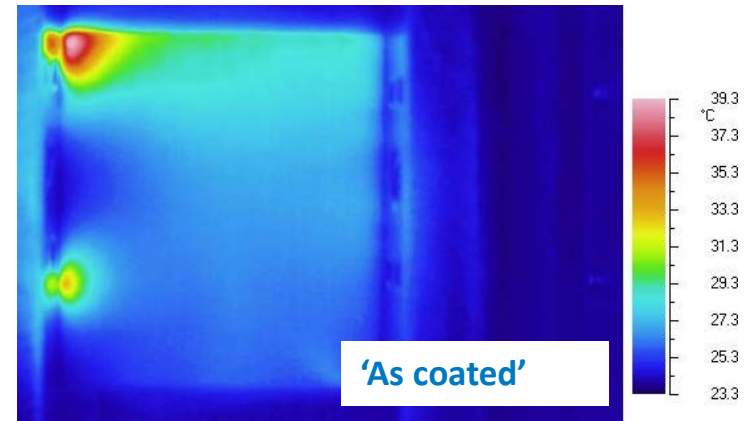

Noncontact Excitation

- Rollers typically used for electrical excitation
 - Contact, but not 'Additional Contact'
- However, minimization of contact may be desired, e.g., for extremely thin layers (NSTF)
- Scoping performed with home-built Eddy Current ring
- GDL sample tested successfully at commercial eddy current supplier
- Also initial experiment and research into microwave as source

Eddy current generator

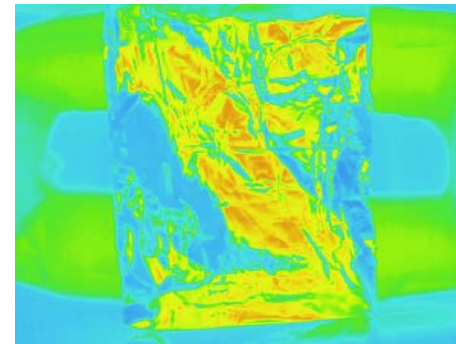

Al foil before excitation

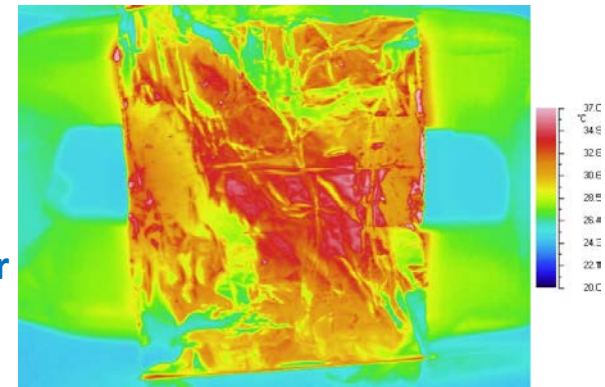

Al foil after excitation

- We completed in situ testing of RPI MEAs, comparing ultrasonic pressing with traditional hot-pressing
 - Sidedness
 - Comparison to Thermal Pressing

U/S: Sidedness of compression

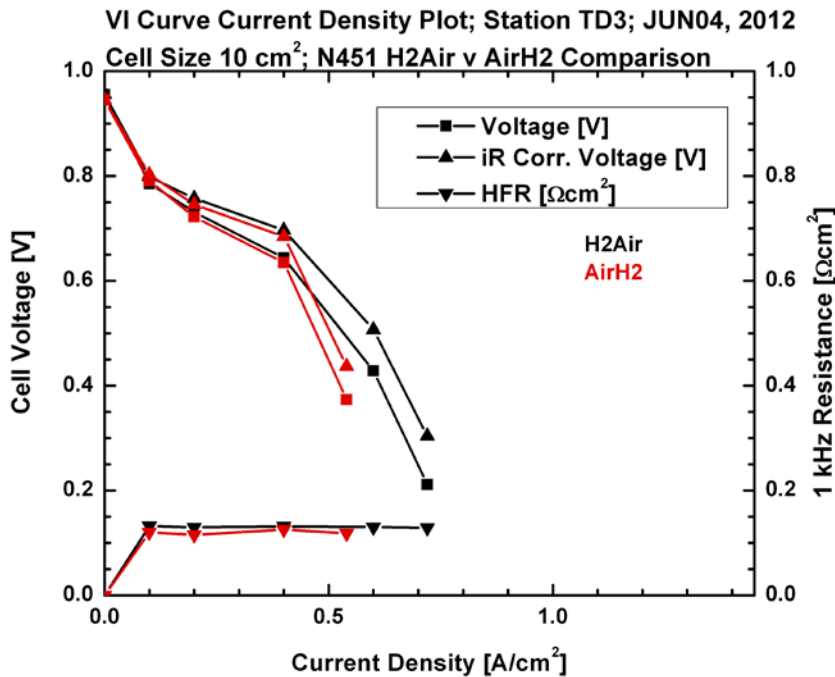

Thermal vs. U/S: H2/Air

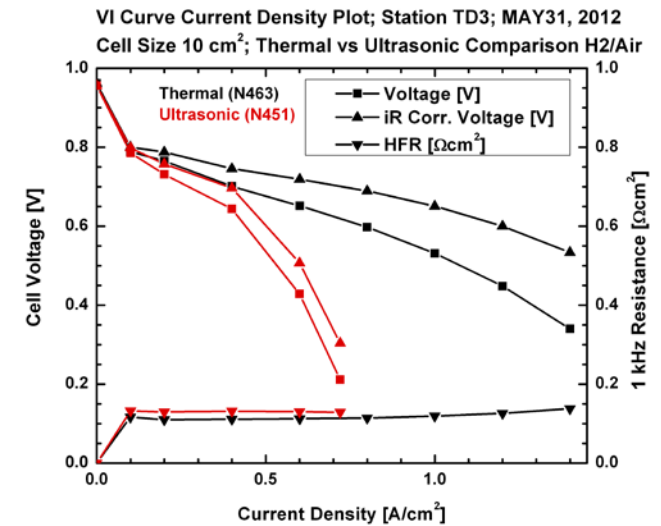

Thermal vs. U/S: H2/O2

