

2013 DOE Hydrogen and Fuel Cells

Program Review

High Speed, Low Cost Fabrication of Gas Diffusion Electrodes for Membrane Electrode Assemblies

Emory S. De Castro
BASF Fuel Cell, Inc.
15 May 2013

MN007

Timeline

- Start: 1 July 2009
 - End: 30 June 2012
 - End*: 30 June 2013
 - 96% complete
- (* no cost extension)

Barriers

- Manufacturing R&D
 - (A) Lack of High Volume Membrane Electrode Assembly (MEA) Processes
 - (F) Low Levels of Quality Control and Inflexible Processes.

Budget

- Total project funding: \$3.06M
 - DOE share: \$1.99M
 - Contractor share: \$1.07M
- Funding received in FY12: \$250K
- Funding for FY13: \$240K

Partners

- Case Western Reserve University
 - Dr. Vladimir Gurau
- X-Ray Optical Systems

Membrane Electrode Assembly (MEA)

5 Layer Assembly

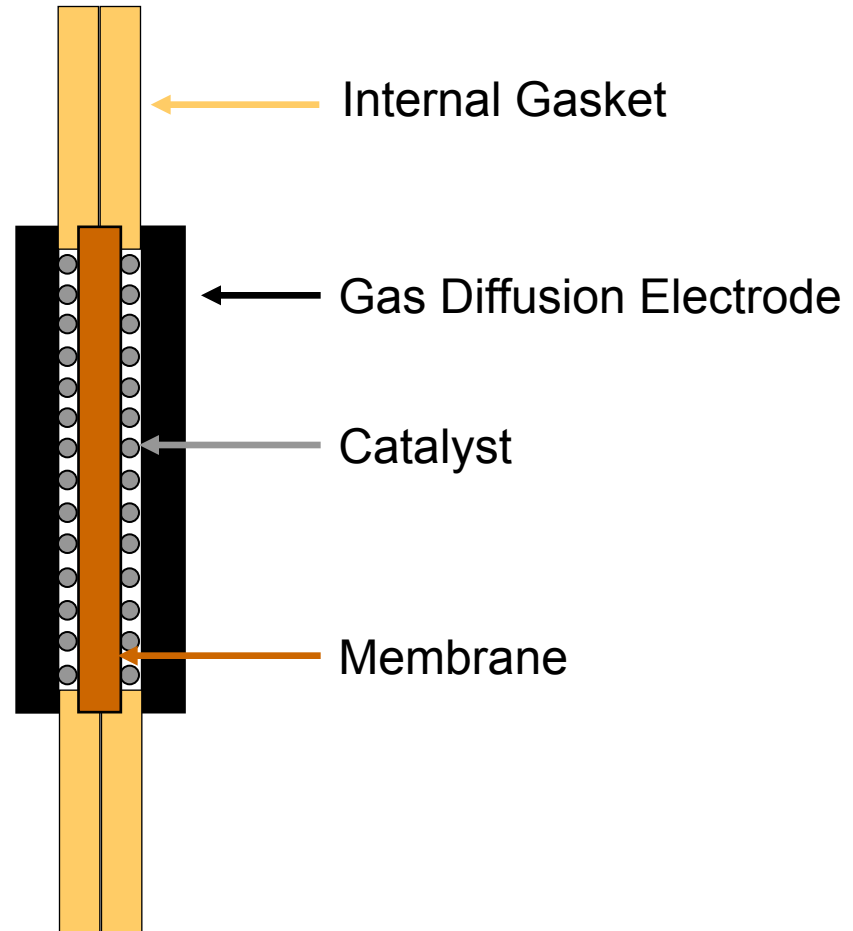
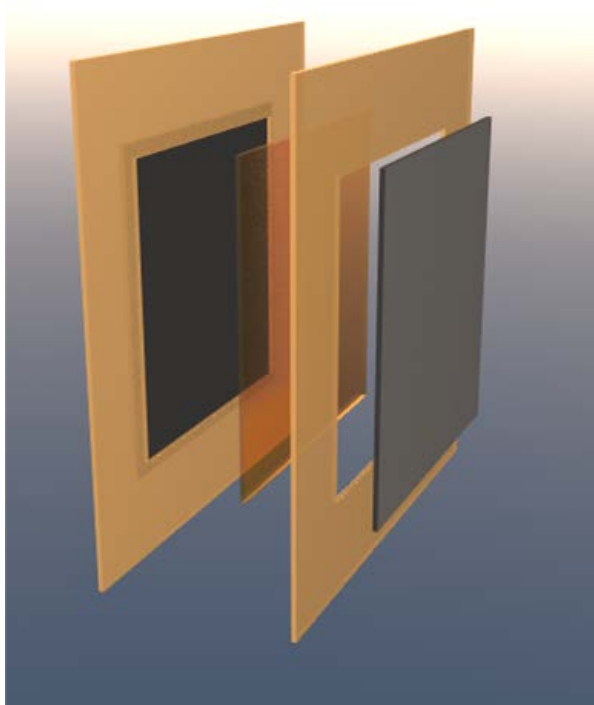

Overall Objective

- Reduce cost in fabricating gas diffusion electrodes (GDEs)
 - Focus on GDEs used for combined heat and power generation (CHP).
- Relate manufacturing variations to actual fuel cell performance in order to establish a cost effective product specification within six-sigma guidelines.
- Develop advanced quality control methods to guide realization of these two objectives.

Objective(s) this reporting period

- Further decrease cost with paper substrates and single-pass applications
- Exploit stable inks to promote platinum thrift

Directly Addresses Barriers

- (A) Lack of High Volume Membrane Electrode Assembly (MEA) Processes
 - High speed or throughput coating
- (F) Low Levels of Quality Control and Inflexible Processes.
 - On-line Pt measurement.

Addresses key DOE targets

Targets: 1–10 kW_e Residential CHP FC Operating on Natural Gas

	2008 Status	2012	2015	2020
Electrical efficiency at rated power	34%	40%	42.5%	45%
CHP energy efficiency	80%	85%	87.5%	90%
Factory cost* per kW	\$750	\$650	\$550	\$450

*Cost includes materials and labor costs to produce 50k/yr stacks

Approach: Milestones and Go/No Go

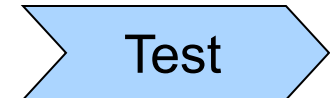

Task	<p>Task 1: On-line QC to guide the process by Y1</p> <p>Task 2: Model impact of defects by Y1</p>	<p>Task 3: full length coating by Y2</p> <p>Task 4: Increase line speed by Y2 (go/no go June 2011)</p> <p>Task 5: Full cloth width roll by Y2/Y3; paper>best cloth total cost</p>	<p>Performance</p> <p>Defects/Uniformity</p> <p>Relate defects to performance</p>
Milestone	<p>T1: On-line Pt measurement, on-roll porosity measurement</p> <p>T2: Verify Model, calculate defect limits</p>	<p>T3: >240 lin m</p> <p>T4: 2X throughput increase (go/no go): 3X final goal</p> <p>T5: full width (>100 cm) & length at 3X throughput: paper 30% lower total cost over cloth</p>	<p>Main Concept</p> <p>Use advanced dispersion and ink formulations to make aqueous solid - binder suspensions compatible</p>
Status	<p>T1: complete, modified for full width cloth. On-roll porosity canceled due to vendor failure</p> <p>T2: Base model established</p>	<p>T3: complete</p> <p>T4: go/no go met. >2X throughput</p> <p>T5: full width/length cloth >3X throughput. Met Paper cost goal.</p>	

Technical Accomplishments and Progress

Task 1: On-line Pt analysis (prior accomplishment)

- **Problem:** commercial XRF units do not have enough power to collect a platinum signal in a short period of time
- **Solution:** Through XOS's polycapillary optics, we are able to use a low power source and obtain amplified signals in a short period of time

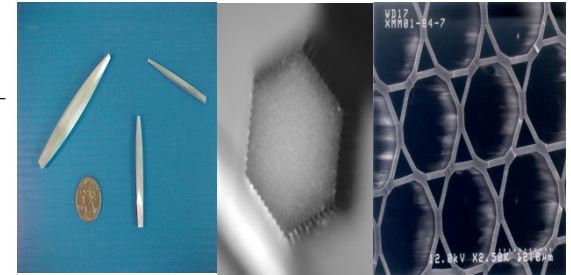
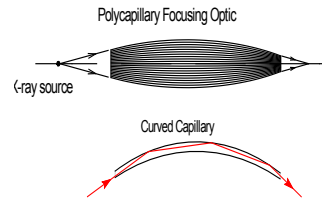

Capillary
Optic

Alignment
Jig

Single
Elements

Design Goals

- Safely used by production staff
- 25 ms accumulation: 10ms achieved
- Rail scan 10 m/s: 20 m/s achieved
- Instrument variation +/-2.5%: <+/-1% achieved
- Minimum level <1 g/m² Pt: initially achieved 1.7 g/m² but believe can exceed minimum with parameter optimization

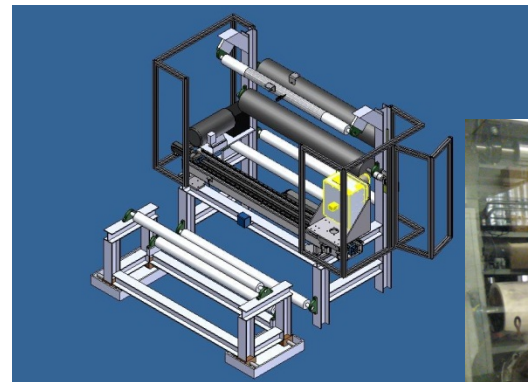

Design Phase



Actual

This is the first time a scanning XRF has been used on GDEs -- exceeded design specifications

Technical Accomplishments and Progress

Tasks 3-4-5: Full Length & Width Roll, 3X speed, Microporous layer (MPL), anode, and cathode (prior accomplishment)



- **Accomplishments:** Quality gains preserved for length>300 l.m, width 1.17 m. Effective throughput boost by reducing number of application passes.

Metric	Benchmark-start	This Program
Agglomerates (avg. over roll)	18/m ²	1.6/m ²
Pt variation (via on-line XRF, roll average)	+/- 2 g Pt/m ²	+/-0.4 g Pt/m ²
Coating throughput, m² GDE/hr	1 (normalized)	3.94
Coating Cost Savings (in labor hrs)		75%
Ink Cost Savings (in labor hrs, avg of mpl, anode, and cathode)		36%
Performance Gain (0.2 A/cm ² -0.5 A/cm ² , 160°C) H₂/air		25mV

Significant improvement in quality and throughput for cloth MPL, anode, and cathode

Technical Accomplishments and Progress

Task 2, subtask 2.2: Create six-sigma specification (new accomplishment)

- **Before DOE Program:** GDE fabrication capability had greater variability than minimum performance needed by customers. High yield loss by selectively picking high-performing material.
- **Program Highlight:** Significant reduction in variability brings manufacturing capability into acceptable zone. Reduced yield losses.

Approach

- Anode: nine full coating lots, 220 fuel cell tests @45 cm²
- Cathode: seven full coating lots, 364 fuel cell tests @45 cm²
- Material passes when $X_{avg} - 2\sigma > \text{min. line}$
- Method accounts for variability as well as performance

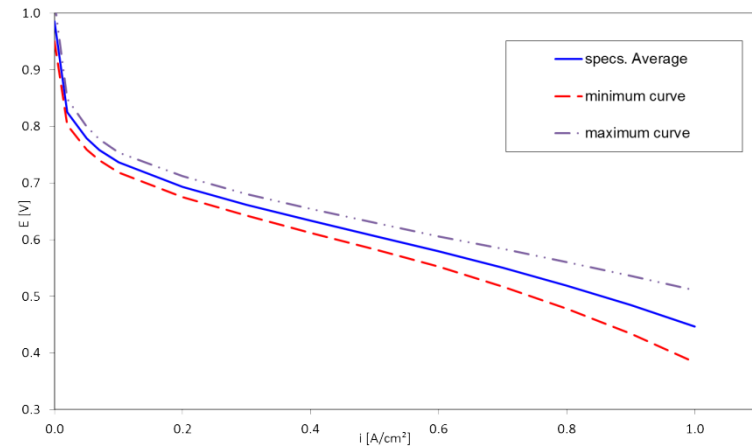

Cathode
average $\pm 3\sigma$
T=160 C
pressure=1
bar_a, stoich:
1.2/2 H₂/air

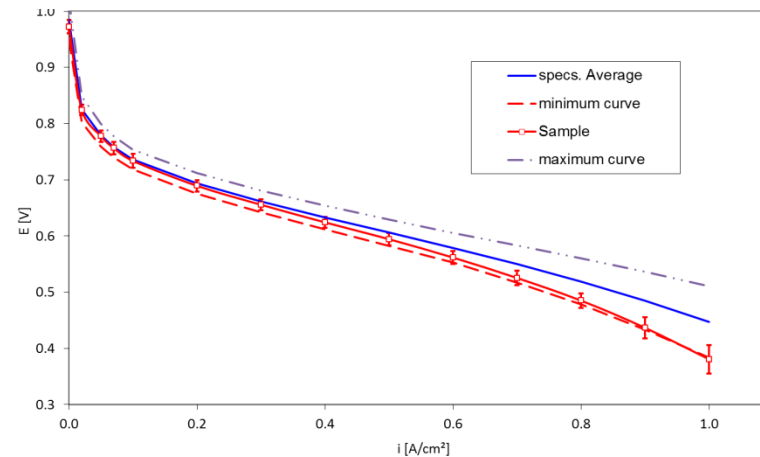

Example of
rejected
material.
Same
conditions
as above

New MEA product released March 2012 based on this work

Technical Accomplishments and Progress

Task 5: Carbon paper substrates (new accomplishment)

- **Status:** 2012 AMR demonstrated production scale multi-step MPL fabrication. 2012/13 focus was on single application steps for MPL and catalyst layer
- **Approach:** Increase solids content (and thus viscosity) of ink without loss of stability. Investigate alternative application process to handle higher viscosity inks
- **Results:** Scaled single-pass MPL to production coating machine. Pilot scale single-pass with catalyst. All at 1/2 width.

Improvement vs. best cloth

Cost (hrs. or material)	% reduction
Coating Time (1/2 width)	28
Coating Time (full width)	64
Base Material Cost*	44
Ink Time	pilot scale

* 3,000 5kW systems

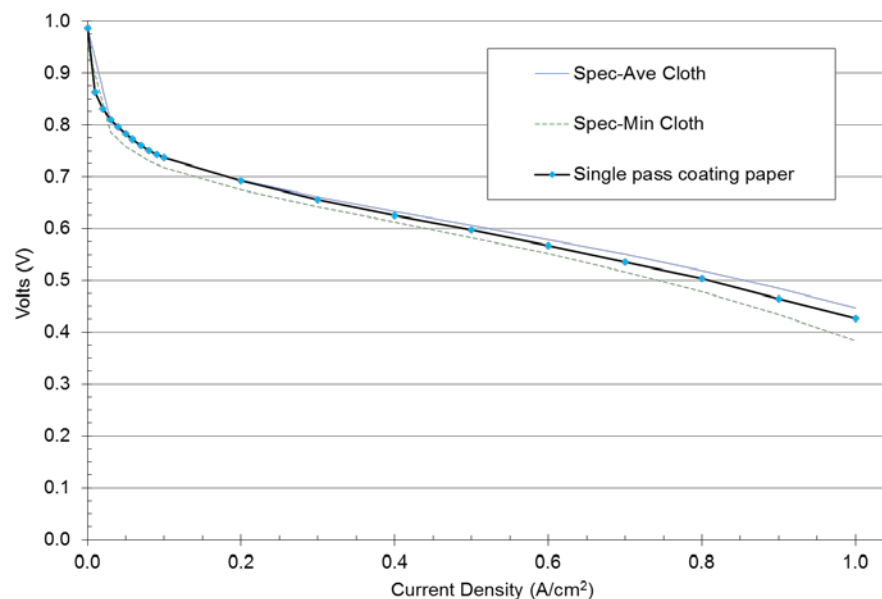

Comparison of single-pass on paper to woven materials from this program - "Spec Avg." & "Spec Min"
T=160 C pressure=1 bar_a, stoich: 1.2/2 H₂/air

Exceeded 30% cost reduction target for paper over best woven configuration

Technical Accomplishments and Progress

New Task from 2012 AMR: Explore PM thrift (new accomplishment)

- **Status:** 2012 AMR review suggested performance gains could be translated into reduction of precious metal
- **Approach:** Use stable inks to create new cloth electrode structures with higher utilization of PM
- **Results:** Demonstrated 30% reduction of PM at anode with materials made on production scale coating machine. Sent MEAs to collaborators for full scale stack verification.

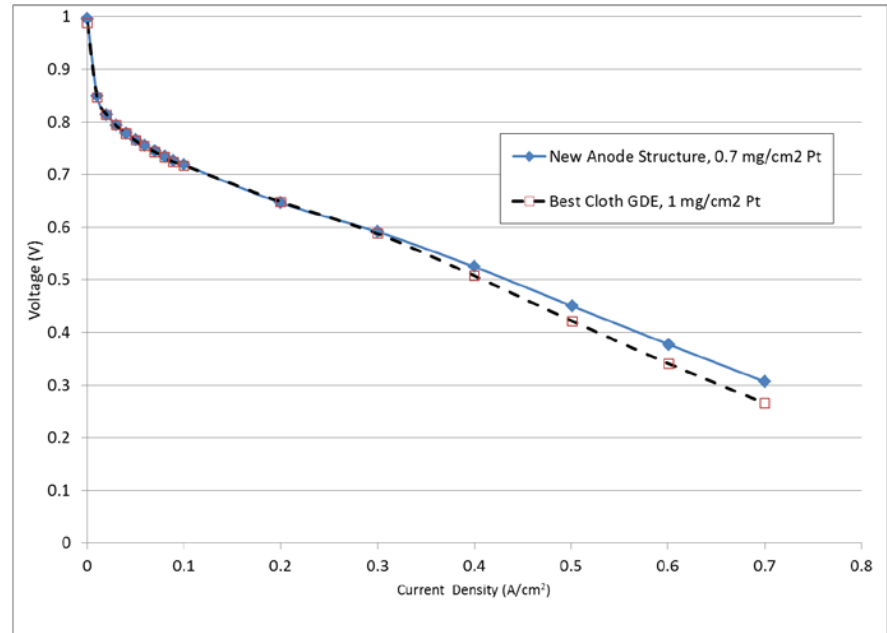

Comparison of new anode structure (lower PM) to best materials from this program

T=160 C, pressure=1 bar_a, stoich: 1.2/2 reformate/air
reformate = 70% H₂, 28% CO₂, 2% CO

30% PM savings not possible with pre-program inks

Task 2 Defects

- **NREL – Michael Ulsh**

- Provided GDEs with defects for advanced defect detection: results shown earlier at MN001

Tasks 5 (paper-based MEAs) and New Task (precious metal thrift)

- **ClearEdge Power –**

- Evaluating materials for use in μ CHP applications at stack scale

Proposed Future Work

Over last quarter of project

- **Task 5: Paper based materials**

- Scale catalyst coating (one application step) to production level

- **After Program Close**

- Translate the gains made here to systems based on corrosion resistant carbons

Summary Slide

Program

- Reduced total GDE labor costs ~75%
- Exceeded 3X throughput program goal to 4X
- Launched new product based on this work, March 2012
 - Transitioned from selectively picking high performers to “six sigma” product

This period

- Demonstrated “one pass” MPL and catalyst coating on carbon paper
- Reduced labor and material costs >30% for paper structures compared to best cloth GDEs
- Demonstrated 30% reduction in platinum loading compared to best cloth-based anodes without losing performance

Acknowledgements

Analytical (Scanning XRF)

- Jeff Morse
- RPI: Glenn Saunders
- PMD: Dennis O'Neil

Coating

- Cesar Cardona
- Stan Lari
- Barzin Keramati

Ink Development/Scale up

- Yu-Min Tsou, Ph.D.
- Zhenyu Liu, Ph.D.
- Renee Verdicchio
- Maria Young
- Will Smith

Fuel Cell Testing - Analytical

- Andrew Van Dyke
- Han Yu, Ph.D.
- Laura Bellamy

Background on high temperature MEAs

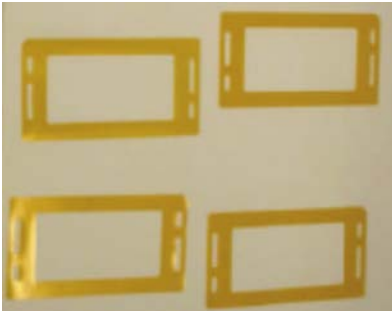

2 x Subgasket

- Polyimide

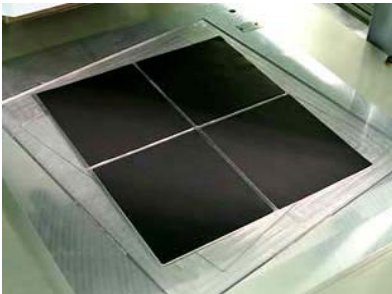

1 x Anode / 1 x Cathode

- Gas diffusion electrode (GDE) with catalyst coating
- Catalyst is coated on top of microporous layer



1 x Membrane

- PBI based >90% phosphoric acid
- Catalyst is not coated on the membrane

Celtec-P MEA Advantages

Technology

- Broad operating temperature window: 120 – 180 °C
- No humidification necessary
- High tolerance to CO and H₂S
- No water management system necessary for exhaust

Materials

- Membrane with Polybenzimidazole (PBI) and Phosphoric Acid (low cost)
- Gas diffusion electrodes (roll to roll processing)

Applications- end use

- Simplified overall FC system

Performance under reformat gas conditions

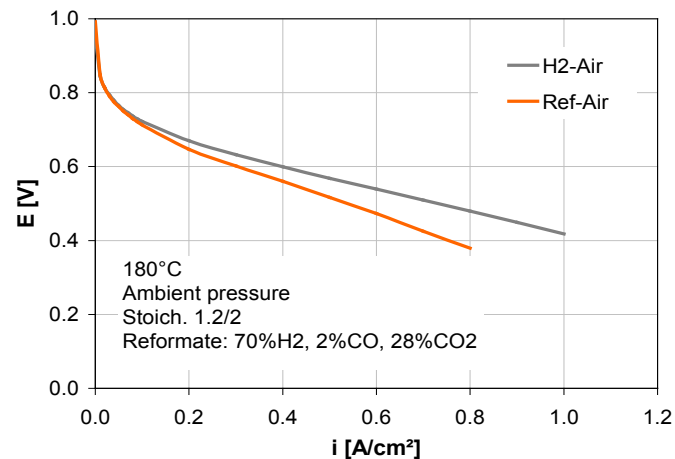

Unique CO-tolerance

