

# **System Level Analysis of Hydrogen Storage Options**

**R.K. Ahluwalia, T.Q. Hua, J-K Peng, and H.S. Roh**

**2015 DOE Hydrogen and Fuel Cells Program Review**

**Arlington, VA**

**June 8-12, 2015**

**Project ID: ST001**

This presentation does not contain any proprietary, confidential, or otherwise restricted information.

# Overview

---

## Timeline

- Project start date: Oct 2009
- Project end date: N/A
- Project continuation and direction determined annually by DOE

## Budget

- FY14 DOE Funding: \$480 K
- FY15 DOE Funding: \$480 K

## Barriers

- H<sub>2</sub> Storage Barriers Addressed:
  - A: System Weight and Volume
  - B: System Cost
  - C: Efficiency
  - E: Charging/Discharging Rates
  - J: Thermal Management
  - K: Life-Cycle Assessments

## Partners/Interactions

- Storage Systems Analysis Working Group (SSAWG)
- PNNL, Tank OEMs
- Delivery Team
- Hydrogen Storage Engineering Center of Excellence (HSECoE): SRNL, LANL
- SA



## Objectives and Relevance

---

Develop and use models to analyze the on-board and off-board performance of physical and material-based automotive hydrogen storage systems

- Conduct independent systems analysis for DOE to gauge the performance of H<sub>2</sub> storage systems
- Provide results to material developers for assessment against system performance targets and goals and help them focus on areas requiring improvements
- Provide inputs for independent analysis of costs of on-board systems.
- Identify interface issues and opportunities, and data needs for technology development
- Perform reverse engineering to define material properties needed to meet the system level targets

Impact of FY2015 work

- Evaluated relationship between HDPE liner properties and liner failure at cryogenic temperatures to support cryo/cold H<sub>2</sub> storage work
- Proposed lower and upper limits to free energy of decomposition ( $\Delta G^0$ ) for energetic off-board regeneration of chemical hydrogen materials
- Established desired range of  $\Delta H$  and decomposition temperature to satisfy on-board storage system targets with chemical hydrogen materials



# Approach

---

- Develop thermodynamic and kinetic models of processes in physical, complex metal hydride, sorbent, and chemical H<sub>2</sub> storage systems
  - Address all aspects of on-board and off-board storage targets, including capacity, charge/discharge rates, emissions, and efficiencies
  - Perform finite-element analysis of compressed hydrogen storage tanks
  - Assess improvements needed in materials properties and system configurations to achieve storage targets
- Select model fidelity to resolve system-level issues
  - On-board system, off-board spent fuel regeneration, reverse engineering
  - Conduct trade-off analyses, and provide fundamental understanding of system/material behavior
  - Calibrate, validate, and evaluate models
- Work closely with DOE technology developers, HSECoE and others in obtaining data, and provide feedback
- Participate in SSAWG meetings and communicate approach and results to foster consistency among DOE-sponsored analysis activities



# Summary: FY2015 Tasks and Accomplishments

---

## 1. Physical storage

- ABAQUS simulations of HDPE liners at 150-200 K (in progress)
- On-board cold gas H<sub>2</sub> storage system and off-board WTT efficiency
- Validate ABAQUS models for tanks with advanced materials and winding techniques (pending)

## 2. H<sub>2</sub> storage in metal hydrides

- Published paper in IJHE on reverse engineering to determine material properties needed to meet system targets with low-temperature metal hydrides

## 3. H<sub>2</sub> storage in sorbents

- Publishing paper in IJHE on reverse engineering to determine material properties needed to meet system targets including well-to-tank (WTT) efficiency
- Validate and update sorbent model utilizing HSECoE data (pending)

## 4. Chemical hydrogen storage

- Reverse engineering to determine material properties needed to meet system targets including well-to-tank efficiency
- Validate and update reactor and BOP models utilizing HSECoE data (ongoing)



# Technical Accomplishments: Stress and Strain Behavior in HDPE

Collaborating with PNNL to determine the relationship between HDPE liner properties and liner failure at cryogenic temperatures in support of work on cryo/cold hydrogen storage in Type 4 tanks

Liner behavior at room temperature

- Small compressive stresses at 2 MPa, increasing to -41 MPa (axial), -38 MPa (hoop) at 70 MPa
- No failure anticipated

At -190°C, liner is in tension

- For HDPE with  $E = 2 \text{ GPa}$ , tensile stress in the liner is below the tensile strength
- For HDPE with  $E = 6 \text{ GPa}$ , tensile stress in the dome is well above the 150-MPa tensile strength, tank failure is predicted

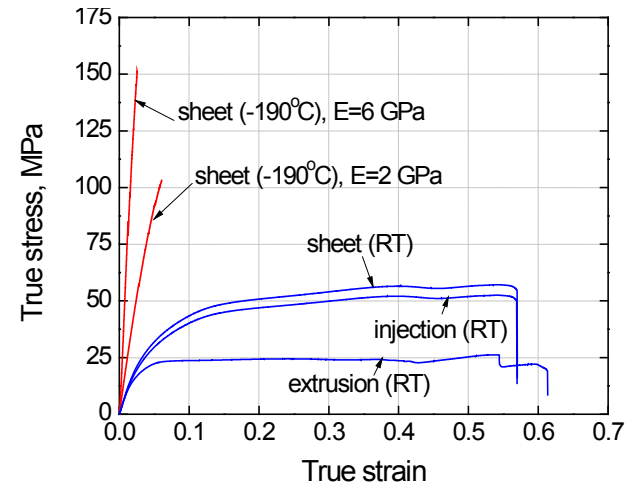

PNNL Data (David Gotthold)

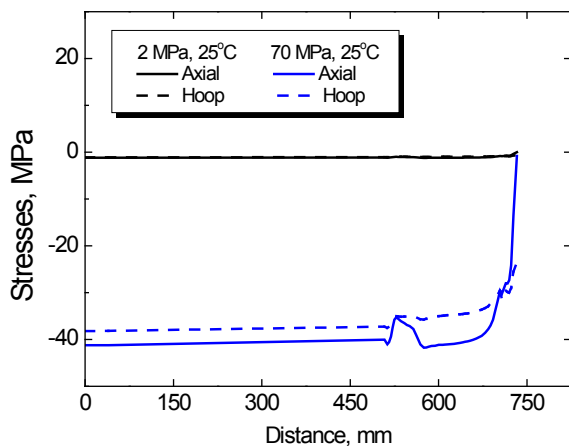

T = 25 °C

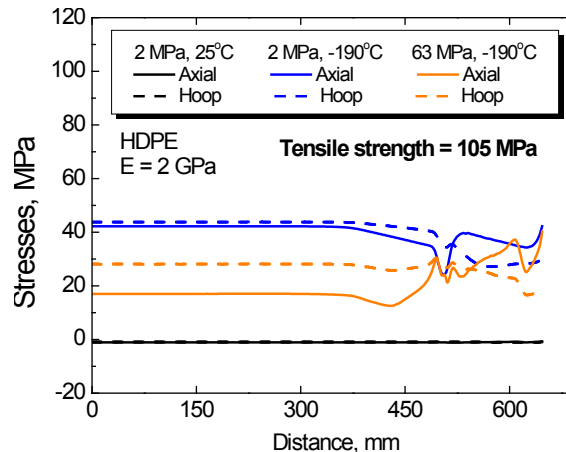

T = -190°C, E = 2 GPa

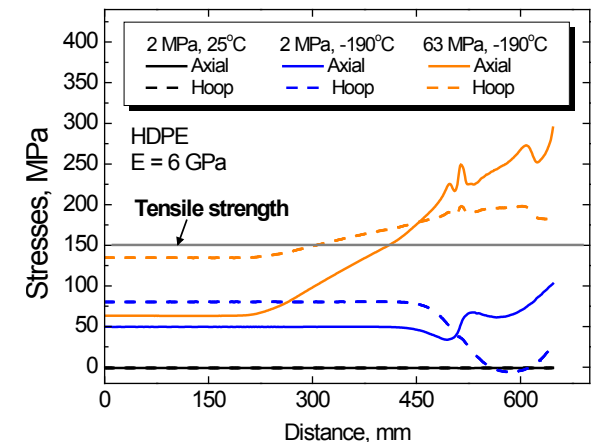

T = -190°C, E = 6 GPa

# Liner Separation at Low Temperature

- Minimum internal pressure needed to avoid liner separation at near LN<sub>2</sub> temperatures (-190°C)
  - Gaps exist between the liner and CF in the cylinder and dome sections of the tank as a result of differential CTEs if the internal pressure is <2 MPa
  - Gap exists in the dome if the tank internal pressure is <3.2 MPa

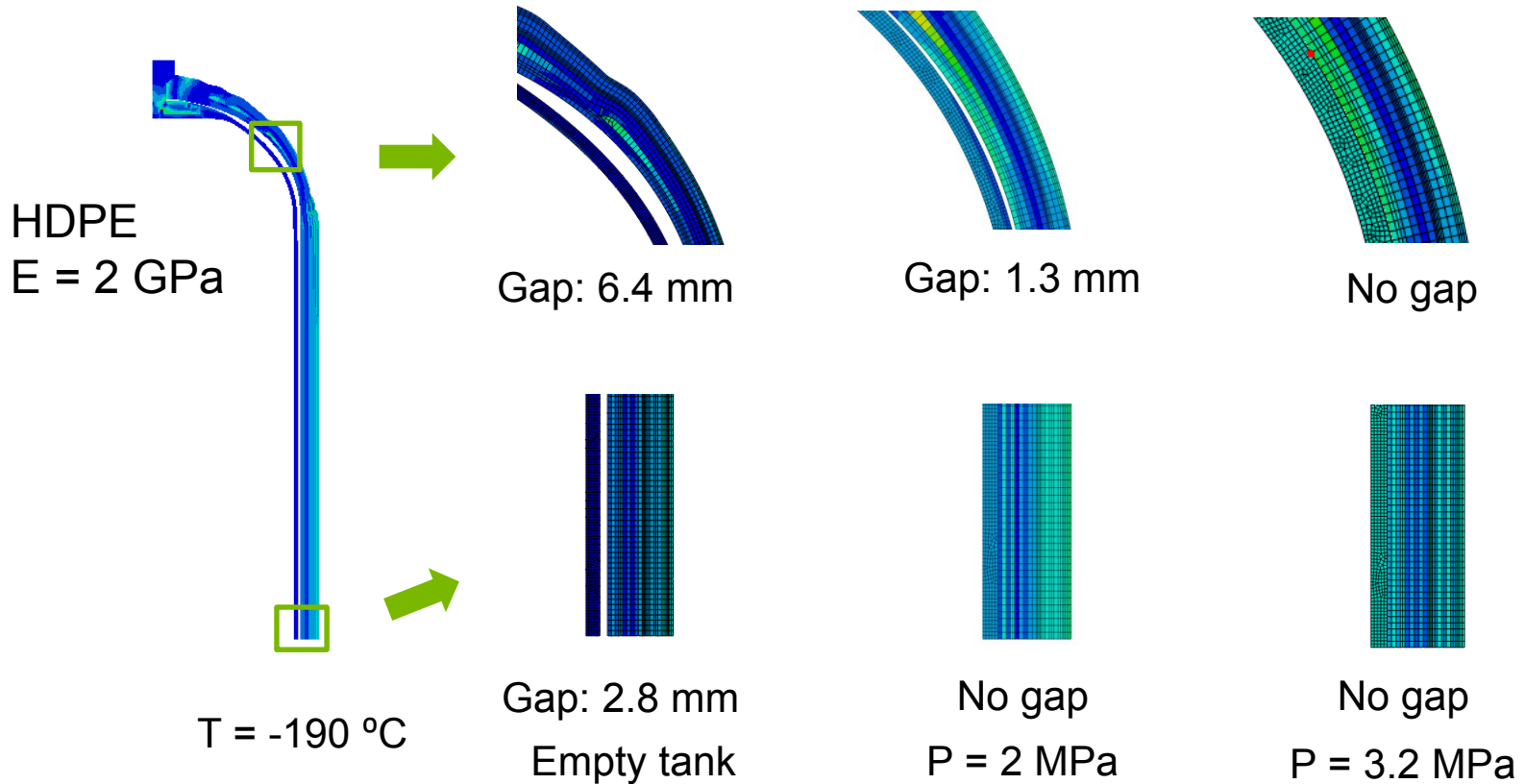

# Stress Concentration at Liner/Boss Interface

ABAQUS simulations of a full-sized tank with HDPE liner ( $E = 2 \text{ GPa}$ ) reveal high stress concentration region at the interface corners

- Simulation results at  $P = 2 \text{ MPa}$ 
  - Compared to peak stress at  $25^\circ\text{C}$ , 25-fold increase at  $-190^\circ\text{C}$  due to CTE mismatch between HDPE liner and Al-6061
  - Peak stress is below 105-MPa tensile strength of liner
- Simulation results at  $P = 63 \text{ MPa}$ 
  - Peak stress at  $-190^\circ\text{C}$  approaches the tensile strength of liner
- For comparison, testing of two Type-4 tanks at  $\text{LN}_2$  temperature by Hexagon Lincoln showed that both tanks leaked at  $<28 \text{ MPa}$  and cracks occurred at the liner/boss interface

## von Mises Stress Contours

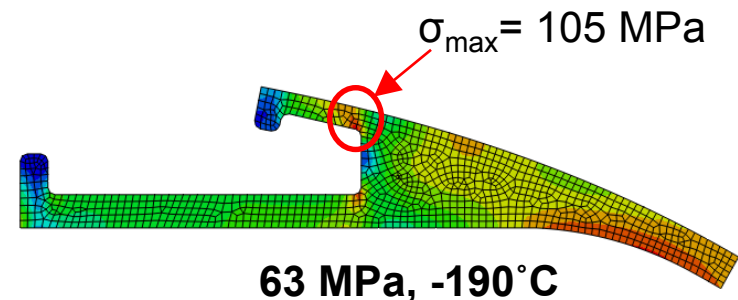
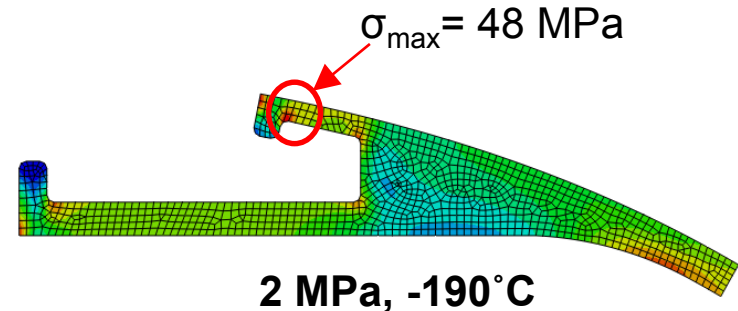
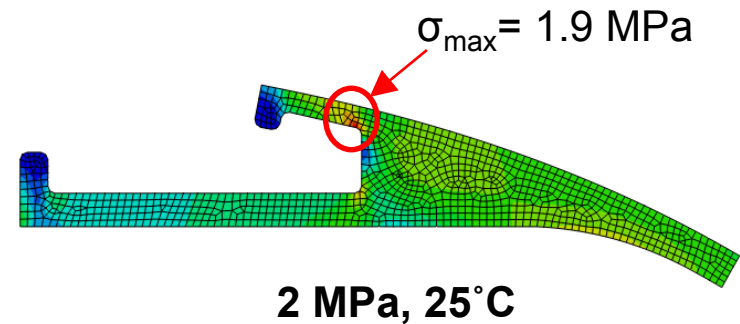



# Cold Gas Storage Option: Off-Board Analysis

- Netting analysis calibrated with ABAQUS model to determine weight and volume for 2.25 safety factor and 5500 pressure cycles, and constrained by ISO container dimensions and trailer payload
- Onboard conditions: baseline (700 bar, 300K), cold gas (400 bar, 200 K)
- Baseline tubes require significantly more CF than cold gas tubes

|                               | Unit           | Trailer Tube |            | Cascade Storage Tube |            |
|-------------------------------|----------------|--------------|------------|----------------------|------------|
|                               |                | Base Case    | Cold Gas   | Base Case            | Cold Gas   |
| Type                          |                | 4            | 3          | 3                    | 3          |
| Nominal Storage Pressure      | bar            | 340          | 340        | 945                  | 534        |
| Nominal Storage Temperature   | K              | 300          | 83         | 300                  | 116        |
| H <sub>2</sub> Stored         | kg             | 116          | 137        | 46                   | 45.3       |
| H <sub>2</sub> Volume         | m <sup>3</sup> | 5.1          | 2.25       | 0.96                 | 0.77       |
| Carbon Fiber Composite Weight | kg             | <b>1148</b>  | <b>425</b> | <b>712</b>           | <b>278</b> |
| Total Tube Weight             | Kg             | 1421         | 1483       | 958                  | 856        |

Trailer tube, cold gas  
\$25,637

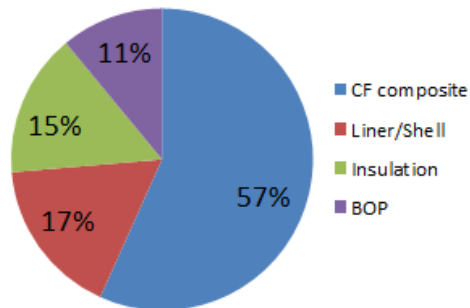

Trailer tube, base case  
\$41,588

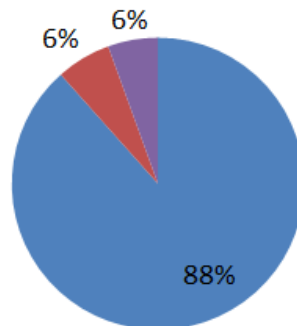

Cascade tubes

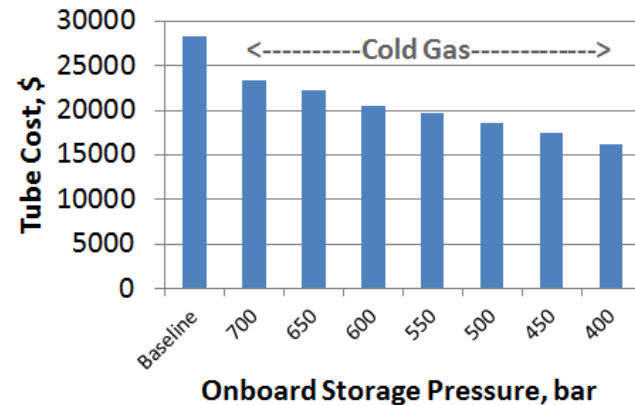

# Off-Board Analysis: Energy Consumption and Fuel Cost

- Off-board primary energy consumption for cold gas option is equivalent to ~60% of H<sub>2</sub> LHV, and is ~73% higher than for baseline
  - Cooling with LN<sub>2</sub>, GCtool analysis: 7 kg LN<sub>2</sub> is needed per kg H<sub>2</sub>
  - Compression energy is lower because of lower gas temperature
- Off-board cost for cold gas is \$0.18 - \$0.31/kg-H<sub>2</sub> higher than baseline
  - Significantly higher at the gas terminal
  - Lower costs at forecourt and tube trailer
- Storage pressure of cold gas has only small effect on off-board energy consumption and fuel cost (<7% variation between 400 and 700 bar)

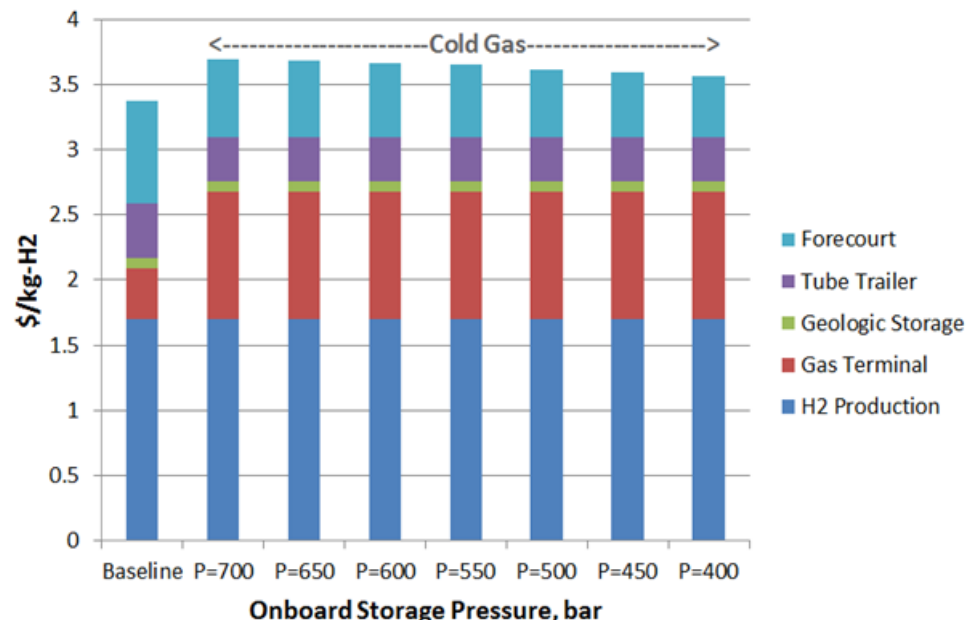
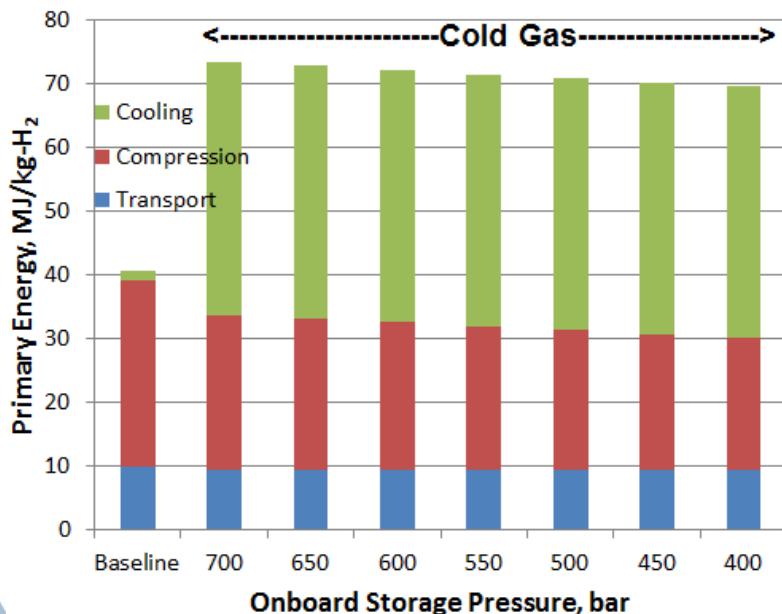

# WTT Efficiency

- WTT efficiency for cold gas storage < 50%, ~6 percentage points lower than baseline because of cooling requirement
- WTT efficiency can improve by 1.3 percentage points for baseline and 0.2 – 0.7 percentage points for cold gas if Linde ionic compressor is used at forecourt

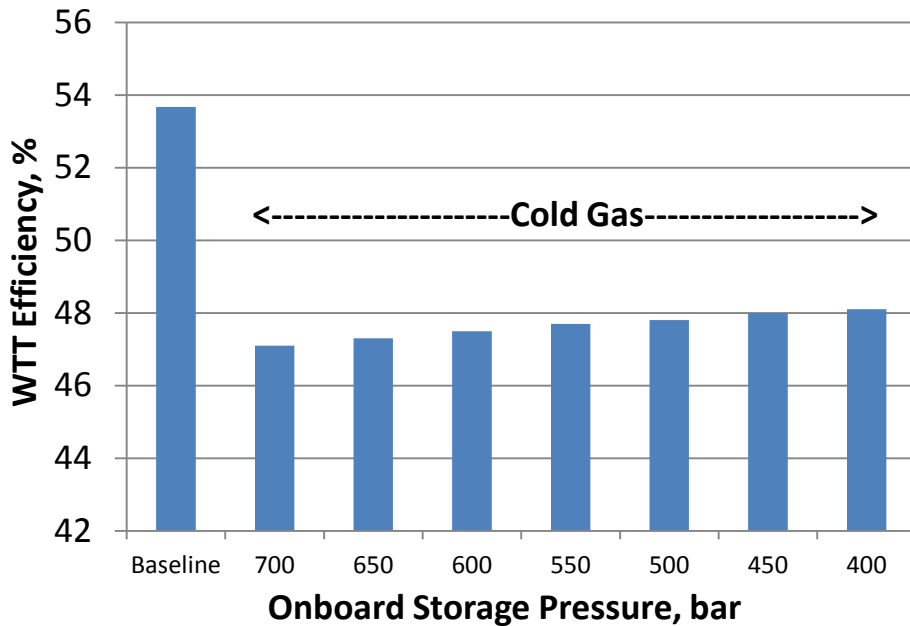

| Process/Process Fuels                           | Nominal Value                | Source/Comments   |
|---|------------------------------|---|
| Electricity production                          | 35.1% thermal efficiency     | EIA projected U.S. grid 2015, inclusive of 6.5% transmission loss |
| North American natural gas production           | 93.5 % efficiency            | GREET   |
| H <sub>2</sub> production by SMR                | 73% efficiency               | Advanced industrial SMR plant                                     |
| Pipeline transmission                           | 50 bar                       | Pressure drop   |
| H <sub>2</sub> compressor isentropic efficiency | 88% central<br>65% forecourt | HDSAM   |
| H <sub>2</sub> cooling with LN <sub>2</sub>     |                              |   |
| - LN <sub>2</sub> production                    | 0.55 kWh/kg                  | Large plants  |
| H <sub>2</sub> delivery by tube trailers        | up to 9 tubes/trailer        | Weldship  |
| - Tube pressure                                 | 340 bar                      | CF overwrap for reinforcement                                     |
| - Temperature                                   | 83 K                         | Requires insulation   |
| - Water volume                                  | 2.254 m <sup>3</sup>         | Weldship  |
| - H <sub>2</sub> capacity per tube              | 135 kg                       |   |
| - RT distance/fuel economy                      | 100 km/ 6 mpg                | HDSAM   |

# Summary of Cold Gas Storage Option

- Cold gas storage option has the potential to meet the gravimetric capacity target but unlikely to meet the volumetric capacity target (little change versus baseline)
- Fuel cost is ~5% higher than baseline, but onboard system cost is ~20% lower (50% savings in CF requirement, offset by added insulation and shell costs)
- WTP efficiency for cold gas storage is ~6 percentage points lower than baseline and is unlikely to meet DOE target

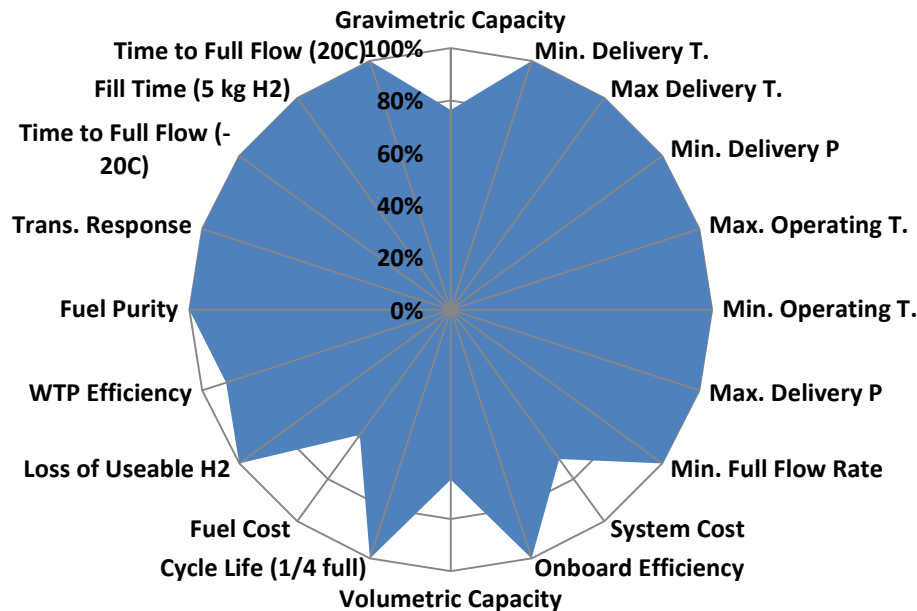

700 bar, 300 K

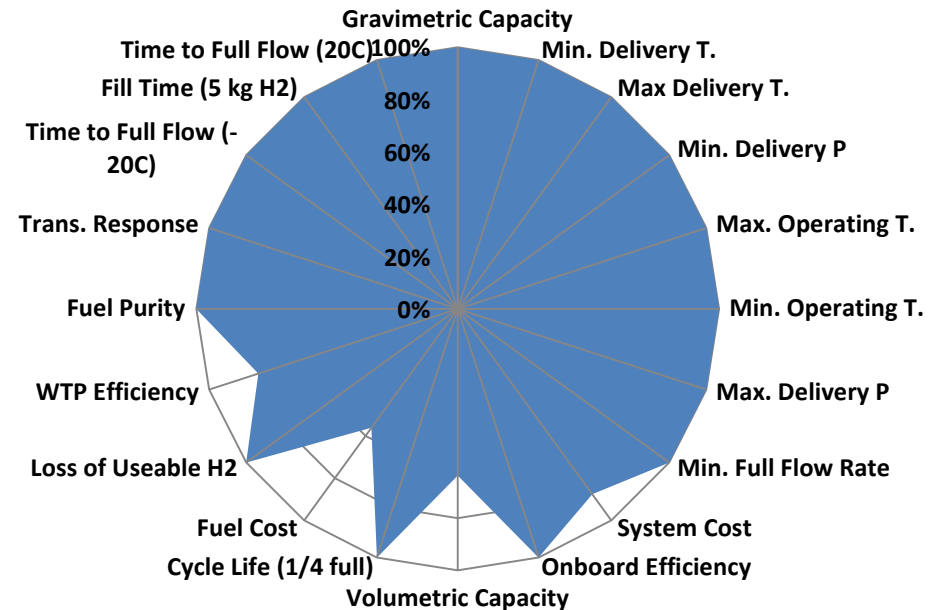

400 bar, 200 K

# Chemical Hydrogen Storage Materials

---

Class of storage materials that release hydrogen through a non-equilibrium process and, therefore, cannot be regenerated by reacting the dehydrogenated product with H<sub>2</sub> gas.

- Require off-board regeneration using electrochemical or catalytic processes
1. Negative free energy of decomposition
    - Thermodynamically unstable at room temperature and are stabilized by extremely slow kinetics (alane, ammonia borane) or by other chemical means (addition of 3% NaOH to aqueous NaBH<sub>4</sub>)
  2. Positive free energy of decomposition
    - Stable at room temperature but can be decomposed at elevated temperatures
    - Require a catalyst for adequate kinetics at low temperatures
    - APCI patent identifies many cyclic hydrocarbons including perhydrogenated n-ethyl carbazole
    - On-board storage system efficiencies may be low since  $\Delta H > T\Delta S$ , i.e.,  $\Delta H > 38.8 \text{ kJ/mol}$  for  $\Delta S = 130.2 \text{ J/mol.K}$
    - High off-board efficiencies may be possible since the regeneration reaction is exothermic



# Off-Board Regeneration of Chemical Hydrogen Storage Materials

Well-to-tank efficiency ( $\eta_{WTT}$ )\*

- Ratio of LHV of H<sub>2</sub> produced to the primary energy ( $Q^f$ ) consumed in producing (subscript  $p$ ), delivering (subscript  $d$ ) and storing (subscript  $s$ ) H<sub>2</sub>

$$\eta_{WTT} = \frac{\Delta H_{LHV}}{Q_p^f + Q_d^f + Q_s^f} \quad Q_r^f = Q_d^f + Q_s^f$$

$\Delta G$  determines the off-board regeneration efficiency. Materials with large negative  $\Delta G$  require elaborate regeneration processes with high demands for primary energy.

- WTT efficiency: 16-21% for NaBH<sub>4</sub> (-75 kJ/mol), 8-18% for AB (-45 kJ/mol), 24-31% for AlH<sub>3</sub> (-32 kJ/mol), 60-63.2% for n-ethyl carbazole

|                   | $\Delta G^0$<br>(298 K)    | $\Delta H^0$<br>(298 K) | $\Delta S^0$<br>(298 K) | Regen<br>Primary<br>Energy | WTT<br>Efficiency | Comments                |
|-------------------|----------------------------|-------------------------|-------------------------|----------------------------|-------------------|-------------------------|
|                   | kJ/mol-H <sub>2</sub>      | kJ/mol-H <sub>2</sub>   | J/mol.K                 | MJ/kg-H <sub>2</sub>       | %                 |                         |
| NaBH <sub>4</sub> | -74.75                     | -57.75                  | 57                      | 386                        | 21.3              | AnH-AqH                 |
|                   | Hydrolysis Reaction        |                         |                         | 467                        | 18.6              | AqH-AqH                 |
|                   |                            |                         |                         | 500                        | 17.7              | An-Aq                   |
|                   |                            |                         |                         | 591                        | 15.6              | Aq-Aq                   |
| AlH <sub>3</sub>  | -32                        | 6.6                     | 131                     | 323                        | 24.0              | TMAA no waste heat      |
|                   | Thermolysis Reaction       |                         |                         | 210                        | 31.0              | 50% waste heat          |
| AB                | -44.6                      | -33                     | 39                      | 485                        | 18.1              | Benzophenone            |
|                   | Thermolysis Reaction       |                         |                         | 1319                       | 8.0               | Bayer                   |
|                   |                            |                         |                         | 789                        | 12.4              | PCUK                    |
| CBN               | -41.8                      | -18.97                  | 77                      | 596                        | 15.5              | MeOH/NaAlH <sub>4</sub> |
|                   | Thermolysis Reaction       |                         |                         | 217                        | 30.5              | Formic acid             |
| LCH2              | 8.5                        | 47.3-53.6               | 130.2                   | 24                         | 60.0              | Trickle bed reactor     |
|                   | Perhydro N-ethyl Carbazole |                         |                         | 14                         | 63.2              | Electricity production  |

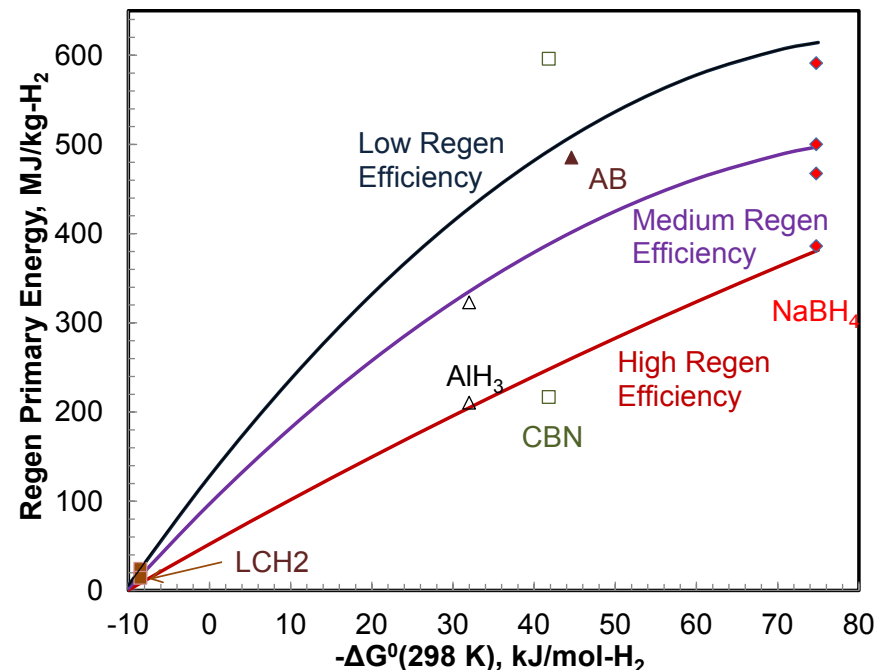

# WTT Efficiency Correlation

Analyzed a H<sub>2</sub> production, delivery and regeneration fuel cycle for NA NG and US electric grid: 68% SMR efficiency without credit for steam co-production, 77% with steam export.

- WTT correlations for high, medium and low regeneration efficiencies

Materials with positive free energy of decomposition

- May meet the 60% WTT efficiency target if  $\Delta G^0(298\text{ K}) > 1.6\text{ kJ/mol}$ .

Materials with negative free energy of decomposition

- Even with steam export, 60% WTT efficiency not possible
- With steam export, minimum  $\Delta G^0(298\text{ K})$  limited to -1.5 kJ/mol for 55% WTT efficiency and -6.4 kJ/mol for 50% WTT efficiency

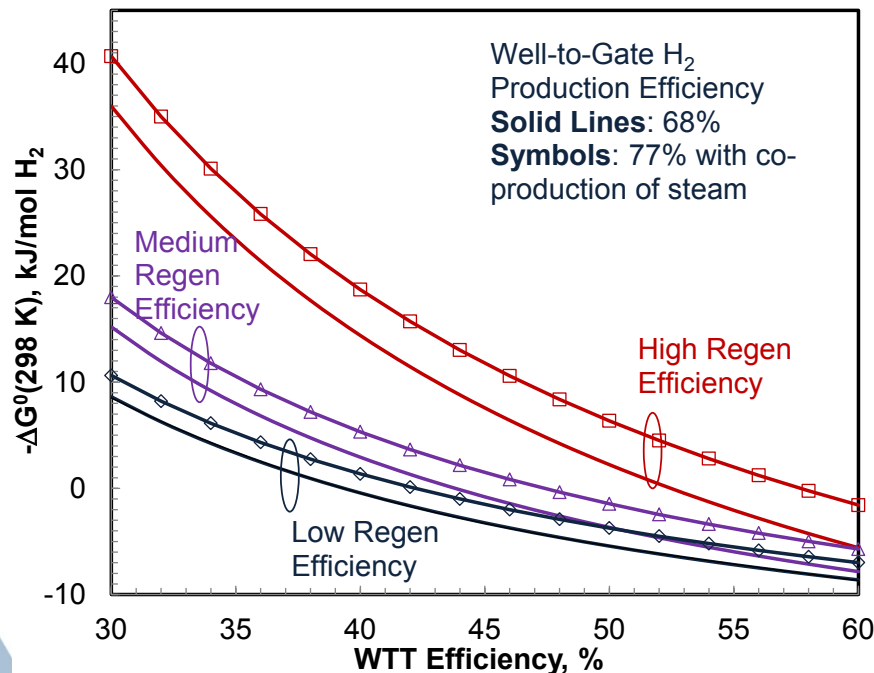

Definitions of Free Energy and Enthalpy of Decomposition

$$AH_m = AH_n + (m-n)/2 H_2$$

$$\Delta G = \left(\frac{2}{m-n}\right)[\Delta G_f(AH_n) - \Delta G_f(AH_m)]$$

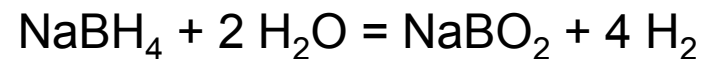

$$\Delta G = 1/4[\Delta G_f(\text{NaBO}_2) - \Delta G_f(\text{NaBH}_4) - 2\Delta G_f(\text{H}_2\text{O})]$$

\*60% efficiency target is for well-to-engine (WTE) efficiency, not WTT efficiency

# Bounding Thermodynamic and Kinetic Properties

Desired thermodynamic properties of materials for which the WTT efficiencies may be between 50 to 60%

- Over the narrow range of desired  $\Delta G^0(298\text{ K})$ , exothermic materials are unsuitable if  $\Delta S$  is between the expected range 80 – 130 J/mol.K
- Materials that decompose above the FCS coolant temperature and require a burner may not be acceptable since the on-board system efficiency is quite low for  $\Delta H$  between 20 and 40 kJ/mol- $\text{H}_2$

Desired kinetic properties of materials that decompose at 60 – 80°C

- Likely a catalytic process, otherwise the material would have short shelf life and may not meet the 0.05 g- $\text{H}_2$ /h/kg stability target at room temperature
- Non-equilibrium decomposition kinetics that is independent of back pressure, otherwise the buffer tank would need to be refueled with gaseous  $\text{H}_2$

|                                     |        | $\Delta S = 130\text{ J/mol.K}$ |       |       | $\Delta S = 105\text{ J/mol.K}$ |      |       | $\Delta S = 80\text{ J/mol.K}$ |      |       |
|-------------------------------------|--------|---------------------------------|-------|-------|---------------------------------|------|-------|--------------------------------|------|-------|
| WTT Efficiency                      |        | 60%                             | 55%   | 50%   | 60%                             | 55%  | 50%   | 60%                            | 55%  | 50%   |
| $\Delta G^0(298\text{ K})$          | kJ/mol | 1.6                             | -1.5  | -6.4  | 1.6                             | -1.5 | -6.4  | 1.6                            | -1.5 | -6.4  |
| $\Delta H$                          | kJ/mol | 40.3                            | 37.2  | 32.3  | 32.9                            | 29.8 | 24.9  | 25.4                           | 22.3 | 17.4  |
| $P_{\text{H}_2}(60^\circ\text{C})$  | atm    | 2.9                             | 8.9   | 52.1  | 2.1                             | 6.5  | 38.0  | 1.5                            | 4.7  | 27.7  |
| $P_{\text{H}_2}(70^\circ\text{C})$  | atm    | 4.4                             | 13.2  | 73.3  | 3.0                             | 8.9  | 49.4  | 2.0                            | 6.0  | 33.3  |
| $P_{\text{H}_2}(150^\circ\text{C})$ | atm    | 64.3                            | 155.3 | 625.2 | 26.5                            | 63.9 | 257.2 | 10.9                           | 26.3 | 105.8 |



# On-Board Chemical Hydrogen Storage System

Flow system to enable refueling of partially empty tanks

- Volume exchanged tanks for compactness
- Hydrogen buffer for start-up and fast transients
- Reactor operates at elevated pressure, reaction kinetics independent of back pressure, reactor size determined by reaction kinetics and heat transfer
- Fuel may be liquid, slurry or solution

## System with burner\*

- 50-kW microchannel HEX burner
- HTF coolant separates burner & reactor

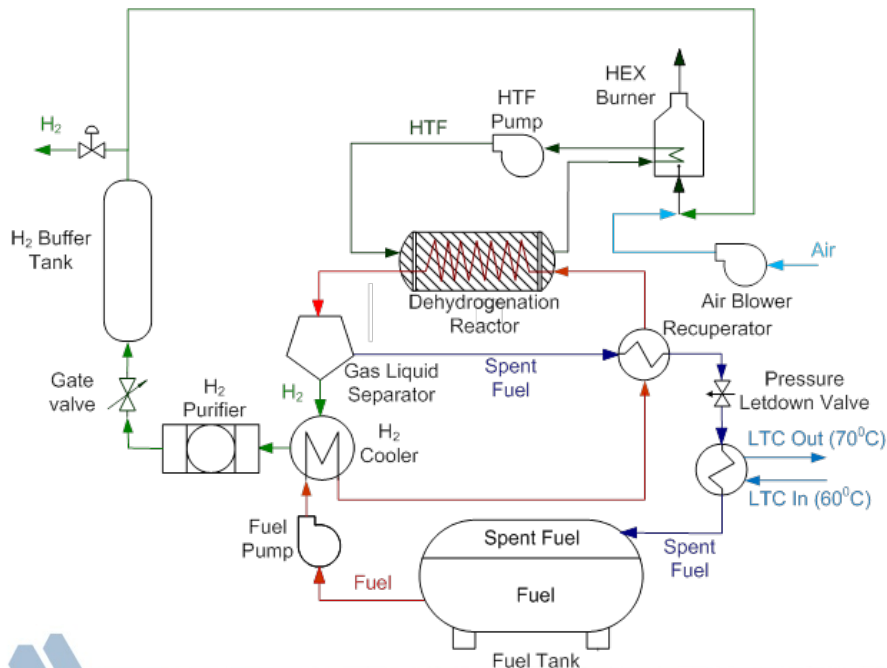

## System without burner

- Thermally integrated with FCS
- Mitigates FCS heat rejection problem

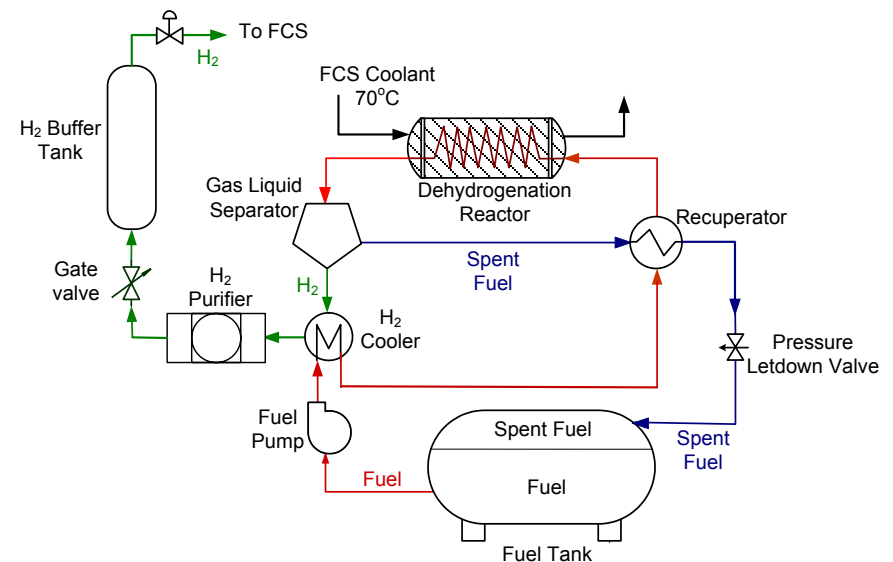

# Storage System without Burner: Buffer H<sub>2</sub> Requirements

H<sub>2</sub> buffer capacity for FCS startup from -40°C\*

- Buffer to supply H<sub>2</sub> until the fuel cell and the reactor reach the fuel decomposition temperature (70°C)
- Buffer replenished with excess H<sub>2</sub> released from fuel during normal operation when the stack coolant is at its peak temperature (80°C)
- Stack: 2 kW/kg specific weight, 0.5 kJ/kg.K average C<sub>p</sub>
- Reactor: Thermal mass during startup includes weights of HX tubes, reactor walls, and coolant, 0.5 kJ/kg.K average C<sub>p</sub>

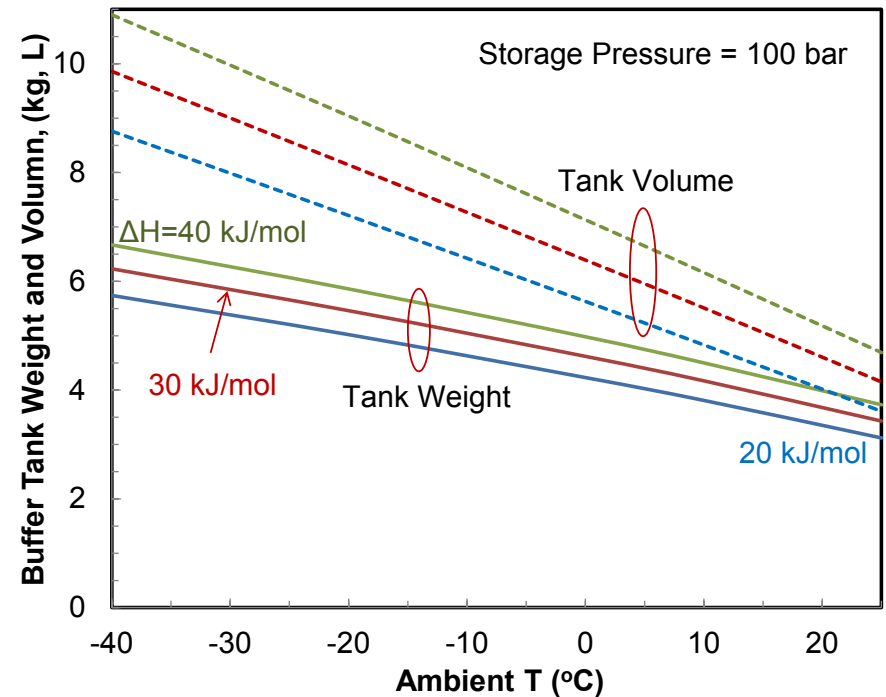
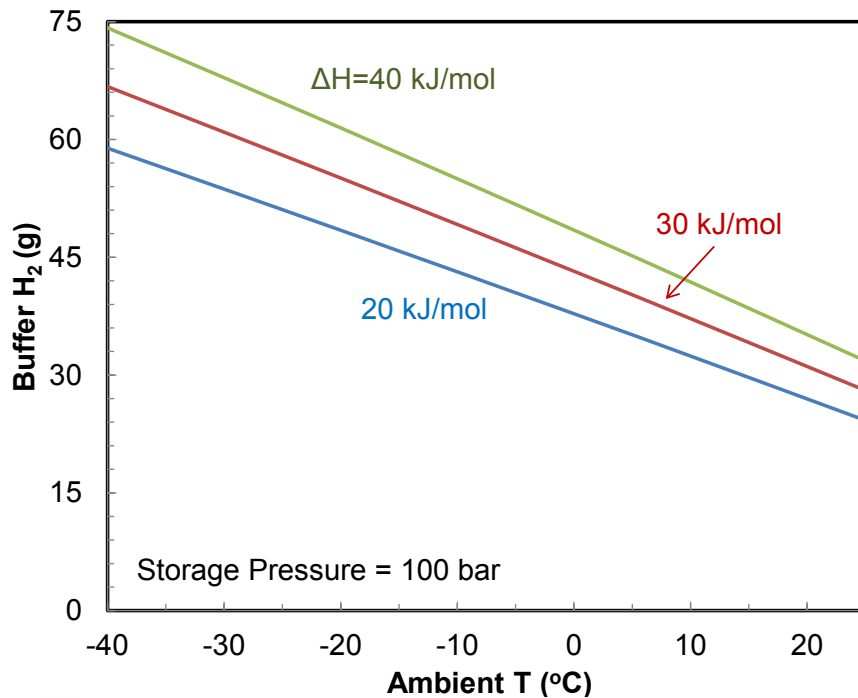

# Storage System without Burner: Baseline Material Targets

Thermodynamically mildly stable or unstable materials at room temperature that decompose at 70-80°C, 100 bar backpressure

|                                     |                              | Units                 | Reference Values | Range of Values | Comments and Relevant Targets               |
|-------------------------------------|------------------------------|-----------------------|------------------|-----------------|---|
| <b>Chemical Storage Material</b>    | Free Energy of Decomposition | kJ/mol                | 1.6              | -6.4 to 1.6     | 60% WTE efficiency                          |
|                                     | Enthalpy of Decomposition    | kJ/mol                | 40.0             | 20 to 40        | 90% on-board system efficiency              |
|                                     | Fuel Hydrogen Capacity       | wt% H <sub>2</sub>    | 9.6              | 8.4 - 9.6       | 5.5 wt% system gravimetric capacity         |
|                                     | Fuel Volumetric Capacity     | g-H <sub>2</sub> /L   | 68.5             | 61 - 71.5       | 40 g/L system volumetric capacity           |
|                                     | Decomposition Kinetics       | s                     | 5                | TBD             | Time for 95% conversion at 70°C             |
|                                     | Fuel Stability               | g/h/kg-H <sub>2</sub> | 0.05             |                 | H <sub>2</sub> loss target                  |
| <b>Operating Temperatures</b>       | Dehydrogenation Reactor      | °C                    | 70               | TBD             | 1.6 g/s minimum full flow of H <sub>2</sub> |
|                                     | Heat Transfer Fluid (HTF)    | °C                    | 70               | 70 - 80         |   |
|                                     | Spent Fuel Cooler            | °C                    | 50               | 25 - 50         |   |
| <b>Operating Pressures</b>          | Storage Pressure             | bar                   | 100              | 50 - 200        |   |
|                                     | Minimum Delivery Pressure    | bar                   | 5                |                 | DOE target                                  |
| <b>H<sub>2</sub> Flow Rates</b>     | Refueling Rate               | kg/min                | 1.5              |                 | Not relevant for liquid fuels               |
|                                     | Minimum Full Flow Rate       | g/s                   | 1.6              |                 | DOE target                                  |
| <b>Buffer H<sub>2</sub> Storage</b> | Storage Pressure             | bar                   | 100              | 50 - 200        | Start-up from -40°C                         |
|                                     | Buffer Storage Capacity      | g-H <sub>2</sub>      | 74               | 59 - 74         |   |

# Storage System without Burner: Sensitivity Analysis

On-going model testing and validation. As such, results are subject to uncertainties in shell-side heat transfer correlation

- $\Delta H$ : Determines reactor heat transfer area and fuel residence time. Reduces heat load on the FCS radiator (advantageous).
- Storage pressure: Determines the volume of the buffer. Volumetric material capacity target increases greatly if material decomposes at 25 bar back pressure.
- Activation energy ( $E_A$ ): Fitting parameter.
- Isothermal conversion time ( $\tau_K$ ): Actual decomposition rate may be controlled by mass transfer (not yet considered in model) and heat transfer as  $\tau_K$  is reduced.

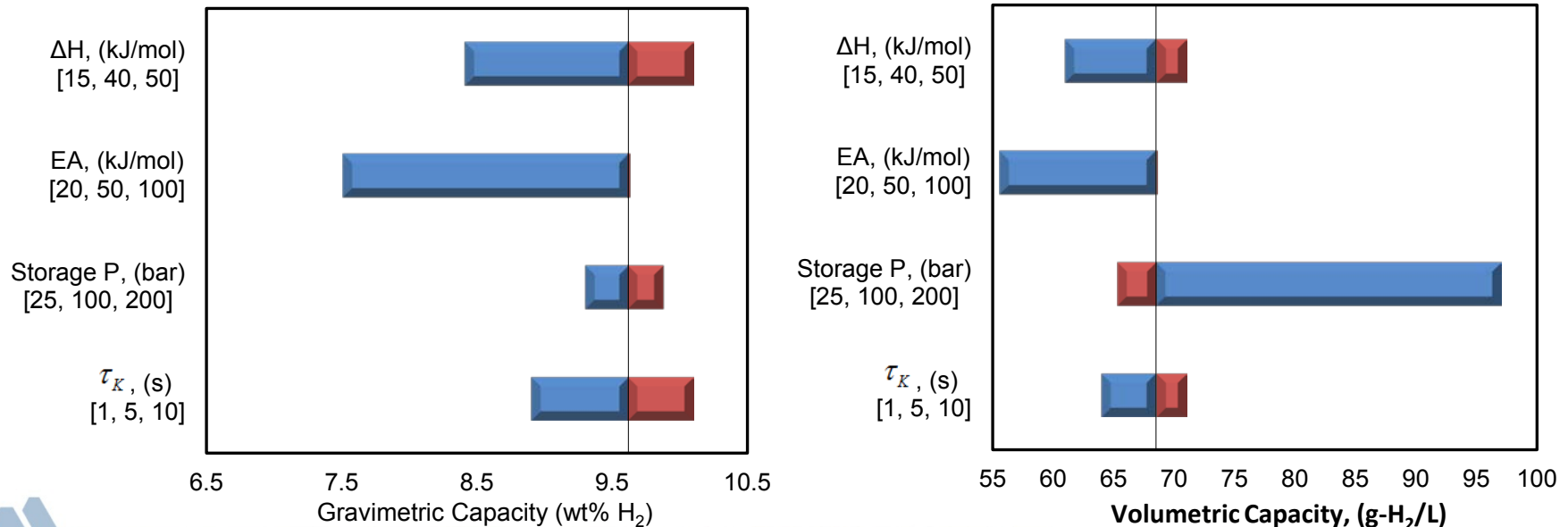

## FY2015 Collaborations

|                                 |   |
|---------------------------------|---|
| Physical Storage                | PNNL Team: Liner properties at cryogenic temperatures (ST101)   |
| Metal Hydrides                  | SRNL, UTRC: Material properties of metal hydrides, reverse engineering, acceptability envelope                              |
| Sorbents                        | SRNL, UM: Material properties of sorbents, reverse engineering, acceptability envelope (ST044, ST010)                       |
| Chemical Hydrogen               | LANL, PNNL: Material properties of chemical hydrogen storage materials, reverse engineering, acceptability envelope (ST007) |
| Off-Board Fuel Cycle Efficiency | ANL (H2A Group), ANL (HDSAM)  |
| Off-Board Cost                  | ANL (H2A Group), ANL (HDSAM)  |
| On-Board Cost                   | SA  |
| SSAWG                           | DOE, HSECoE (LANL, PNNL, SRNL, UM), OEMs, Tank Manufactures, UH, SA   |

- Argonne develops the storage system configuration, determines performance, identifies and sizes components, and provides this information to SA for manufacturing cost studies



## Physical Storage

- Apply ABAQUS model to support the on-going tank projects (graded carbon fiber composite structure, non-geodesic winding, alternate winding patterns and fibers, low-cost glass fibers, CF composites at cryogenic temperatures)
- Validate ABAQUS finite element model against experimental and field data for cold gas storage (collaboration with PNNL led project)
- Renew collaboration with LLNL to extend and validate ANL models to thin-walled high fiber fraction 700-bar pressure vessels at cryogenic temperatures (120 K)

## Material Based Storage

- Analyze decomposition behavior and reactor heat transfer of chemical storage materials using LANL and PNNL data for  $\text{AlH}_3$  and AB slurries as model fuels
- Analyze uptake and reactor heat transfer in powder and compacted sorbents using HSECoE data for Hex-Cell and MATI prototypes
- Determine favorable properties of unstable room-temperature metal hydrides
- Provide system-level support to new projects on material discovery

Document models and publish papers on material properties in IJHE

# Project Summary

|                 |   |
|-----------------|---|
| Relevance:      | Independent analysis to evaluate on-board and off-board performance of materials and systems  |
| Approach:       | Develop and validate physical, thermodynamic and kinetic models of processes in physical and material-based systems<br>Address all aspects of on-board and off-board targets including capacities, rates and efficiencies   |
| Progress:       | Determined the minimum pressure (32 bar) to avoid liner separation at near LN <sub>2</sub> temperatures (-190°C) in Type-4 tanks<br>Evaluated liner failure modes at -190°C: stress concentration at liner/boss interface, pressure cycling induced fatigue failure<br>Determined the WTT efficiency (48%), fuel cost penalty (5%), system cost reduction (20%) with cold gas storage option<br>Reverse engineering to determine the desired properties of chemical storage materials: $\Delta G^0(298\text{ K}) > -6.4\text{ kJ/mol}$ , $\Delta H$ between 20 and 40 kJ/mol-H <sub>2</sub> , 9.6 wt% H <sub>2</sub> and 68.5 g-H <sub>2</sub> /L material capacities, decomposition temperature below 80°C |
| Collaborations: | SSAWG, HSECoE, Ford, LANL, PNNL, SA, SRNL   |
| Future Work:    | Propose, analyze and validate methods of reducing cost of CF wound storage tanks<br>Validate AlH <sub>3</sub> and AB decomposition models using LANL and PNNL data, and sorption model using data for Hex-Cell and MATI prototypes from HSECoE  |

## Reviewer Comments

---

Generally favorable reviews with the following comments/recommendations

- Additional assumption justifications and sensitivity analysis would be useful, such as recognizing tolerance band.
- Continue to pursue opportunities to validate results based on empirical testing and existing hardware.
- Emphasis should be placed on providing guidance on the requirements of future materials to meet the overall system targets
- Modeling of composite impact damage for compressed hydrogen storage tanks is encouraging and should be especially useful.
- Keep publishing results in appropriate peer-reviewed journals in a timely manner.

FY15 work scope consistent with above recommendations

- ✓ Assumption justifications and sensitivity analysis were included in recent work on sorbent and chemical hydrogen storage materials
- ✓ Ongoing work to validate sorbent and chemical hydrogen storage model results with test data being acquired by the HSECoE.
- ✓ Guidance on material requirements of future materials was the main focus of reverse engineering work on chemical hydrogen, sorbents, and metal hydrides.
- ✓ Results of compressed hydrogen storage tanks (liner, CF usage, impact damage) were discussed with PNNL for potential testing to address key issues.
- ✓ Published two journal papers and another one being reviewed for publication.





# Technical Back-Up Slides



## Journal Publications

R.K. Ahluwalia, J.K. Peng, and T.Q. Hua, “Bounding Material Properties for Automotive Storage of Hydrogen in Metal Hydrides for Low-Temperature Fuel Cells,” *International Journal of Hydrogen Energy*, 39 (2014) 14874-14886.

R.K. Ahluwalia, J.K. Peng, and T.Q. Hua, “Sorbent Material Properties for On-board Hydrogen Storage for Automotive Fuel Cell Systems,” accepted for publication in *International Journal of Hydrogen Energy*, 2015.

H.S. Roh, T.Q. Hua, R.K. Ahluwalia, and H.S. Choi, “Impact Damages on Type IV Hydrogen Storage Tanks for Fuel Cell Vehicles,” Submitted to *International Journal of Hydrogen Energy*, 2014.

## Book Chapters

R.K. Ahluwalia, J.K. Peng, and T.Q. Hua, “Cryo-compressed Hydrogen Storage,” *Compendium of Hydrogen Energy*, Elsevier, submitted November 2014

## Presentations

R.K. Ahluwalia, J.K. Peng, and T.Q. Hua, “Chemical Hydrogen Storage Material Requirements for Automotive Fuel Cells,” Storage System Analysis Working Group Meeting, Webinar, September 10, 2014.

R.K. Ahluwalia, J.K. Peng, and T.Q. Hua, “Off-Board Considerations,” DOE Materials-Based Hydrogen Storage Summit, Golden, CO, January 27, 2015.

R.K. Ahluwalia, T.Q. Hua, J.K. Peng, and H.S. Roh, “System Level Analysis of Hydrogen Storage Options,” DOE Materials-Based Hydrogen Storage Summit PI Meeting, Golden, CO, January 28, 2015.

R.K. Ahluwalia, T.Q. Hua, J.K. Peng, and H.S. Roh, “System Level Analysis of Hydrogen Storage Options,” Hydrogen Storage Tech Team Meeting, Southfield, MI, February 19, 2015.

# Fatigue Considerations

- In ambient temperature Type 4 tanks, the HDPE liner experiences compressive stress during pressure cycling, therefore fatigue is not an issue.
- At -190°C, pressure cycling induces tensile stress in the liner
- Fatigue load ( $\sigma$ ),  $\sigma_{\text{mean}} = (\sigma_{\text{max}} + \sigma_{\text{min}})/2 = 30 \text{ MPa}$ ,  $R = \sigma_{\text{min}}/\sigma_{\text{max}} = 0.4$
- Need SN curves for HDPE at low temperatures to determine if fatigue is a concern
- For 5500 pressure cycles at RT, maximum allowable stress for HDPE PE-100 grade is ~20 MPa

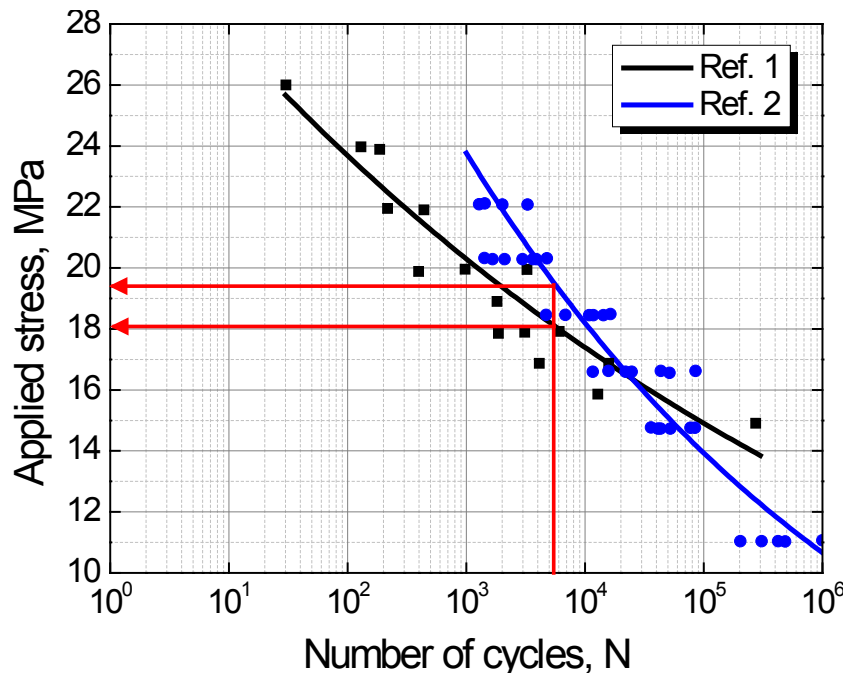

## Test Conditions

### Ref. 1

$\sigma_{\text{max}} = 15 - 26 \text{ MPa}$  (9 stress levels)  
 $R=0$ , Frequency = 2 Hz

### Ref. 2:

$\sigma_{\text{max}} = 11 - 22 \text{ MPa}$  (6 stress levels)  
 $R=0.1$ , Frequency = 5 Hz

# Off-board H<sub>2</sub> Cold Gas Delivery Analysis

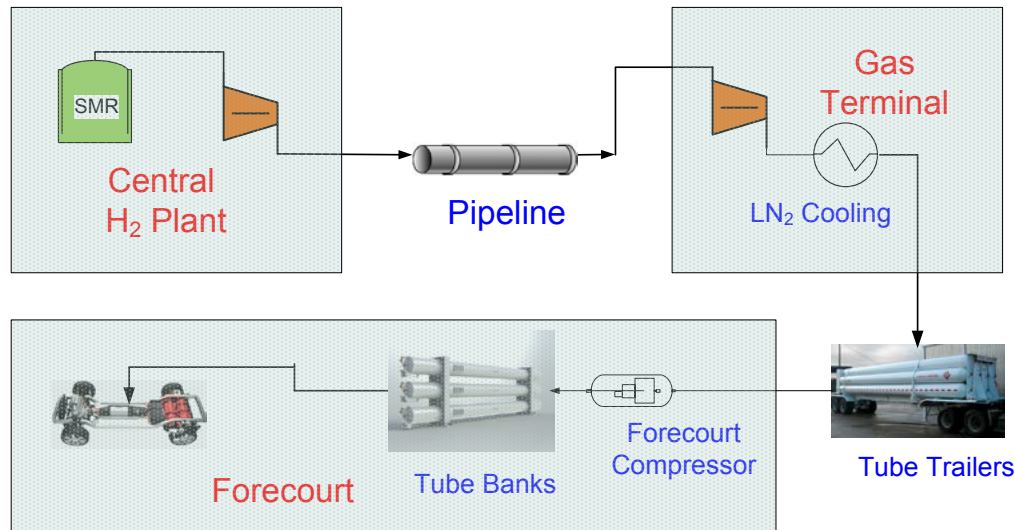

- H<sub>2</sub> produced by SMR, transmitted via pipeline to gas terminal at city gate
- Compressed to 340 bar at gas terminal, cooled nominally to 90 K\* using LN<sub>2</sub> and transported to forecourt by insulated Type 3 tube trailers
  - LN<sub>2</sub> production plant co-locates with gas terminal
- Compressed to 1.35X nominal storage pressure and stored in insulated Type 3 tube banks at forecourt
- HDSAM (2020 delivery scenario) analysis
  - Sacramento, 15% FCEV share, 115 stations, 1000 kg-H<sub>2</sub>/day/station

\*83 K actual temperature to account for heat gain in off-board storage tanks

# System with Burner: Operating Temperatures and Efficiencies

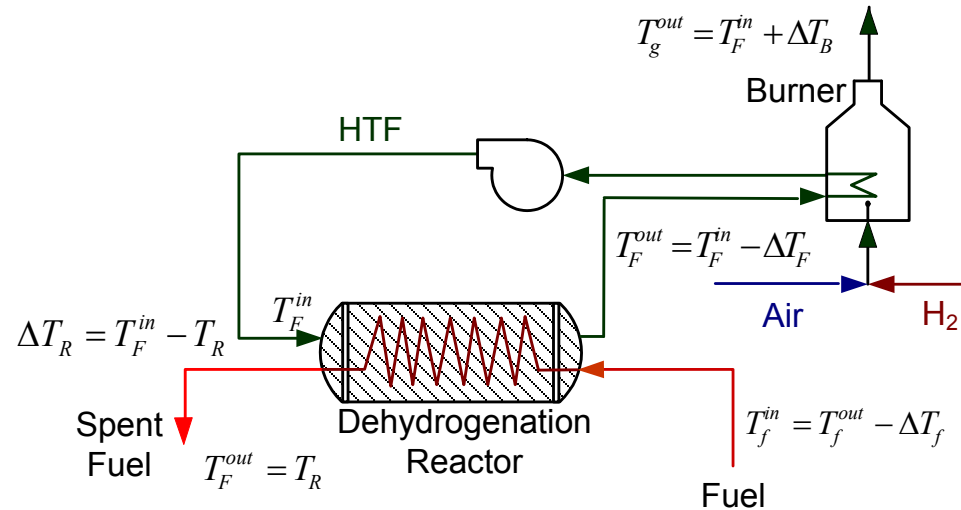

## Operating Temperatures

- $T_R$ : Reactor temperature ( $T_R = T_{f,out}$ )
- $\Delta T_f$ : Fuel temperature rise ( $\Delta T_f = T_{f,out} - T_{f,in}$ )
- $\Delta T_F$ : Drop in HTF temperature across the reactor ( $\Delta T_F = T_{F,in} - T_{F,out}$ )
- $\Delta T_R$ : Reactor approach temperature ( $\Delta T_R = T_{F,in} - T_{f,out}$ )
- $\Delta T_B$ : Burner approach temperature ( $\Delta T_B = T_{g,out} - T_{F,in}$ )

## Efficiencies

- $\eta_R$ : Reactor efficiency,  $1 - (Q_R / \text{LHV of } H_2 \text{ released})$
- $\eta_B$ : Burner efficiency
- $\eta_d$ : Drive cycle efficiency
- $\eta_{su}$ : Start-up efficiency
- $\eta_s$ : Storage system efficiency

## Additional Material Targets

- Fuel should remain liquid and be pumpable over the range of operating temperatures (-40°C to  $T_{FC}$ ).
- No solid phases should form as the fuel is decomposed.
- No gaseous products of decomposition other than H<sub>2</sub>.

|                                 | Parameter             | Reference Value | Comments   |
|---------------------------------|-----------------------|-----------------|--|
| <b>Physical Properties</b>      | Freezing Point        | Below -40°C     |  |
|                                 | Boiling Point         | Above 120°C     | Vapor pressure should be <1 mPa at 95°C                              |
|                                 | Viscosity             | TBD             | Fuel pumpable to 100 bar at -40°C                                    |
| <b>Stability</b>                | Shelf Life            | TBD             |  |
|                                 | Toxicity and Safety   | Non toxic       | Compliant with applicable ES&H standrads                             |
|                                 | H <sub>2</sub> Purity |                 | SAE J2719 and ISO/PDTS 14687-2 specifications                        |
| <b>Material Compatibility</b>   |                       |                 | Be compatible with materials rotinely used in automtive fuel systems |
| <b>Off-Board Regenerability</b> | WTT Efficiency        | 60%             | Practcal industrial methods for regeneration                         |
|                                 | Cycle Life            | TBD             |  |
|                                 | Cost                  | TBD             | As per DOE targets   |