

# Systems Engineering of Chemical Hydrogen, Pressure Vessel, and Balance of Plant for On-Board Hydrogen Storage

*K. Brooks (Presenter), M. Weimar, N. Klymyshyn, K. Alvine*

**DOE Hydrogen and Fuel Cells Program  
Annual Merit and Peer Evaluation Meeting**

**Washington, DC  
June 9, 2015**

**Technology Development Managers: Ned Stetson and Jesse Adams**

**U.S. Department of Energy**  
**Energy Efficiency and Renewable Energy**  
Bringing you a prosperous future where energy is clean, abundant, reliable, and affordable

*This presentation does not contain any proprietary, confidential, or otherwise restricted information*

# Overview

## ▶ Timeline

- Start: Feb. 2009
- Project End: Sept. 2015
  - End Phase 1: 2011
  - End Phase 2: 2013
  - End Phase 3: 2015
- Percent complete: 92%

## ▶ Budget

- FY15 Funding: \$150K
- FY14 Funding: \$600K
- Total DOE Project Funding: \$5508K
  - Revised down from \$6185K due to cuts during Phase II/III transition
  - DOE direct funded
  - No cost-share required for National Lab

## ▶ Barriers

- A. System Weight and Volume
- B. System Cost
- C. Efficiency
- D. Durability
- E. Charging / Discharging Rates
- G. Materials of Construction
- H. Balance of Plant (BOP) Components
- J. Thermal Management
- O. Hydrogen Boil-Off
- S. By-Product/Spent Material Removal

## ▶ Partners



# Relevance

## ► Overall Project Objective

- Develop hydrogen storage systems that meet DOE 2020 targets for light duty vehicles based on adsorbents and chemical hydrogen storage materials
- Develop engineering solutions to overcome material's deficiencies from the Materials Centers of Excellence
- Identify, develop and validate critical components either for performance, mass, volume, or cost.
- Develop models and simulation tools to predict the performance of materials that would be acceptable in engineered H<sub>2</sub> storage systems for light duty vehicles.

## ► This Reporting Period

- Developed prototype system and performed testing on LN<sub>2</sub> cooled wall tank concept to increase charging rate (**Barrier E: Charging Rates**)
- Developed cost models for HexCell and MATI cryo-adsorption systems (**Barrier B: System Cost**)
- Performed compressive tests of candidate polymer valve and seal materials under cryogenic temperatures after saturating with hydrogen (**Barrier H: Balance of Plant Components**)
- Finalized chemical hydrogen storage model, implemented it into the framework and placed it on the HSECoE website to allow evaluation of other materials (**Barrier C: System Efficiency**)

# Approach: Cryo-Adsorbent

LN <sub>2</sub> -Cooled Wall Tank						
Task	FY14		FY15			
	Q3	Q4	Q1	Q2	Q3	Q4
Design Tank	■	■				
Structural Analysis		■				
Fabrication			■	■		
Testing				■		
Analysis					■	

System Cost						
Task	FY14		FY15			
	Q3	Q4	Q1	Q2	Q3	Q4
Update costs for Hexcell/MATI	■	■				
BOP Cost Analysis			■			
Comparison to SA Estimate				■		
Finalize Costs					■	

Balance of Plant Design						
Task	FY14		FY15			
	Q3	Q4	Q1	Q2	Q3	Q4
Structural Analysis		■				
Polymer H <sub>2</sub> Compatibility Tests			■			

## Develop & Validate LN<sub>2</sub> Cooled Wall Tank

- Purpose: Reduce H<sub>2</sub> flow-through requirements & increase charging rate
- Approach:
  - Build and Test Prototype
  - Compare Results to Full-Scale

## Estimate Storage Systems Cost

- Purpose: Provide comparisons to other systems at 500K units
- Approach:
  - Hexcell and MATI System Cost
  - Progress Ratio for Commercially Available Components
  - DFMA Cost Model for Non-Commercial Items

## Validate Feasibility of BOP Redesign

- Purpose: Develop reduced volume system to meet DOE Targets
- Approach:
  - Structural Analysis
  - H<sub>2</sub> Compatibility of BOP Polymers

# Approach: Chemical Hydrogen Storage

Hydrogen Storage Reports						
Task	FY14		FY15			
	Q3	Q4	Q1	Q2	Q3	Q4
Finalize Chemical Hydrogen Report						
Finalize Cryo-Adsorbent Report						

## Finalize Hydrogen Storage Reports

- Purpose: Document results of work performed 2010-2014
- Approach:
  - Finalize Chemical Hydrogen Storage Report
  - Finalize Cryo-Adsorbent Report

Finalize Chemical Hydrogen Storage Model						
Task	FY14		FY15			
	Q3	Q4	Q1	Q2	Q3	Q4
Finalize Storage Model						
Incorporate into Framework						
Post on the Web						
Accommodate Material Developers						

## Incorporate Chemical Hydrogen Storage Model in Framework

- Purpose: Make model available on the web for material developers
- Approach:
  - Finalize CH Storage Model
  - Incorporate in Framework
  - Accommodate Material Developers

# Development of the LN<sub>2</sub> Cooled Wall Tank

## ► Rationale for Development of LN<sub>2</sub> Cooled Wall Tank

### ■ Problem

- Tank wall difficult to cool with flow-through H<sub>2</sub> cooling
- Estimated 21 kg H<sub>2</sub> for 5.6 kg of fill just to cool wall

### ■ Solution

- Flow LN<sub>2</sub> in an annulus between insulation and tank to cool wall during H<sub>2</sub> filling
- Reduces H<sub>2</sub> required and accelerates the cool-down process

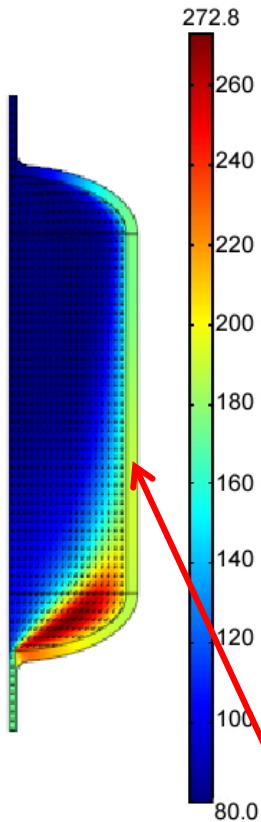

*Note higher wall temperature*

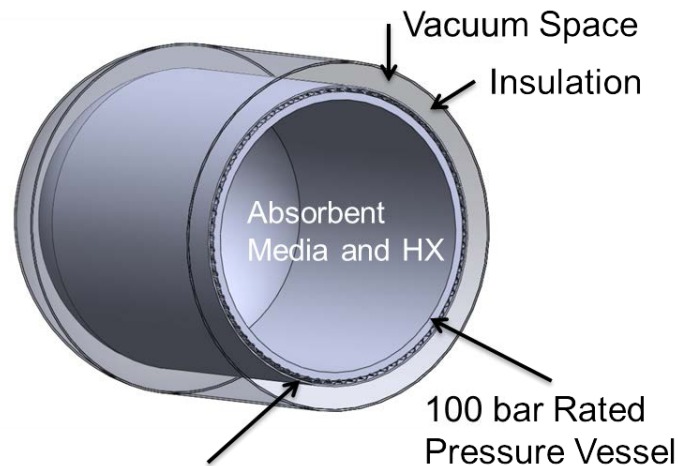

LN<sub>2</sub> Cooling Channels



# LN<sub>2</sub> Cooled Wall Tank Thermal-Mechanical Fatigue Analysis

## Center Milestone (Sept. 2014)

- Evaluate thermal-mechanical stresses considering a fatigue life of 1500 cycles

## Results

- LN<sub>2</sub> cooling is limited by the heat transfer coefficient of the LN<sub>2</sub>.
- Aluminum wall conductance is ~2 orders of magnitude greater than LN<sub>2</sub> heat transfer
- Al-6061-T6 tank can be subject to over 1,000,000 fully reversing stress cycles to initiate a fatigue crack.

**Thermal-mechanical fatigue not a concern for this concept.**

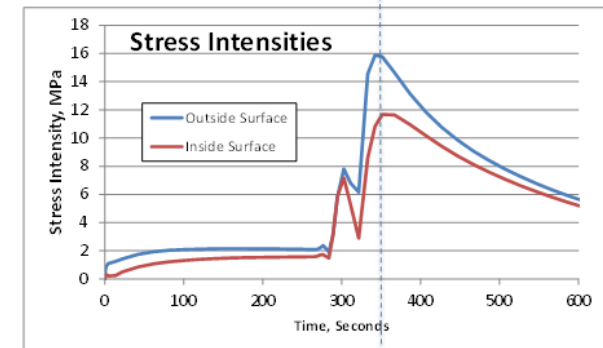
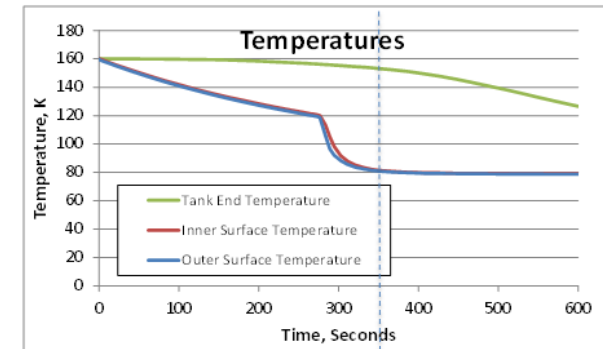
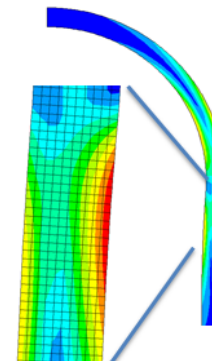
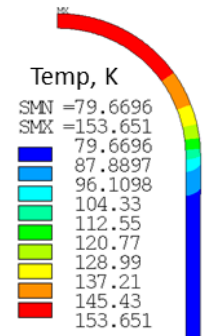
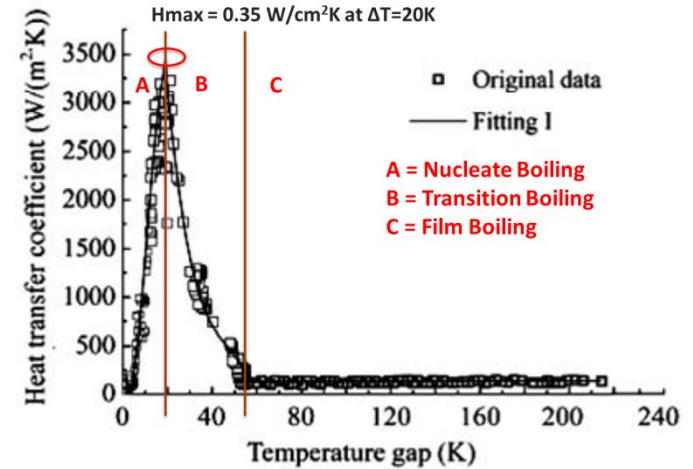

# LN<sub>2</sub> Cooled Wall Tank Prototype Design

- ▶ AOP Milestone (Sept. 2014) (Joint Hexagon-Lincoln/PNNL)
  - Design a 2L prototype tank with the LN<sub>2</sub> cooling that can predict a 3.7 minute fill time for the full-scale system.
- ▶ System Configuration
  - 2L aluminum bottle mounted inside a vacuum insulated dewar must be cooled from 160 to 83K in 50 seconds
  - Variety of hole configurations to study approaches to filling/exhausting
    - Top fill, Bottom fill, Shower spray
    - Tank support cage allows varying gap between tank and dewar

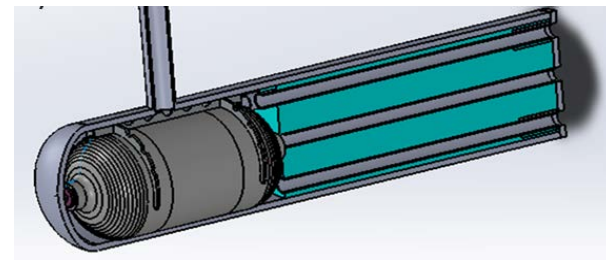
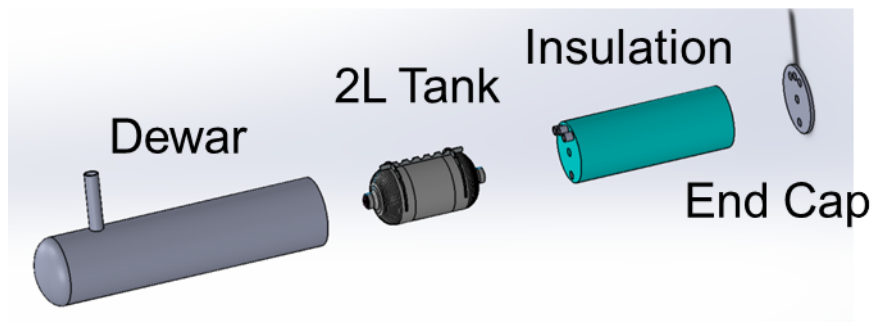



# LN<sub>2</sub> Cooled Wall Tank Prototype Testing Preliminary Results

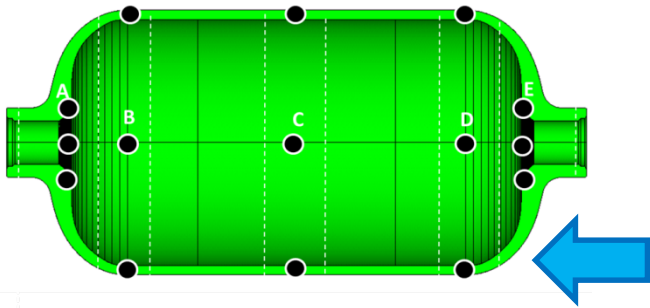

LN<sub>2</sub> Flow  
(Bottom Fill)

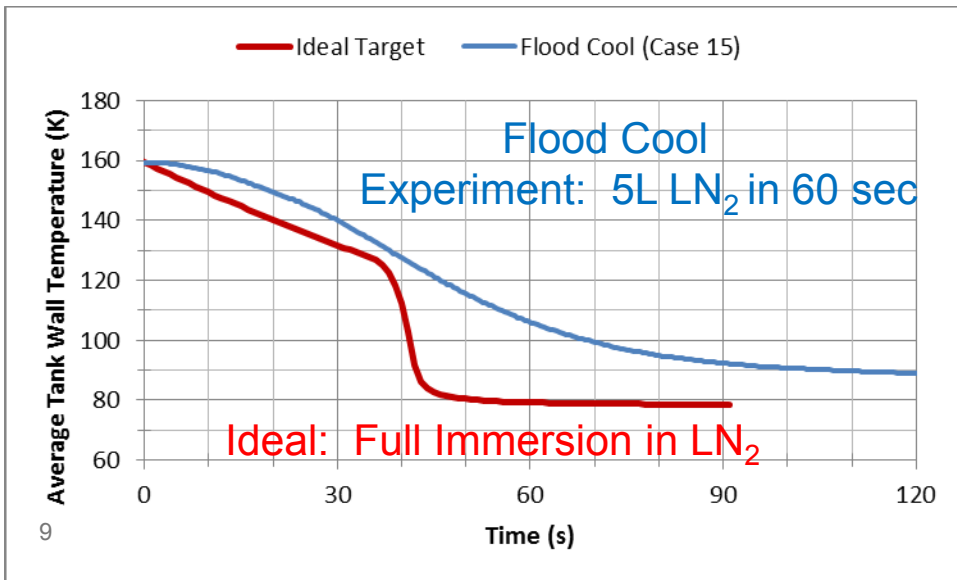
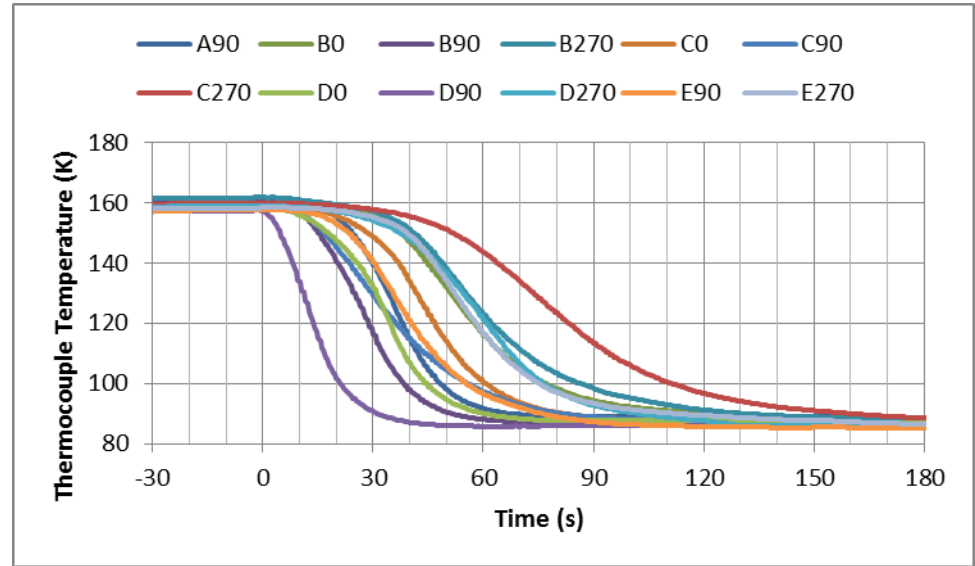

**Pressure Observation:** Pressure build-up not an issue. Higher LN<sub>2</sub> flow rates can be implemented.

**Cooling Observation:** Individual TC's mirror ideal, but average of TC's do not.

**Conclusion:** Broad temperature variation is not ideal. Potential to increase cooling rates by directing LN<sub>2</sub> flow to cover more surface area.

# LN<sub>2</sub> Cooled Wall Tank Prototype Comparison to Full-Scale System

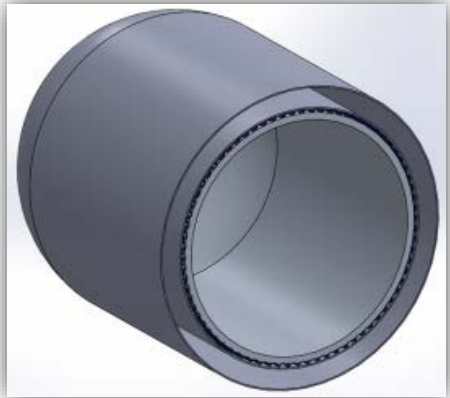

Prototype Cool-Down = 1.5 min

Full Scale Cool-Down Estimate ~ 3 min

### 2L Prototype

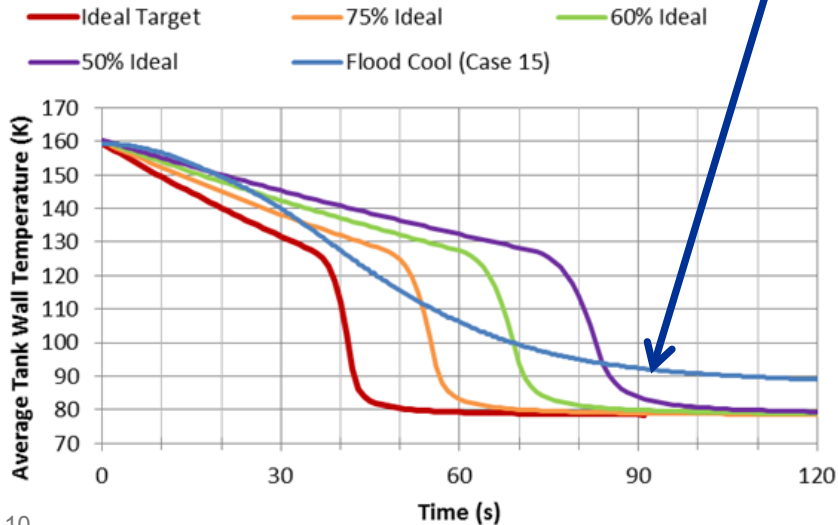

### Full Scale System

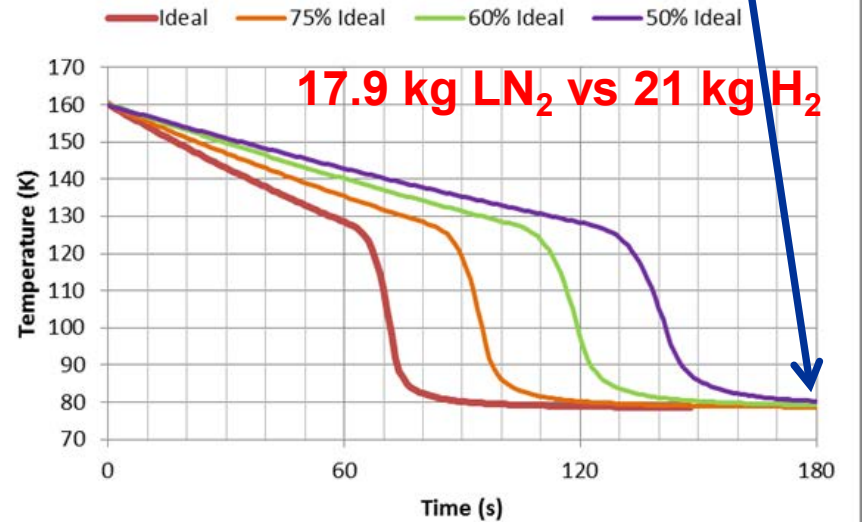

# Cost Modeling Accomplishments

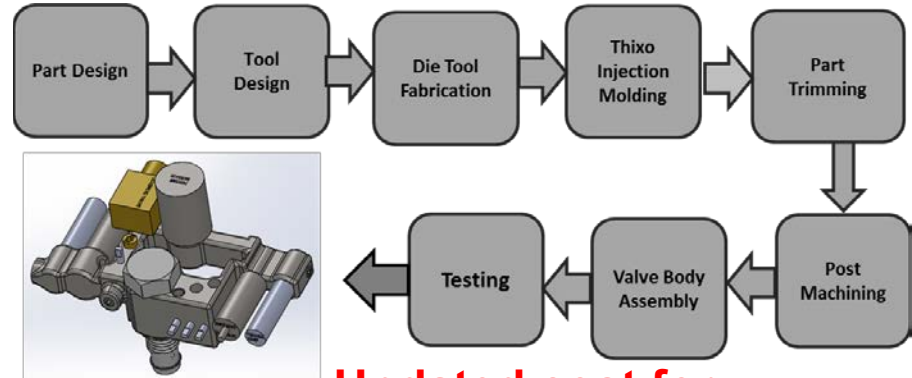
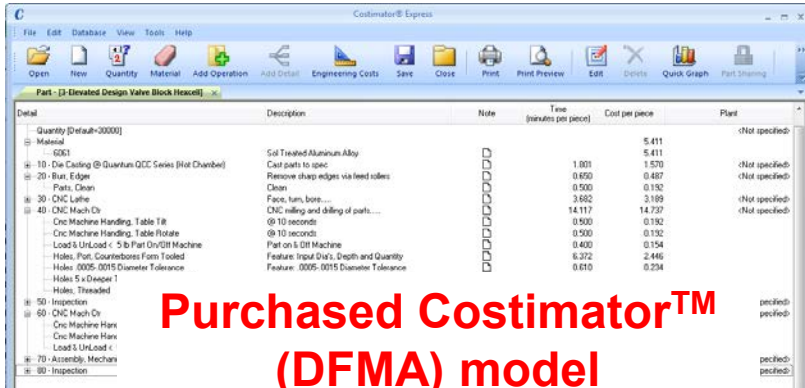

**Updated cost for consolidated valve block**

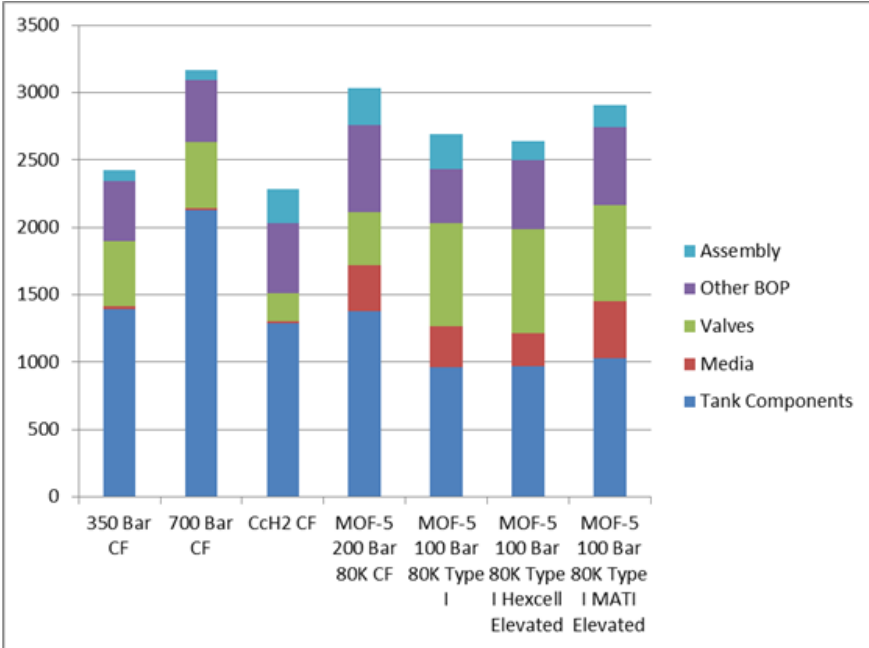

**Updated costs for MATI and Hexcel**

Parameter	HSECOE Value	SA Value
H2 Stored on board (full tank)	6.2kg (5.6kg usable)	6.2kg (5.6kg usable)
H2 Storage Pressure (full tank)	100 bar	100 bar
H2 Storage Temperature (full tank)	80K	80K
MOF-5 Bulk Density	~180kg/m <sup>3</sup>	~180kg/m <sup>3</sup>
MOF-5 Mass per system	32kg	32kg
MOF-5 Cost	\$10/kg	\$10/kg
<b>Internal Vessel</b>		
Internal Water Volume	0.18m <sup>3</sup>	0.19m <sup>3</sup>
Wall Thickness	10mm	10mm
Aluminum Mass	62kg	50kg
Aluminum Cost	\$4/kg	\$5/kg
<b>Outer Shell</b>		
Wall Thickness	2mm	2mm
Aluminum Mass	14.4kg	12kg
Aluminum Cost	\$4/kg	\$5/kg

**Resolved differences between Strategic Analysis and HSECoE**

# Summary of Hexcell Comparison SA to HSECoE

Tank Cost Component	HSECoE Value (500k sys/yr) 2007\$	SA Value (500k sys/yr) 2007\$	BOP Cost Component	HSECoE Value (500k sys/yr) 2007\$	SA Value (500k sys/yr) 2007\$
Inner Tank (Type 1 Al Tank)	\$280	\$334 (Includes Manuf.)	Pressure Regulator	\$258 (\$132 + \$126)	\$218 (2x \$109)
Boss and Plug	\$16	\$4 (boss only)	Filter	\$36	\$5
LN <sub>2</sub> Wall Chiller Channel	\$89	\$120	Temp Sensor	\$21	\$3
Internal Supports	\$23	\$2	Burst Disk	\$7	To be included
Insulation	\$116	\$177	Vacuum Port	\$14	-
Vacuum-Shell/Outer-Shell	\$71	\$139	Pressure Relief Gauges	\$42	\$42 (TPRD) \$20 (PRV)
Getter	\$14	To be included	H <sub>2</sub> Pressure Sensor	\$32	\$20
Honeycomb Al HX	\$60	\$38	Multi-Port Receptacle	\$231	\$80 (2x\$40)
Heater Element	\$17	\$33	H <sub>2</sub> Cond HX	\$203	\$66
MOF -5	\$320	\$320	Tubing	\$42	\$16
Tank Assembly	\$283 (manufacturing)	\$243 (assembly plus 10% cost contingency)	Valves and Fittings	\$341	\$528
<b>Total Tank Costs</b>	<b>\$1,289</b> (does not include \$19 for H <sub>2</sub> )	<b>\$1,408</b>	Fuel Tank Controller	\$8	\$80
			BOP Assembly	\$146	\$94
			<b>Total BOP Cost</b>	<b>\$1,430</b>	<b>\$1,172</b>
			<b>Total System Cost</b>	<b>\$2,720</b>	<b>\$2,580</b>

# Summary of MATI Comparison SA to HSECoE

Tank Cost Component	HSECoE Value (500k sys/yr) 2007\$	SA Value (500k sys/yr) 2007\$	BOP Cost Component	HSECoE Value (500k sys/yr) 2007\$	SA Value (500k sys/yr) 2007\$
Aluminum Tank	\$224	\$249	Heat Exchanger	\$203	\$66
LN2 Channel	\$73	\$112	FC Coolant Bypass Valve	\$41	\$20 (T-fitting)
Insulation	\$132	\$223	Hydrogen Fittings	\$251	\$317
Outer/Vacuum Shell	\$61	\$116	Multi-port Receptacle	\$115	\$80 (2x\$40)
MATI	\$235	\$225	Components on Elevated Design	\$390	\$200
MOF	\$410	\$410	Pressure Regulator	\$126	\$218 (2x \$109)
Tank Manufacturing/ Assembly	\$253	\$217	Controller	\$6	\$80
Heated Line	-	\$121	Other	\$163	\$33
Other	\$53	\$26	BOP Assembly	\$159	\$92
<b>Total Tank Costs</b>	<b>\$1,441</b>	<b>\$1,697</b>	<b>Total BOP Cost</b>	<b>\$1,456</b>	<b>\$1,132</b>
			<b>Total System Cost</b>	<b>\$2,897</b>	<b>\$2,830</b>

- SA/HSECoE performed independent cost analyses
- Reconciled differences resulting in improved estimates for both organizations

# Consolidated Valve Block

Looking for approaches to reduce part count and system cost, mass and volume

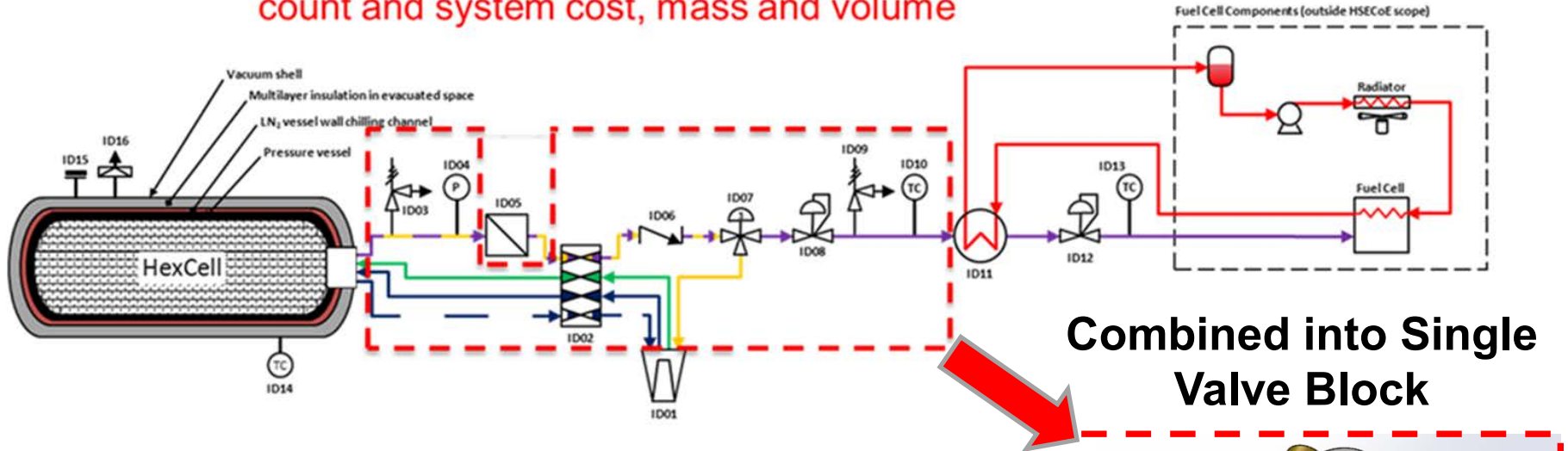

**Combined into Single Valve Block**

## ► Results

- Reduction in Mass 9.4 kg → 5.1 kg
- Reduction in Volume 11.6 L → 0.75 L
- Reduce number of fittings from 49 to 18
- Cost improvement from \$534 to \$196 or about \$338 savings

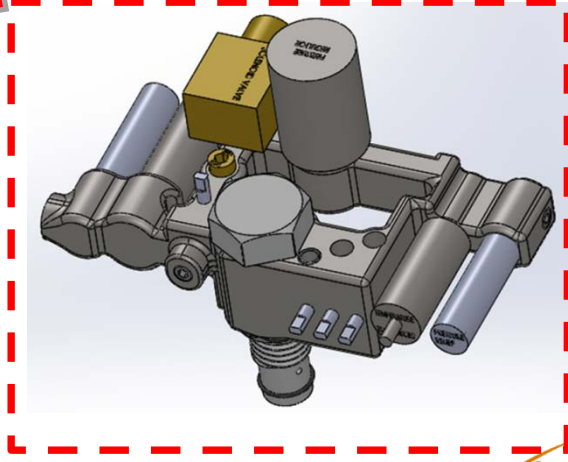

# Structural and Thermal Analysis of Valve Block

## Pressure

- ▶ Aluminum-6061
- ▶  $P = 100$  bar
- ▶ Stress Ratio = 4 (NGV3/CSA)
- ▶ Based on maximum diameter to thickness ratio for part
- ▶ Demand/Capacity = 0.77

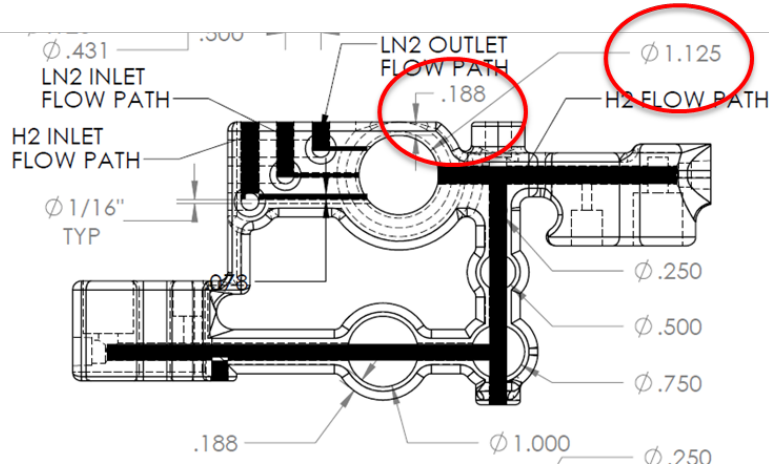

**No structural issues as a result of pressure**

# Structural and Thermal Analysis of Valve Block

## Pressure

- ▶ Aluminum-6061
- ▶ P = 100 bar
- ▶ Stress Ratio = 4 (NGV3/CSA)
- ▶ Based on maximum diameter to thickness ratio for part
- ▶ Demand/Capacity = 0.77

## Thermal

- ▶ LN<sub>2</sub> Surface Heat Transfer Coefficients

Source	P (atm)	ΔT (K)	H (W/cm <sup>2</sup> /K)
Experimental (Lin et al 2009)	1	20	<b>0.35</b>
Predicted	1	80	<b>0.02</b>
Predicted	20	1	<b>1</b>

- ▶ Aluminum Conductivity

- Part Distances ~ 1cm
- $k = 1.67\text{W/cmK}/1\text{cm} = \mathbf{1.67\text{W/cm}^2\text{K}}$

- ▶ Conclusions:

- Aluminum Conductivity > LN<sub>2</sub> heat transfer coefficient
- Heat transfer faster through aluminum than LN<sub>2</sub> removes heat from the surface
- Thermal gradient through the aluminum will be small
- Thermal stresses will also be small

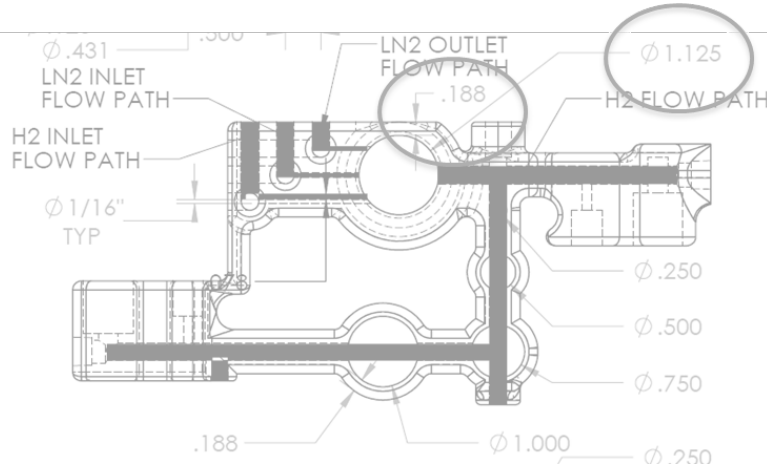

**No thermal issues with this valve block**



# Polymer Compatibility

- ▶ AOP Milestone (Dec. 2014)
  - Evaluate material compatibility for consolidated valve block materials for cryo-adsorbent systems

Use	Material	Check valves	Control valves	Tanks and Pipes
Seals	PTFE	x	x	
	PEEK	x		
Pistons	PEEK	x	x	
Seats	PCTFE		x	
	ECTFE		x	
Tanks /pipes	HDPE			x

# Polymer Compatibility

Use	Material	Check valves	Control valves	Tanks and Pipes
Seals	PTFE	x	x	
	PEEK	x		
Pistons	PEEK	x	x	
Seats	PCTFE		x	
	ECTFE		x	
Containment/ pipes	HDPE			x

► AOP Milestone (Dec. 2014)

- Evaluate material compatibility for consolidated valve block materials for cryo-adsorbent systems

► Approach

- 340 bar H<sub>2</sub> soak followed by compression testing in LN<sub>2</sub>

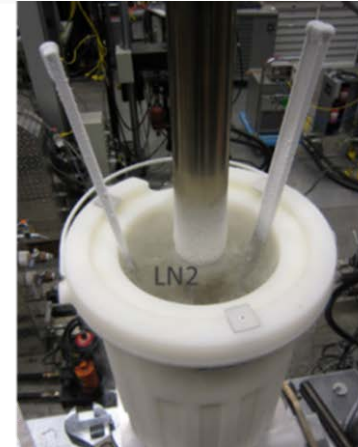
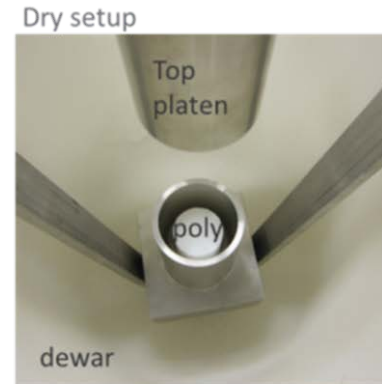
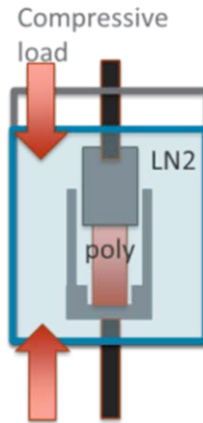

# Polymer Compatibility

## ► AOP Milestone (Dec. 2014)

- Evaluate material compatibility for consolidated valve block materials for cryo-adsorbent systems

## ► Approach

- 340 bar H<sub>2</sub> soak followed by LN<sub>2</sub> compression testing

## ► Results

- Compressive modulus increases while yield stress decreases for PTFE and ECTFE

Use	Material	Check valves	Control valves	Tanks and Pipes
Seals	PTFE	x	x	
	PEEK	x		
Pistons	PEEK	x	x	
Seats	PCTFE		x	
	ECTFE		x	
Containment/pipes	HDPE			x

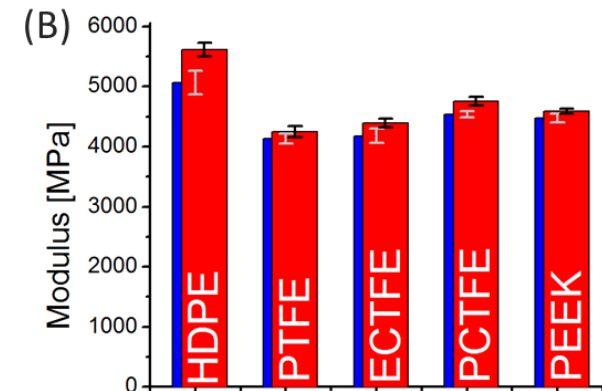
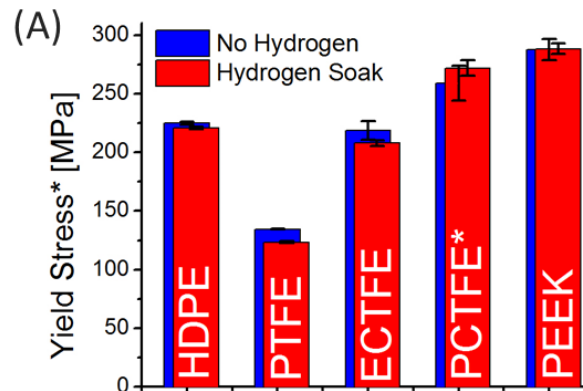
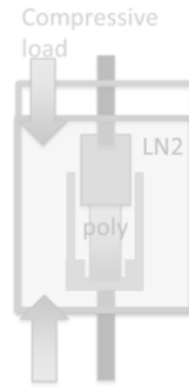

# Polymer Compatibility

Use	Material	Check valves	Control valves	Tanks and Pipes
Seals	PTFE	x	x	
	PEEK	x		
Pistons	PEEK	x	x	
Seats	PCTFE		x	
	ECTFE		x	
Containment/pipes	HDPE			x

► AOP Milestone (Dec. 2014)

- Evaluate material compatibility for consolidated valve block materials for cryo-adsorbent systems

► Approach

- 340 bar H<sub>2</sub> soak followed by LN<sub>2</sub> compression testing

► Results

- Compressive modulus increases while yield stress decreases for PTFE and ECTFE

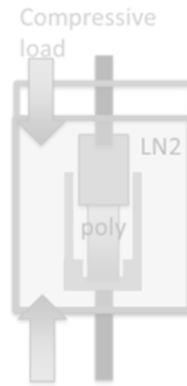

H<sub>2</sub> result in modest changes in yield and modulus

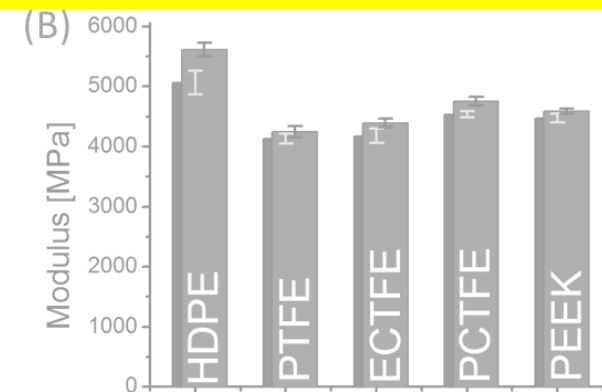
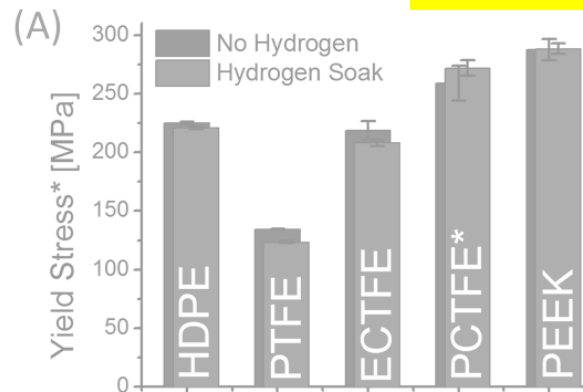

# Chemical Hydrogen Storage Model on the Web

## ► Center Milestone:

- Update the chemical system model, integrate into the framework; document and release models to the public.

## ► Results:

- Endothermic (AB) and Exothermic (alane) models posted at [www.hsecoe.org](http://www.hsecoe.org) in Jan 2015
- Developing a preprocessor to convert kinetic and thermodynamic data from material developers into input parameters into the model

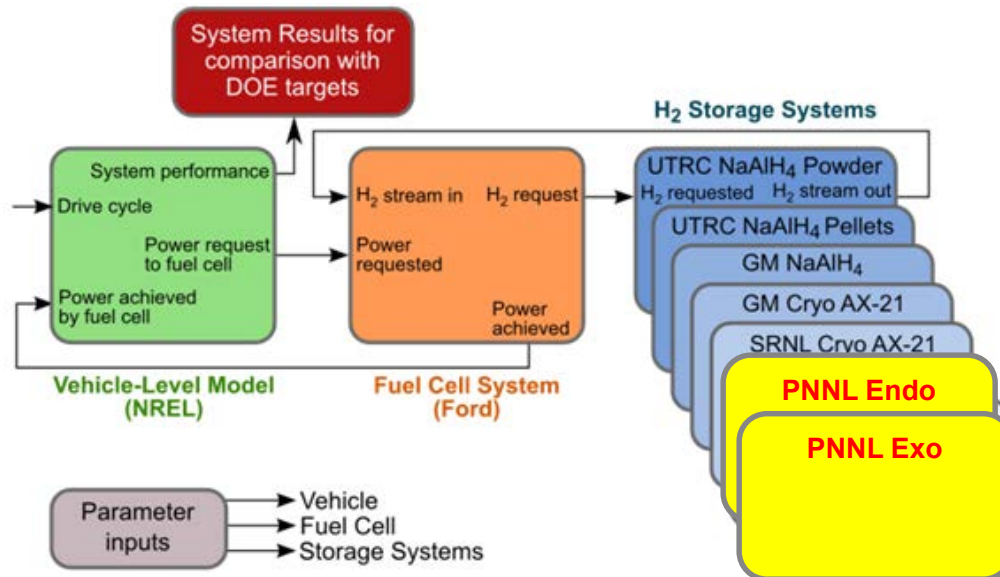

# Response to Previous Year Reviewer's Comments

- ▶ Comment: The general amount of cryogenics consumed seems to be high. The cost implications of using that much cryogen should be determined.  
Response: The full scale prototype system is expected to require 17.9 kg of LN<sub>2</sub> to lower the temperature of the aluminum tank and the inner vacuum jacket liner from 160K to 80K. Assuming H<sub>2</sub> is four times the price of LN<sub>2</sub>, similar cooling with H<sub>2</sub> requiring 21 kg would be 4.7x more expensive.
- ▶ Comment: There has been good coordination within the HSECoE, but there is little evidence of collaboration outside of it.  
Response: The project has been coordinating with Strategic Analysis, a non-HSECoE partner, to compare system cost estimates for the cryo-adsorbent systems. By working independently and then comparing the results, we have identified several gaps and inconsistencies, providing an overall better product.
- ▶ Comment: Reduction of BOP mass and volume is an interesting conceptual exercise and probably worth doing. However, it is important to note that the BOP mass savings achieved is minor compared to the mass of the overall storage system. Thus, resources are being spent on a small part of the weight problem, not the main one.  
Response: The development of the consolidated valve block does result in only modest reductions to the overall mass and volume of the system, but its more significant contribution is the reduction in cost by eliminating the number of fittings required.
- ▶ Comment: Feasible hydrogen storage materials are not available for more practical simulations/modeling. The team is asked to perform simulations on materials and concepts that will not be of practical use.  
Response: The hydrogen storage models are being developed so that they can be more easily used by material researchers as they develop new, innovative materials that may be capable of meeting the targets.

# Collaborative Activities

## Hydrogen Storage Engineering Center of Excellence

- Hexagon Lincoln – fabricated and performed LN2 cooled wall tank testing, continued development of pressure vessels
- UTRC - framework model lead
- LANL - CH system architect
- NREL – Assist in the development, testing, and publishing of the system model
- Ford – characterization of absorbent materials
- UQTR – Phase 3 Hexcell testing
- OSU – MATI design and fabrication
- SRNL – Phase 3 MATI adsorbent testing and modeling

## SSAWG

- ANL—developing material requirements for hydrogen storage materials
- Participate in group discussions and analysis

## Materials ‘Reactivity’ Program

- Khalil (UTRC) and Anton (SRNL) - understand reactivity properties of AB
- Van Hassel (UTRC) - study impurities in H<sub>2</sub>

## Independent Analysis

- SA - provide design details for Hexcell and MATI systems and share cost parameters for system cost modeling

# Remaining Challenges and Barriers

- ▶ Finding hydrogen storage materials that meet all the DOE Technical Targets
  - Need CH storage materials that meet the hydrogen storage capacity, stability, kinetics and the on-board and well-to-wheels efficiency. Liquid materials would be preferred.
  - Need Cryo-adsorbent materials with high volumetric capacity that can be operated closer to ambient temperature
- ▶ Additional materials research is required. As a result, HSECoE needs to:
  - Provide support for material researchers in using the hydrogen storage system models on the web to better direct their research
  - Get the lessons learned and knowledge generated during the center into the hands of future system developers as new materials are available to not require “reinventing the wheel”



# Proposed Future Work

- ▶ Project completion September 2015
- ▶ Cryo-Adsorbents
  - LN<sub>2</sub> Cooled Wall Tank Prototype
    - Complete analysis and scale results to full scale system
  - Finalize PNNL Contribution Report
    - Includes cost modeling, BOP development, and LN<sub>2</sub> cooled wall tank results
- ▶ Chemical Hydrogen Storage
  - Improve model to make it more user-friendly for future material developers
  - Support material developers in using framework
- ▶ Both Systems
  - Document results of the center work in final reports and journal articles

# Technology Transfer Activities

- ▶ HSECoE is working with Industrial Collaborators (e.g. Ford, GM)
  - They have access to any IP that is developed
- ▶ Chemical Hydrogen Storage Materials
  - Posted models on the web to allow use by the general public
  - Working with Cella Energy to develop systems using chemical hydrogen storage materials
    - Based on the results developed in the HSECoE
  - Received a patent on chemical hydrogen storage system design
    - Brooks, Kriston P., Jamie Holladay, Kevin Simmons, “Combined on-board hydride slurry storage and reactor system and process for hydrogen-powered vehicles and devices,” Patent # 8,889,097, 11/18/2014.
- ▶ Cryo-Adsorbent Materials
  - Posted “Tankinator” tank design and costing model on the web (2014)
  - Patent applied for on cryo-adsorbent cooling
    - Newhouse, Norm, John Makinson, and Kevin Simmons, “Thermal Insulation Shell System For Composite Pressure Vessel,” U.S. Provisional Patent Application No. 61/822,580, May 2013.

# Project Summary

<b>Relevance</b>	Address the engineering challenges for materials based hydrogen storage and provide materials researchers with models and materials requirements to assess their material's performance in an automotive application.
<b>Approach</b>	<ul style="list-style-type: none"><li>• Design systems/validate the components in these systems</li><li>• Develop system models/experimentally validate them.</li><li>• Determine cost estimates of the system and material properties to guide future selections.</li></ul>
<b>Technical Accomplishments and Progress</b>	<ul style="list-style-type: none"><li>• Designed, fabricated and tested LN<sub>2</sub> cooled wall tank prototype. Structurally &amp; thermally analyzed full scale system.</li><li>• With assistance from OEMs and SA, improved cost models.</li><li>• Developed approach to saturating polymers with H<sub>2</sub> and evaluating their properties at cryogenic temperatures.</li><li>• Posted CH storage model with vehicle framework on web.</li></ul>
<b>Collaborations</b>	<ul style="list-style-type: none"><li>• Extensive collaboration with all of our HSECoE partners</li></ul>
<b>Proposed Future Research</b>	<ul style="list-style-type: none"><li>• Analyze &amp; scale results from LN<sub>2</sub> cooled wall tank prototype</li><li>• Finalize center reports and journal articles to share results with materials researchers and future system developers.</li></ul>

Project ID# ST005

**Kriston Brooks**

(509) 372-4343

kriston.brooks@pnnl.gov



Pacific Northwest  
NATIONAL LABORATORY

# Technical Back-up Slides

# Approach to Developing Cost Estimate

- ▶ Obtain schema from system architect
- ▶ Develop a bill of materials from the schema
- ▶ Develop O&M, energy costs and labor estimates
  - O&M costs based on literature review, manufacturer's estimates and team member feedback
  - Labor estimates based on team member estimates, and/or estimates from the literature
- ▶ Prices obtained for raw materials from manufacturers to the extent possible
  - Significant component prices agreed by SA and HSECoE
- ▶ Balance of plant costs developed based on manufacturer price estimates, literature review or cost estimates from cost models
  - Typically prices from distributors, adjusted to manufacturer's price based on the literature