

Advancement of Systems Designs and Key Engineering Technologies for Materials Based Hydrogen Storage

Bart A. van Hassel, J.M. Pasini, and J.R. Karra

United Technologies Research Center
411 Silver Lane, East Hartford, CT

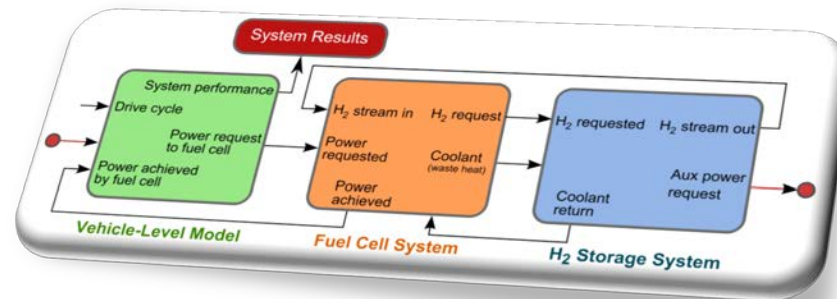

Annual Merit Review

Arlington, VA

June 8-12, 2015

Project ID: ST006

Overview

■ Timeline

- Project Start Date: 2/1/09
- Project End Date: 6/30/15

■ Budget

- Total Project Value: \$5.46
- Cost Share: \$1.15 M
- DOE Share: \$4.24M
- Total Funding Spent*: \$4.31M

■ Barriers*

- A – J
- A. System Weight & Volume
- D. Durability/Operability
- J. Thermal Management

■ Targets**

- All

■ Partners



* As of 3/31/15

** DOE EERE FCTO Program Multi-year Plan for Storage



Objectives

- Design of materials based vehicular hydrogen storage systems that will allow for fast refueling and a driving range of greater than 300 miles

Performance Measure	Units	2020	Ultimate
System Gravimetric Capacity	g H ₂ /kg system	55	75
System Volumetric Capacity	g H ₂ /L system	40	70
System fill time (for 5 kg H ₂)	minutes	3.3	2.5
Fuel Purity	% H ₂	SAE J2719 guideline (99.97% dry basis)	

- Major project impact:
 - Integrated Power Plant Storage System Modeling (IPPSSM):
 - Compared H₂ storage systems on a common basis
 - Supported storage system model integration
 - Developed GUI for models on the web (at: www.hsecoc.org)
 - H₂ Quality: Particulate filter right-sizing
 - Published results in high-impact journals

Phase 3 S*M*A*R*T Milestones and Status

S*M*A*R*T Milestone	Status
Update the cryo-adsorbent system model with Phase 3 performance data, integrate into the framework; document and release models to the public.	<p>✓ Initial adsorption based H₂ storage system (5.6 kg H₂ delivered) implemented in Framework. Developed user guides.</p>
Report on the ability to filter particulates in gas from a cryo-adsorbent bed to less than 1000 µg/m ³ and 10µm diameter (SAE J2719 guideline).	<p>✓ 0.01 µg/m³ (i.e. <<1000 µg/m³) (meets target) Some >10µm particles (0.01 µg/m³): Stringent system cleanliness procedures.</p>

Hydrogen Vehicle Simulation Framework

Select storage system: Center logo

Running scenario: Test case: 1 Fuel economy test (UDDS...)

Storage system variables - Single run

Auxiliary loads	kW	(0.2 - 2)	0.7	Inert weight	-	(0 - 0.4)	0.1
Combustor	-	(0.5 - 1)	0.9	Refueling fraction	-	(0.5 - 1)	0.85
Extra volume	L	(0 - 200)	0	Refueling pressure	bar	(60 - 110)	100
Hydr. crystal	kg/m	(500 - 851.4)	851.4	Refueling	C	(-20 - 50)	39.7
Hydr. weight	-	(0.01 - 0.11)					
Hydride mass	kg	(1 - 400)	65				
Hydride void	-	(0.2 - 0.6)	0.3				

Inputs with range checking

Run simulation

Results:

- H₂ delivered: 5.76 kg
- H₂ used: 5.76 kg
- Usable H₂: 5.63 kg
- Storage system mass: 97.8 kg
- Storage system volume: 136.5 L
- Gravimetric capacity: 5.8 %
- Volumetric capacity: 41.3 g/L
- On-board efficiency: 97.8 %
- Temperature: 70.6 C

Pressure: 3 bar
Raw distance: 415 miles
Calculated fuel economy: 48 mpg
Calculated range: 415 miles

Vehicle speed [mph] vs time [s] plot (Zoomable plots)

Stop simulation | Save results | Generate all plots

Generate Matlab® plots



Callouts: User-specified precision, Show results only for relevant test cases, Save scalar and time-dependent results into Excel-compatible files



Approach

- Simulink® Framework:
 - Develop graphical user interface (GUI) architecture and perform beta-tests
 - Implement usability features targeted towards hydrogen storage material development community and decision makers
 - Make Simulink® Framework publically available
 - Web-version available on website hosted by NREL: : www.hsecoe.org
 - Support integration of other H₂ storage models in framework
 - ✓ Physical storage (compressed gas)
 - ✓ Metal hydride
 - ✓ Chemical hydrogen storage
 - Adsorbent (in progress)
- H₂ quality:
 - Right sizing of particulate filters for MOF-5

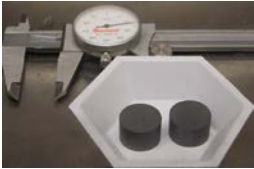
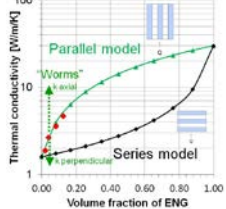
Use results to estimate material property requirement for DOE's 2020 system level targets.

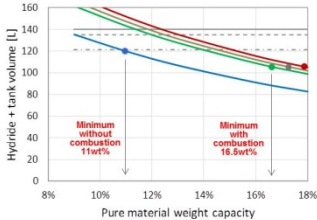
Approach

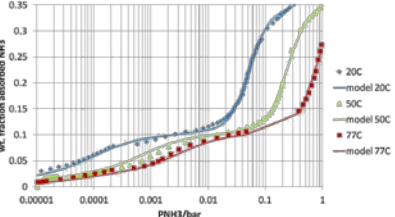
	2009	2010	2011	2012	2013	2014	2015	
Metal Hydride	<p>Compaction</p> 	<p>Thermal Conductivity Enhancement</p> 	<p>Material Requirements</p> 					

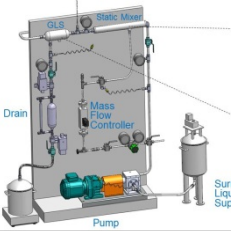
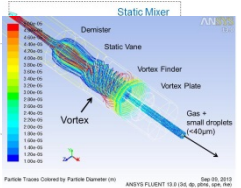
Chemical Hydrogen Storage	<p>H₂ Quality</p> 	<p>Solid Transport</p> 	<p>Gas/Liquid Separation</p> 	<p>Material Requirements</p> 
----------------------------------	---	--	---	---

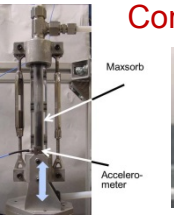
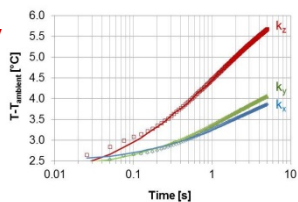
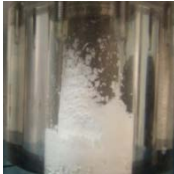
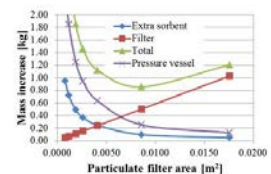
Adsorption	<p>Compaction</p> 	<p>Thermal Conductivity Anisotropy:</p> 	<p>H₂ Quality</p> 	<p>Right-Sizing</p> 
-------------------	---	--	--	---

Simulink® Framework

Blank Sheet

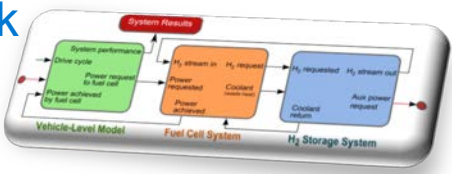

2011: Metal Hydride System

Graphical User Interface development

2013-2015: Other System Integration

HSECoE Hydrogen Vehicle Simulation Framework

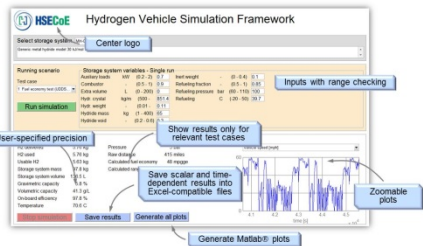

Models on the web:
www.hsecoe.org

Collaborations



H₂ storage system models:

- Comparison of H₂ storage systems on a common basis
- Integration of storage system models in framework
- Graphical user interface development for Simulink® framework and beta-test with ORNL, SNL and ANL



Cryo-adsorption:

- Particulate mitigation
- Sharing best practices



Task 32: Hydrogen-based energy storage
H₂ Storage for Mobile Applications: Niche Application Opportunities

MODELS ON THE WEB

PLEASE VISIT: WWW.HSECOE.ORG

Framework with Graphical User Interface (GUI)

Framework/GUI published on the HSECoE website

- Six systems published on the HSECoE website: <http://www.hsecoe.org/>
 - Test system: for isolated running of fuel cell and vehicle.
 - Compressed: 350 bar, 700 bar
 - Ideal metal hydride system
 - Ammonia Borane slurry (exothermic)
 - Alane slurry (endothermic)
- Speed trace miss computation aligned with EPA methodology

Updated GUI based on feedback from Tech. Team and beta testers.

- Improved Excel-compatible output – compressed output for long runs
- Added diagrams for overall framework and selected systems
- Defined an interface for sizing systems – need to implement

Models on The Web: Location & Overview

- Center website: <http://hsecoe.org/>
- Model support: HSECoE@nrel.gov

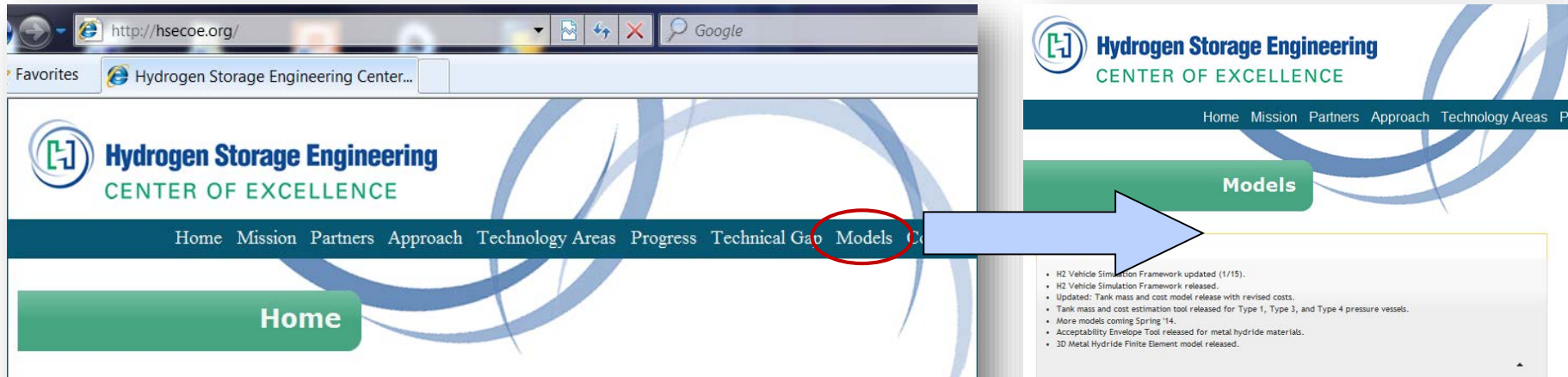

Model	Platform	Description
MHAE	Excel	Metal Hydride Acceptability Envelope: Tank internal HX sizing based on steady-state thermal model during refueling
MHFE-SAH	Comsol® 4.2a	Finite Element Sodium Aluminum Hydride Model: 3D model of SAH bed with shell-and-tube, finned HX based on UTRC prototype.
Vehicle Framework	Matlab/Simulink® 2011b or newer	Hydrogen Vehicle Simulation Framework: Dynamic model of Fuel Cell light-duty vehicle. 4 hydrogen discharge scenarios
Tankinator	Excel	Tank Mass & Cost Estimation Model

GUI Update: Framework and System Diagrams

Making Simulink® framework more user-friendly for material developers

- Based on feedback from beta testers, we have added framework and system diagrams

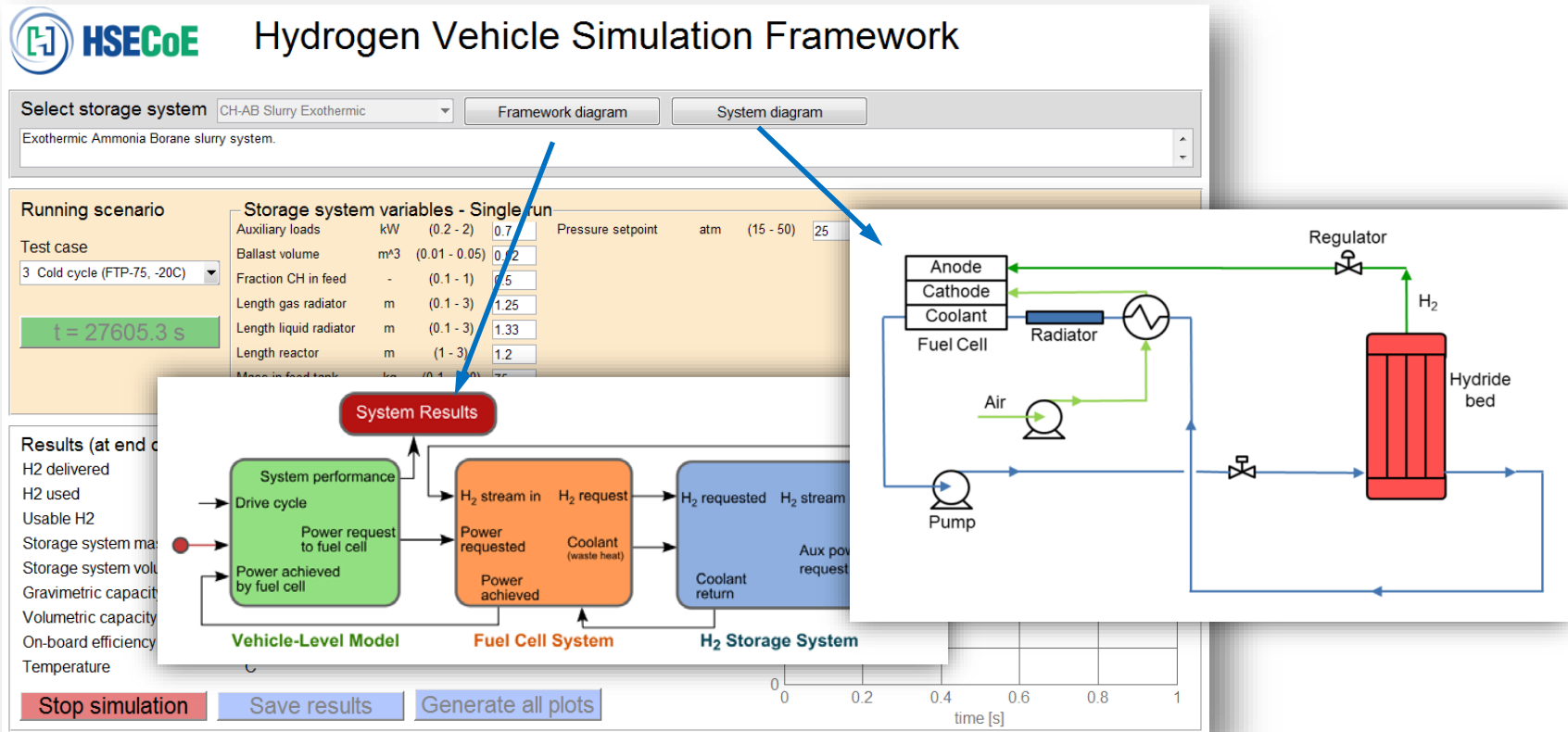

Overall Performance Checks

Speed trace miss computation aligned with EPA methodology

- Power failure due to storage system
 - Fuel cell can deliver power, but H₂ flow rate is not enough: empty tank or slow kinetics
- Speed trace miss due to undersized vehicle components (fuel cell, power train)
 - Aligned with standard speed trace miss criteria: ± 2 mph in a ± 1 s window.
 - Check performed as post-process:
A speed trace miss does not stop the simulation

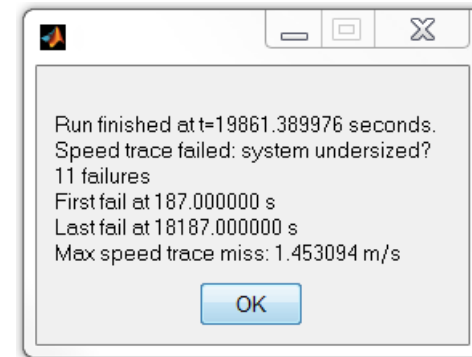
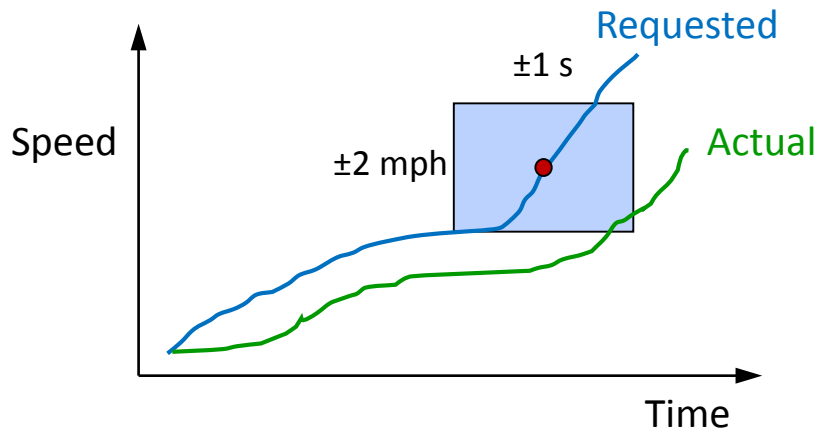

Sample error message if speed trace miss detected

Connection to Other Tools

Output in user-friendly format

Generate Matlab® plots for further editing

Save results into Excel-compatible text files

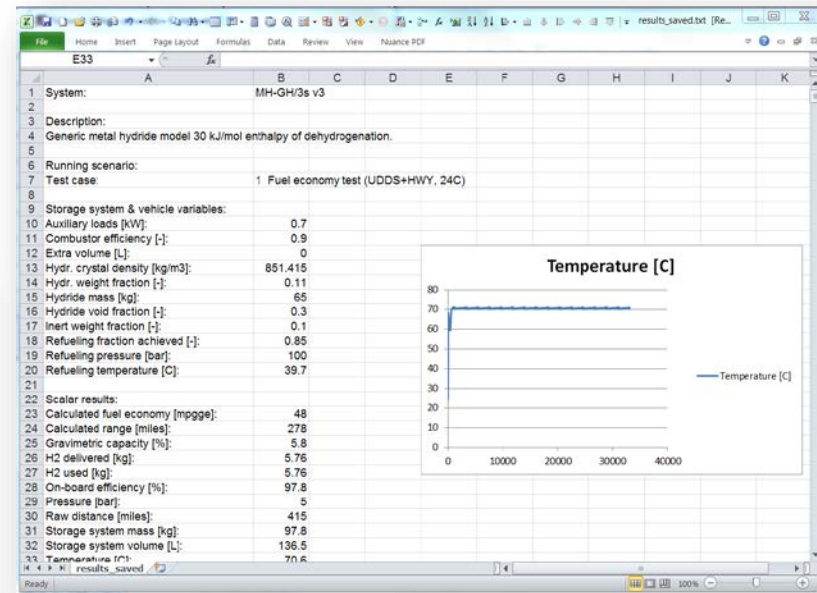
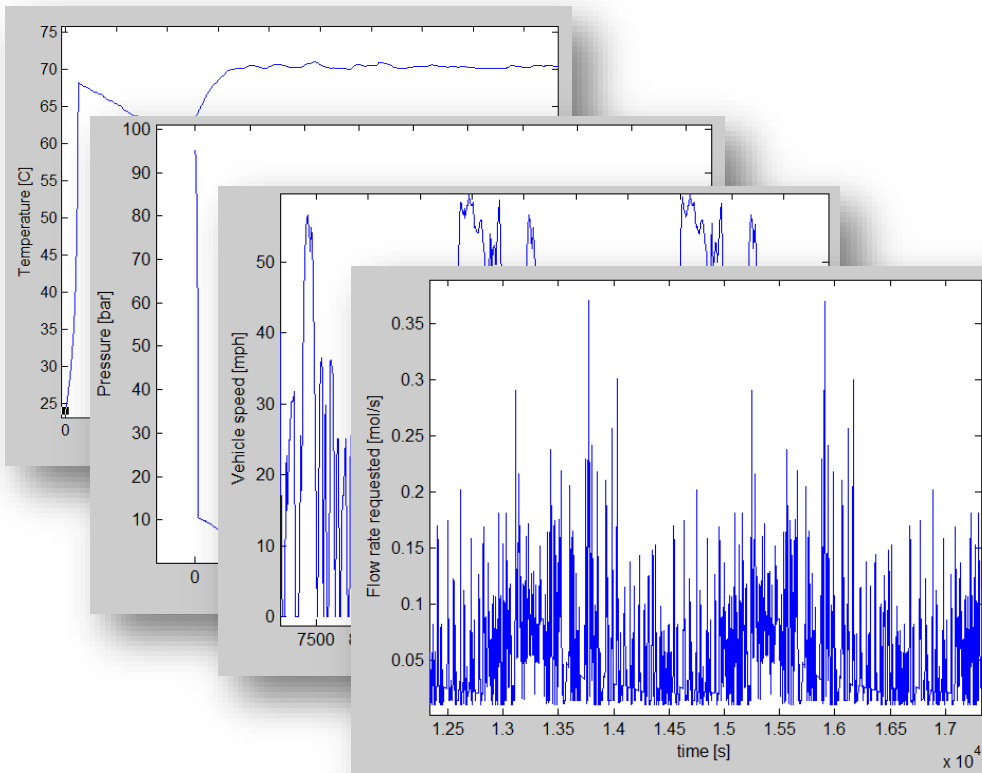

Design Space

There is an opportunity for systems with a range of performance metrics

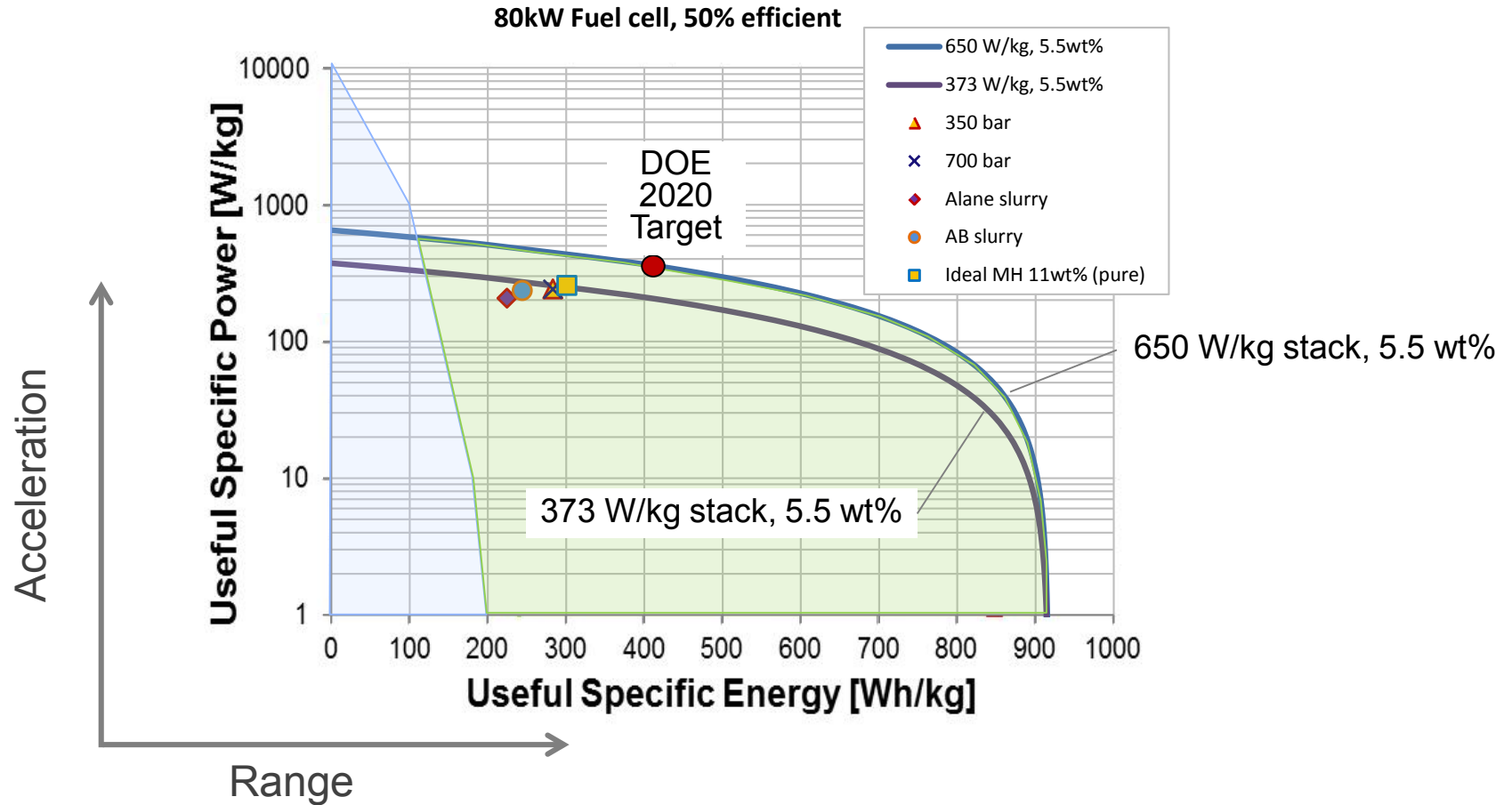

- The framework includes a more conservative Fuel Cell System design (80kW, 214kg → 373 W/kg)

H₂ QUALITY

H₂ Quality Guidelines (SAE J2719)

Porous metal media filters enable efficient adsorbent particulate filtration.

Contaminant	ppm		
Water	5	Particulate size	<10 μ m
Total hydrocarbons (C1 basis)	2	Particulates	<1 μ g/L
Oxygen	5		
Helium	300	Missing	
Inert gases (N ₂ , Ar)	100	Diborane	
Carbon dioxide	2	Borazine	
Carbon monoxide	0.2	Siloxanes	
Sulfur compounds	0.004		
Formaldehyde	0.01		
Formic acid	0.2		
Ammonia	0.1		
Total halogenates	0.05		
Total gases *	300		
Hydrogen fuel index (minimum, %)	>99.97		

Phase 3

Experimental Setup:

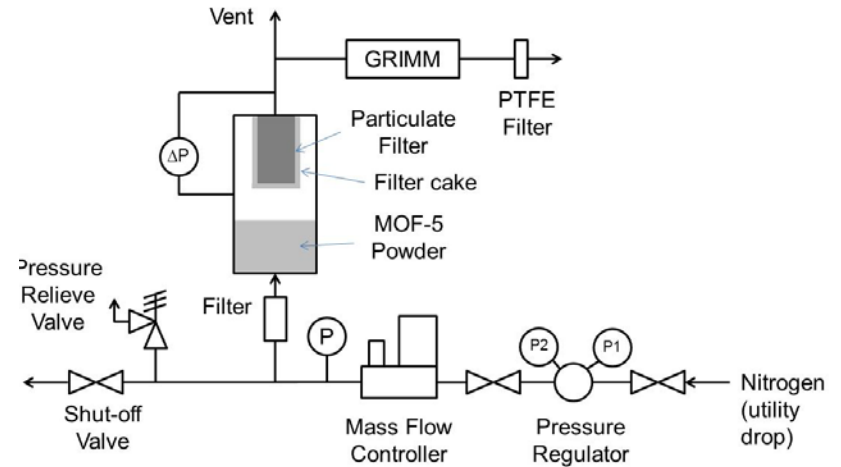

MOF-5 Particle Size Distribution:

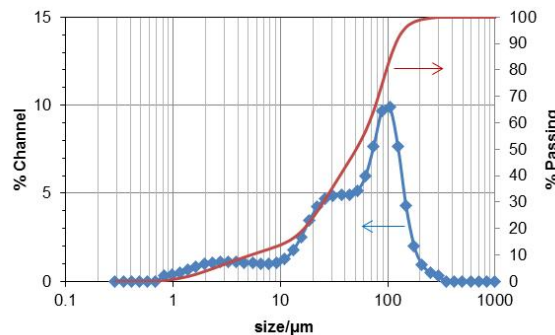

Particulate Concentration:

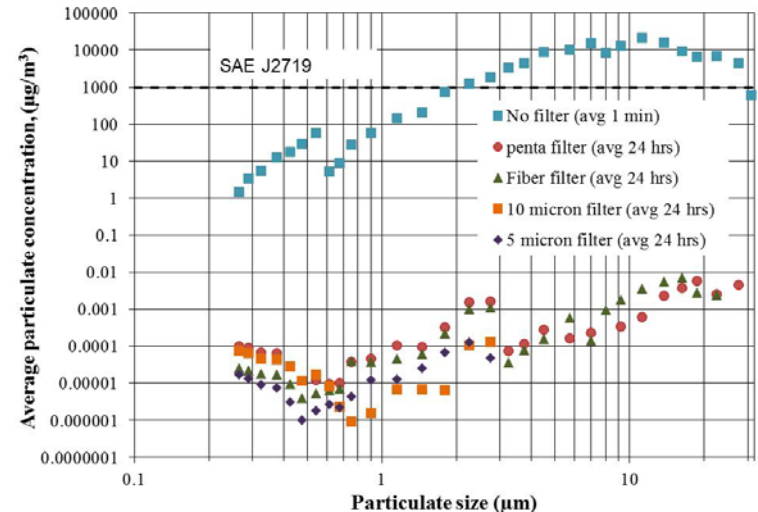

Particulate Filter Area Right-Sizing

Pressure drop through particulate filter affects H₂ adsorption.

- Particulate Filter Configurations

- Impact of pressure drop

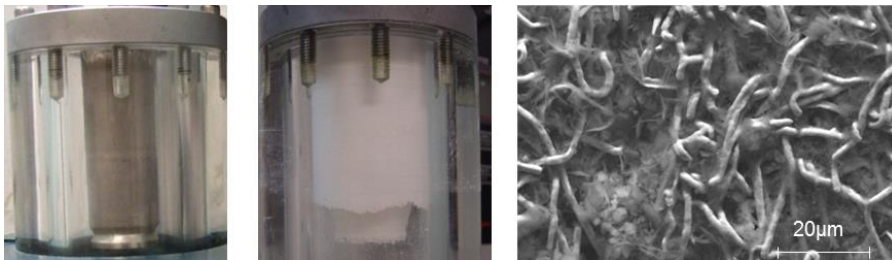
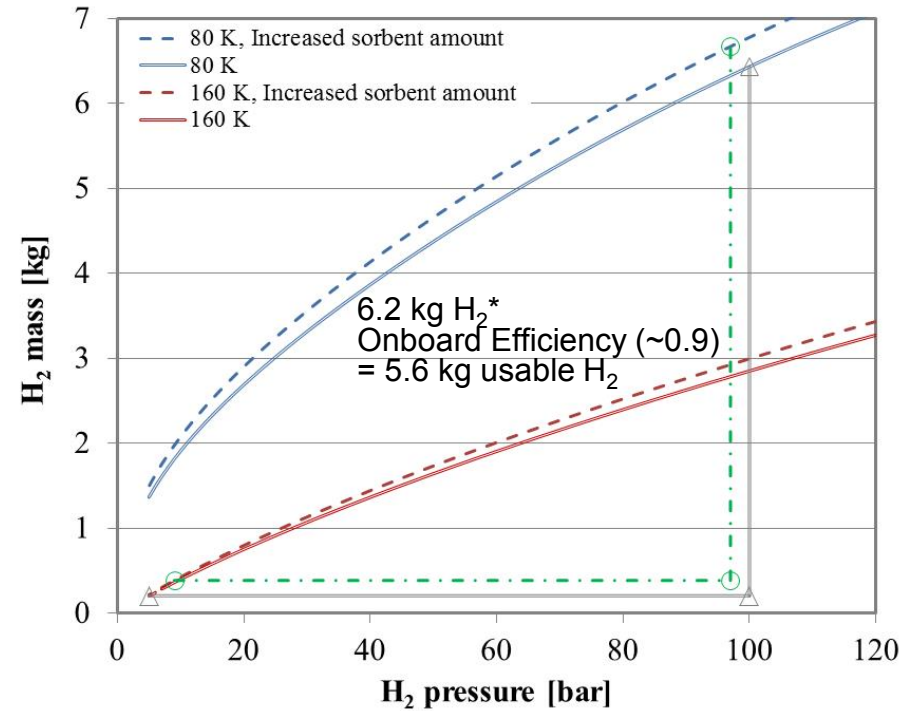
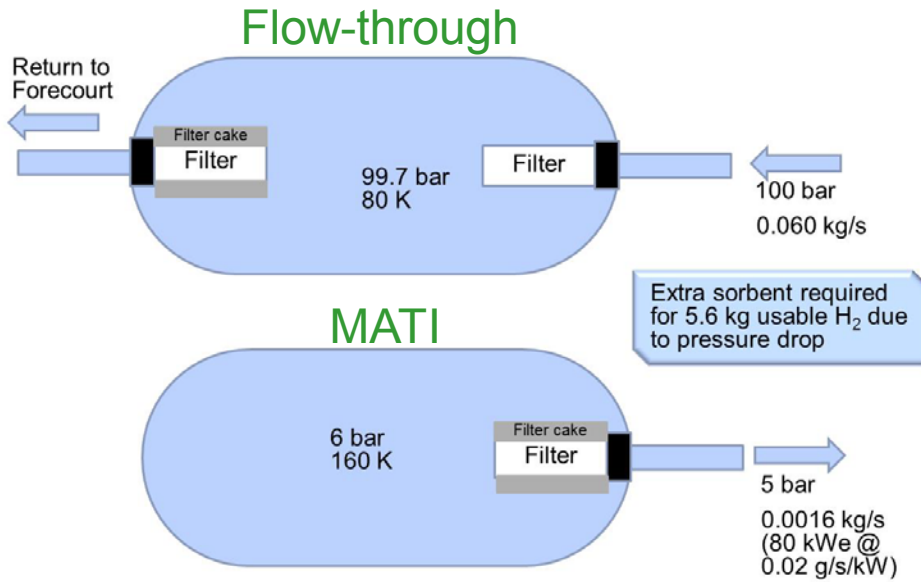

Right-Sizing

Moderate filter size (~49 cm²) of particulate filter with high permeability and particulate retention is a good compromise between weight and cost

Flow-through Cooling (Fill);
80K, 100 bar,
0.060 kg-H₂/s,
Filter permeability:
8.54e-13 m²
(without filter cake)

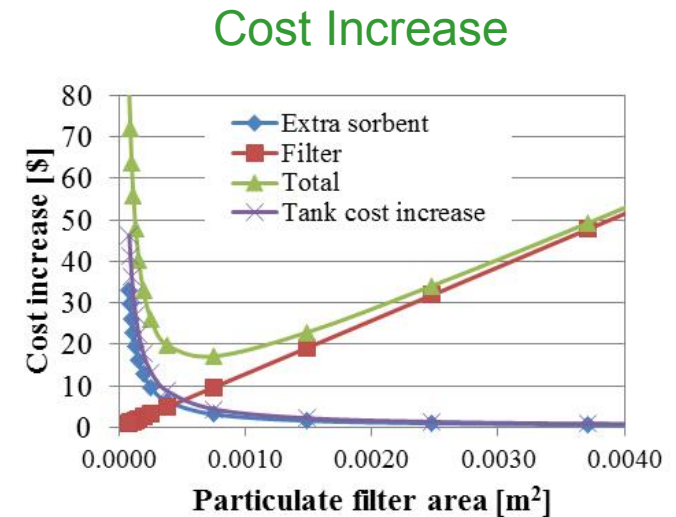
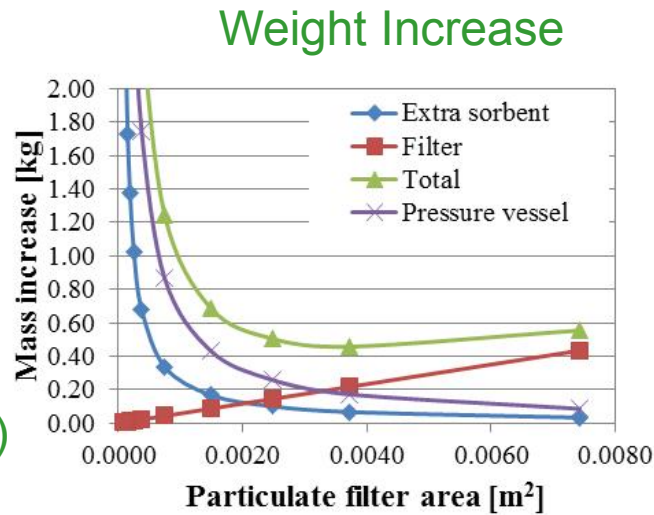

Near Empty-Tank (Driving);
160 K, 5 bar,
0.016 kg-H₂/s,
Filter permeability:
1.72e-13 m²
(with filter cake)

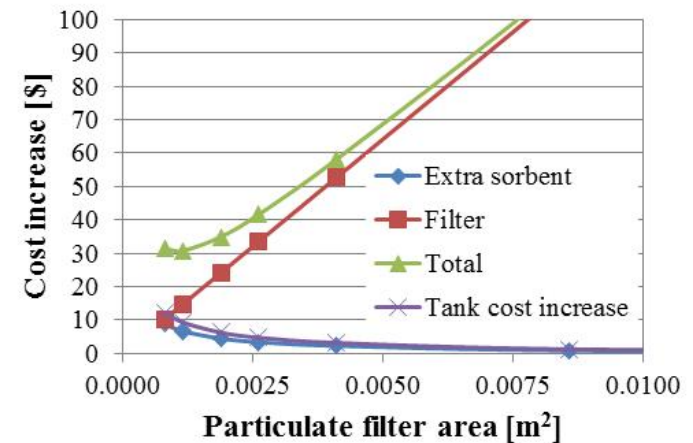
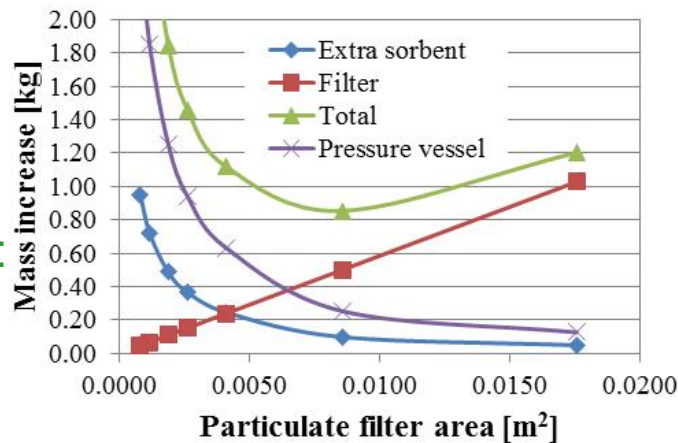

FY14 and FY15 Plan

Project end date: 6/30/2015

- March – June 2015:
 - Complete Adsorbent System Integration in Simulink® Framework
- July – September 2015:
 - Final Reports Preparation
 - Submit Results of HSECoE Project to Peer Reviewed Journals

Summary

Relevance: Design of materials based vehicular hydrogen storage systems that will allow for fast refueling and a driving range of greater than 300 miles.

Approach: Leverage in-house expertise in various engineering disciplines and prior experience with metal hydride system prototyping to advance materials based H₂ storage for automotive applications.

Technical Accomplishments and Progress:

- Developed graphical user interface (GUI) and performed beta tests.
- Supported integration of H₂ storage models into framework for public release.
- Demonstrated H₂ quality requirements with MOF-5 particulate filters.
- Developed a method for right-sizing of MOF-5 particulate filter in adsorbent system, including drop in filter permeability due to filter cake formation.

Future Work (July-September 2015):

- Final reports about UTRC's contributions to the materials-based H₂ storage systems of the HSECoE project:
 - Metal Hydride
 - Chemical Hydrogen Storage
 - Adsorbent

Answers to questions by reviewers

- The GLS development work was stopped in an orderly fashion as soon as the DOE decided to discontinue the work on the chemical hydrogen storage system development (Phase 2 to Phase 3 Go/No-Go decision). The results were presented at the MH2014 conference and published in a peer-reviewed journal. The Ammonia sorbent development was also published in a peer-reviewed journal.
- Hydrogen quality work was refocused on particulate mitigation for the cryo-adsorbent system, which was the only H₂ storage system of which the development continued in Phase 3 of the HSECoE project. The work would have benefited from having a clean room, which was not available at UTRC. A method was developed for right-sizing of the particulate filter area. The current AMR presentation clearly shows the effect of particulate filtration on the system weight and cost and how that impact can be minimized. The results were documented in a paper that will be published in a special issue of Applied Physics A, which is a peer-reviewed journal edited by Michael Hirscher.
- Funding for UTRC in FY2015 was limited to \$158k. This was just sufficient for supporting the Simulink® framework development and the models on the web. Beta-testing continued and the Simulink® framework with a graphical user interface (GUI) is now available on the HSECoE website at: www.hsecoe.org
- UTRC collaborated with HSECoE partners. UTRC also participated in Task 32: Hydrogen-based energy storage of the Hydrogen Implementing Agreement (HIA) of the International Energy Agency (IEA). UTRC is leading an activity on hydrogen storage for mobile applications within Task 32.

Acknowledgements

This material is based upon work supported by the U.S. Department of Energy under Contract No. DE-FC36-09GO19006.

The authors would like to thank all members of the HSECoE for stimulating discussions and Jesse Adams, Bob Bowman and Ned Stetson for their outstanding support. Special thanks to Donald Anton and Ted Motyka for leading the Hydrogen Storage Engineering Center of Excellence.

Disclaimer: This presentation was prepared as an account of work sponsored by an agency of the United States Government. Neither the United States Government nor any agency thereof, nor any of their employees, makes any warranty, express or implied, or assumes any legal liability or responsibility for the accuracy, completeness, or usefulness of any information, apparatus, product, or process disclosed, or represents that its use would not infringe privately owned rights. Reference herein to any specific commercial product, process, or service by trade name, trademark, manufacturer, or otherwise does not necessarily constitute or imply its endorsement, recommendation, or favoring by the United States Government or any agency thereof. The views and opinions of authors expressed herein do not necessarily state or reflect those of the United States Government of any agency thereof.

Questions and suggestions?



Technical Back-Up Slides

Drive cycles & test conditions in the framework: Hydrogen discharge scenarios designed to evaluate selected DOE System-level targets

Case	Test Schedule	Cycles	Description	Test Temp (°F)	Distance per cycle (miles)	Duration per cycle (minutes)	Top Speed (mph)	Average Speed (mph)	Max. Acc. (mph /sec)	Stops	Idle	Avg. H2 Flow (g/s)*	Peak H2 Flow (g/s)*	Expected Usage
1	Ambient Drive Cycle - Repeat the EPA FE cycles from full to empty and adjust for 5 cycle post-2008	UDDS	Low speeds in stop-and-go urban traffic	75 (24 C)	7.5	22.8	56.7	19.6	3.3	17	19%	0.09	0.69	1. Establish fuel economy (adjusted for the 5 cycle based on the average from the cycles) 2. Establish vehicle attributes 3. Use to size storage
		HWFET	Free-flow traffic at highway speeds	75 (24 C)	10.26	12.75	60	48.3	3.2	0	0%	0.15	0.56	
2	Aggressive Drive Cycle - Repeat from full to empty	US06	Higher speeds; harder acceleration & braking	75 (24 C)	8	9.9	80	48.4	8.46	4	7%	0.20	1.60	Confirm fast transient response capability – adjust if system does not perform function
3	Cold Drive Cycle - Repeat from full to empty	FTP-75 (cold)	FTP-75 at colder ambient temperature	-4 (-20 C)	11.04	31.2	56	21.1	3.3	23	18%	0.07	0.66	1. Cold start criteria 2. Confirm cold ambient capability – adjust if system does not perform function
4	Hot Drive Cycle - Repeat from full to empty	SC03	AC use under hot ambient conditions	95 (35 C)	3.6	9.9	54.8	21.2	5.1	5	19%	0.09	0.97	Confirm hot ambient capability - adjust if system does not perform function
5	Dormancy Test	n/a	Static test to evaluate the stability of the storage system	95 (35 C)	0	31 days	0	0	0	100%	100%			Confirm loss of useable H2 target

*Based on NREL simulation with compact vehicle, 5.6 kg usable H2, 80 kW fuel cell with a 20 kW battery

Test case 5 not implemented in the framework yet



This presentation does not contain any proprietary, confidential, or otherwise restricted information

Hydrogen vehicle simulation framework: overall structure

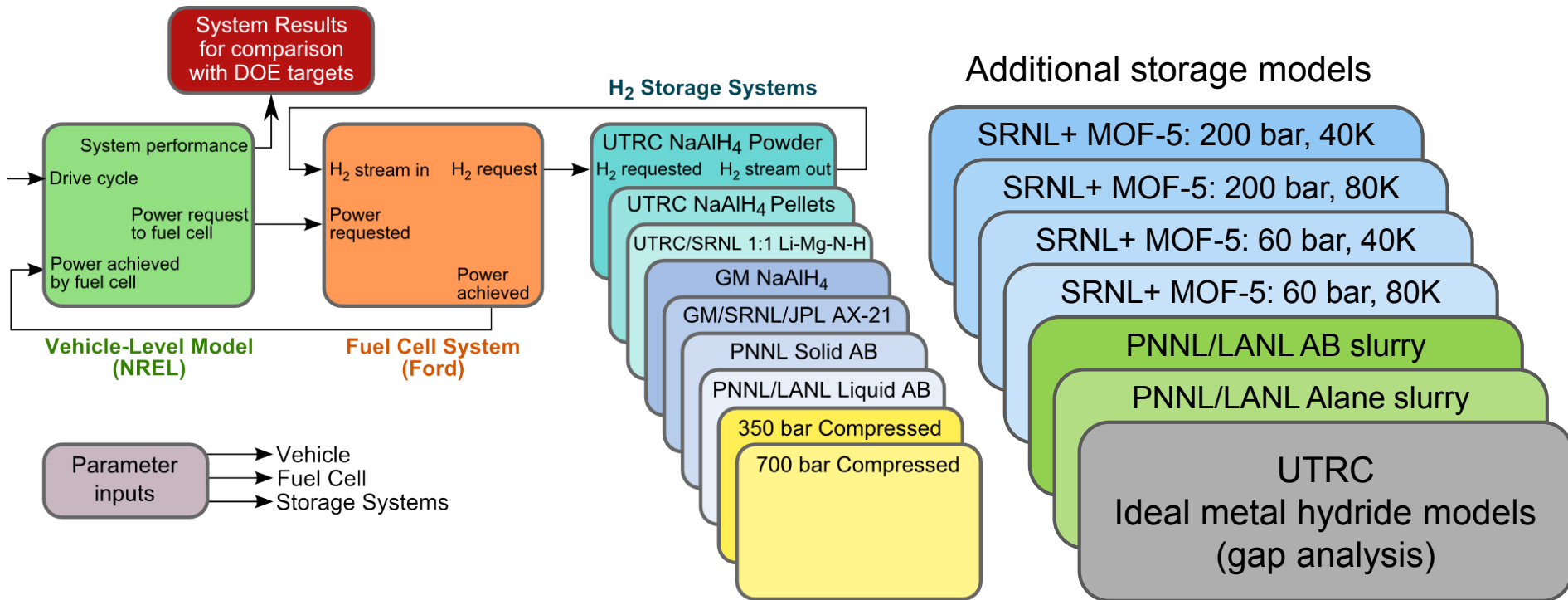

Drive cycles: H₂ discharge simulation

Benefits

- Fair comparisons: “all other things equal...” made explicit
- Well-defined interfaces allow independent development of storage modules.
- The framework also acts as a library of models

H₂ storage system interface

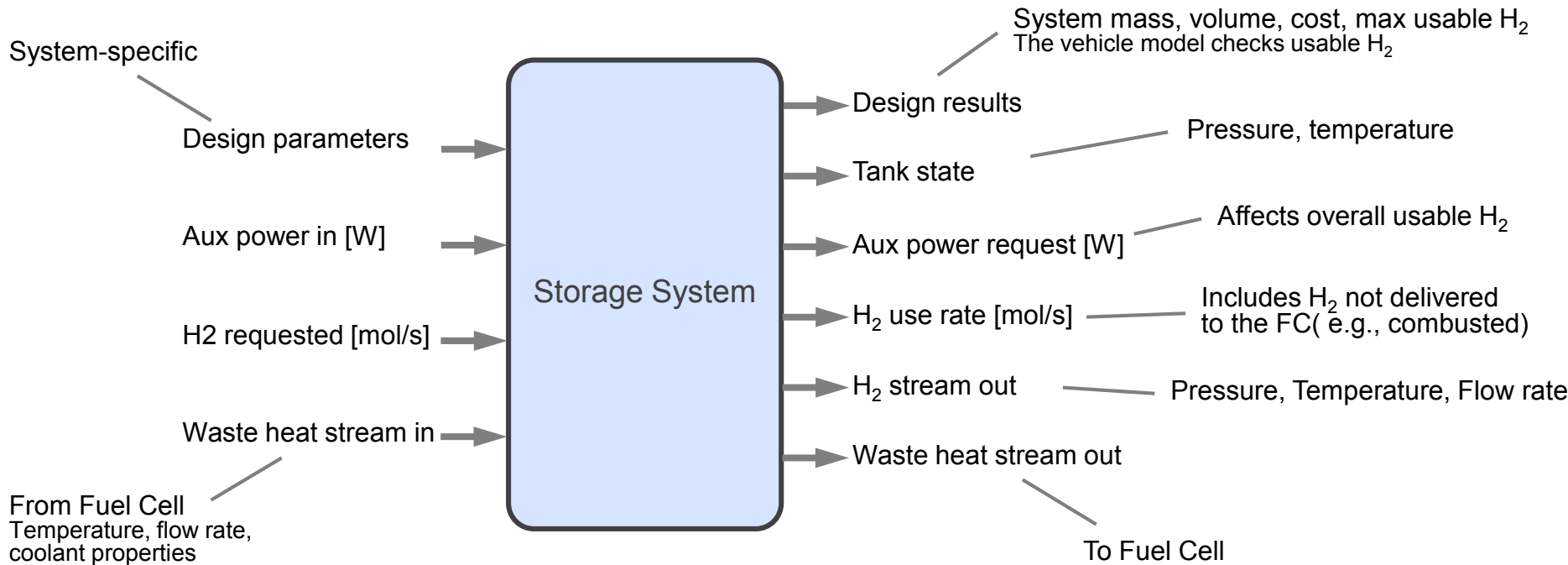
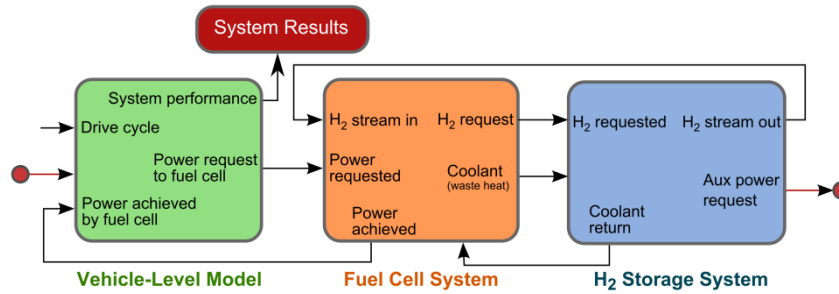

Relation between Acceptability Envelope & the Vehicle Simulation Framework

- For many systems, tank heat exchanger design is dominated by the requirement for a short refueling time.
- The framework is a discharge model: it does not currently size all BOP components, as main component sizes are dominated by refueling

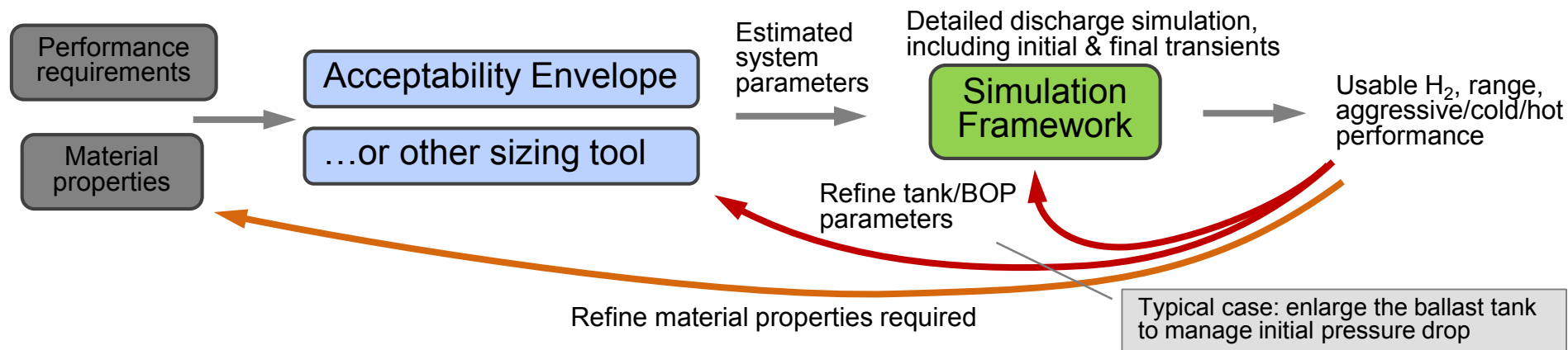

- Future development: incorporate some sizing into the framework

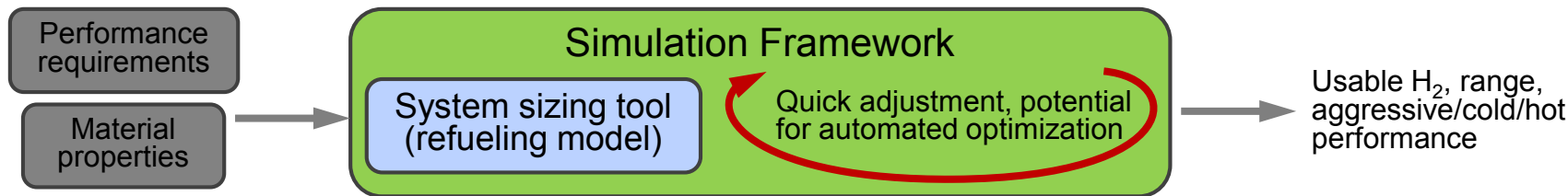

This presentation does not contain any proprietary, confidential, or otherwise restricted information