

Next Generation Hydrogen Storage Vessels Enabled by Carbon Fiber Infusion with a Low Viscosity, High Toughness Resin System

Brian Edgecombe
Materia, Inc.
June 9, 2016

DOE AMR

Project ID: ST114

Timeline

Project Start Date: 08/05/2014
Project End Date: 08/30/2016 (Original)
Proposed End Date: 12/30/2016
(No-Cost Extension)

Budget

Total Project Budget: \$3.0 M

- Total Recipient Share: \$1.0 M
- Total Federal Share: \$2.0 M
- Actual Spent: \$0.6 M / \$1.3 M

Barriers

- A. System Weight and volume
- B. System Cost

Key Partners

- Montana State Univ.- Bozeman Composite Technologies Research Group (Prof., Doug Cairns)
- Spencer Composites Corp.
- Hypercomp Engineering

Overall Objective for 2-Year Project:

The demonstration of a 700-bar, Type IV Composite Overwrap Pressure Vessel (COPV) with:

- (1) Reduction in Carbon-Fiber(CF) composite volume by 35%
- (2) Cost of composite materials of \$6.5/kW-hr. This component cost is an important element of the system cost project target of \$12/kW-hr
- (3) Performance maintained (burst strength of 1575 bar and 90,000 cycle life)

Objectives, FY 2016	Completion Date
Evaluate static properties and void content on test plates	Done
Prepare and burst small tanks via infusion process	Done
Scale up process to full scale COPVs	8/30/2016
Demonstrate path to savings on CF and cost	12/31/2016

Impact on FCTO Technical Barriers: A. System weight and volume
B. System Cost

Approach: Technical Premise

Enabling CF reduction of COPV through alternative processes and resins

- Reduction in void defects in the composite wall by using vacuum infusion processing of dry-wound forms enabled by a very low viscosity resin
- Use of high fracture-toughness resin (Proxima® ACR) with better fatigue performance and crack resistance for resin-sensitive tangent region
- Leveraging low-void and toughness in COPV design approach

Project Challenge

- Producing low-permeability, CF dry-wound structures using vacuum infusion process
- Optimizing COPV design and winding for optimal performance-cost ratio

Received “Go” in Fall 2015 by demonstrating feasibility to meet target 35% CF reduction through models and small prototypes.

✦ Approach: Maximizing Damage Tolerance

- Voids can cause large knock-downs in shear strength which is relevant in the “shoulder region” of COPVs
- Susceptibility of damage in the shoulder region during 45 degree drop test can force designs with more CF weight

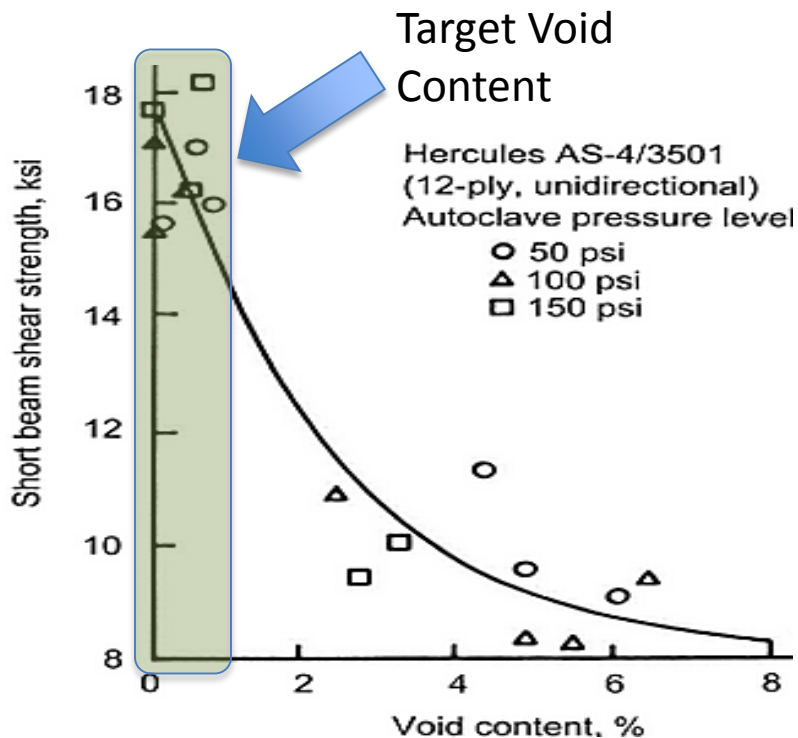

Sensitive
“shoulder region”

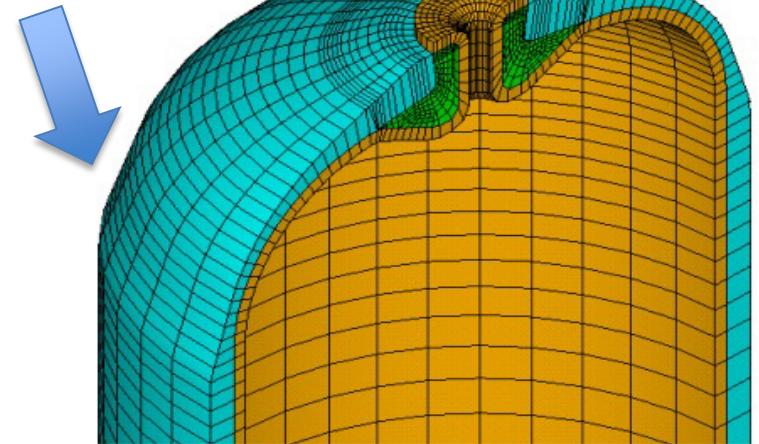

Matrix with higher damage tolerance and lower voids would be preferred

Approach: Project Phases and Key Milestones

FY2015

- Project start-up**
- Infused Thickness, > 30 mm**
- Show low void content (<1 %)**

Demonstrate infusion process feasibility (Thin and thick plates)

FY2015 / 16

- Predict effect of toughness, voids, fiber on tank (M6.1, 6.2, 6.3)**
- Design tank with lower CF content (M9.2)**

Design tank using models and materials data (static and fatigue)

FY2016

- Supported by modeling work (M6.1,6.3)**

Extend process to small tank prototypes

FY2016/2017

- Produce a series of tanks during optimization**
- Test tanks for performance**

Demonstrate and refine process / performance in full-scale design

Approach: Project Team

- Materia's low viscosity resins (< 20 cP) enable vacuum infusion of thick carbon fiber laminates with low void content ($< 1\%$).
- Project partners bring expertise in composite testing, characterization and modeling (Montana State Univ) and non-traditional filament winding (SCC)

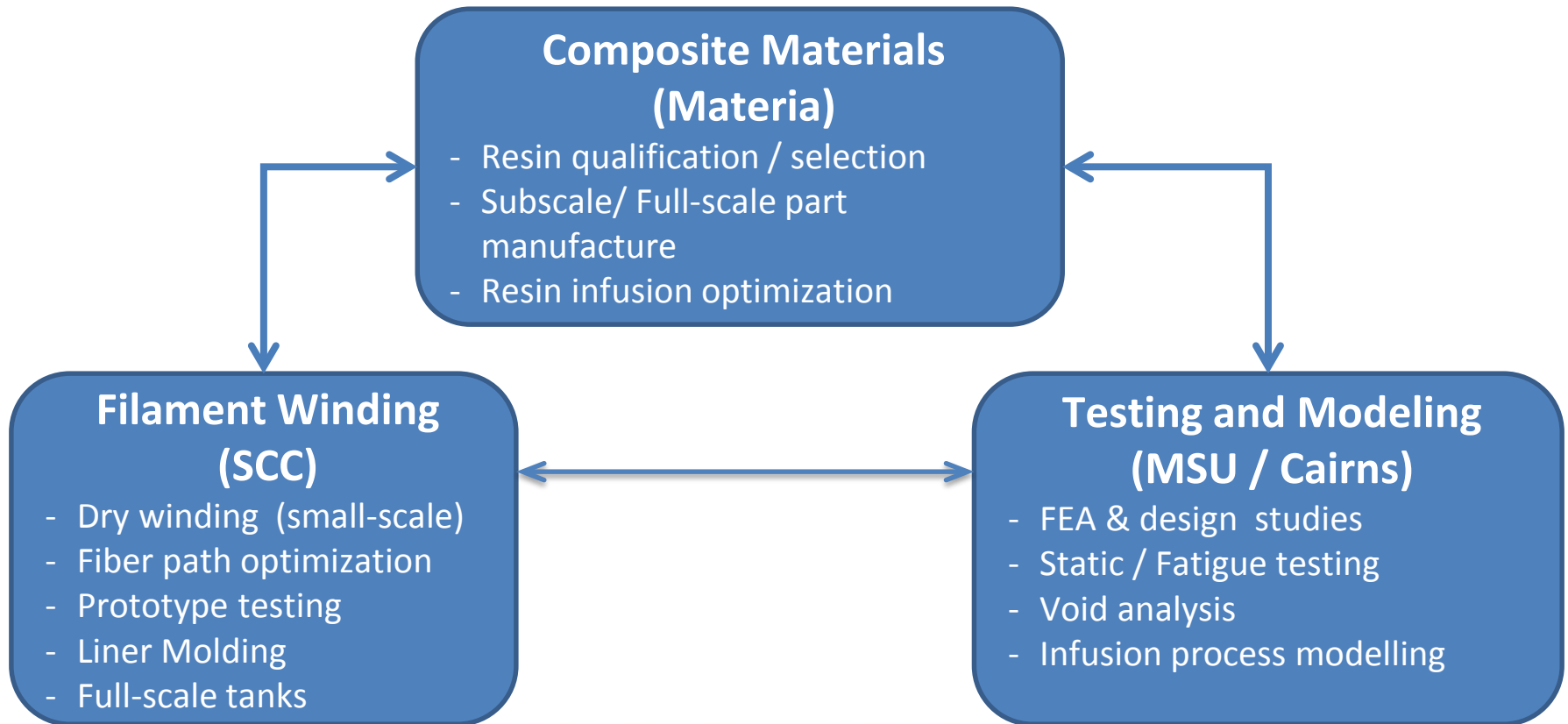



Accomplishment and Progress: Summary

Task	Status
Optimize processing / Formulation for infusion of plates	Completed
Develop data set of key mechanical properties (static)	Completed
Conduct dynamic testing on composite plates	Completed
Prepare small tanks (Type 3) as “Proof of Principle” for process	Completed
Design COPV winding pattern for full-size Type 4 tanks	Completed
Optimize infusion on full-scale tanks with aid of infusion models	Jun-2016
Manufacture full-size tanks with CF Reduction and test	Oct-2016

Time	Key Milestones & Deliverables
Year 1	Demonstrate 35% reduction in CF laminate and a composite cost of 6.5 \$/kW-hr in subscale parts (Completed)
Year 2	Produce prototype tanks with reduced CF overwrap that reach DOE 2020 Gravimetric target (1.8 kW-hr / kg)

Accomplishment: Success with COPV Infusion

Through process optimization, infusion of high quality, small COPV was achieved with typical CF content

Vacuum vent

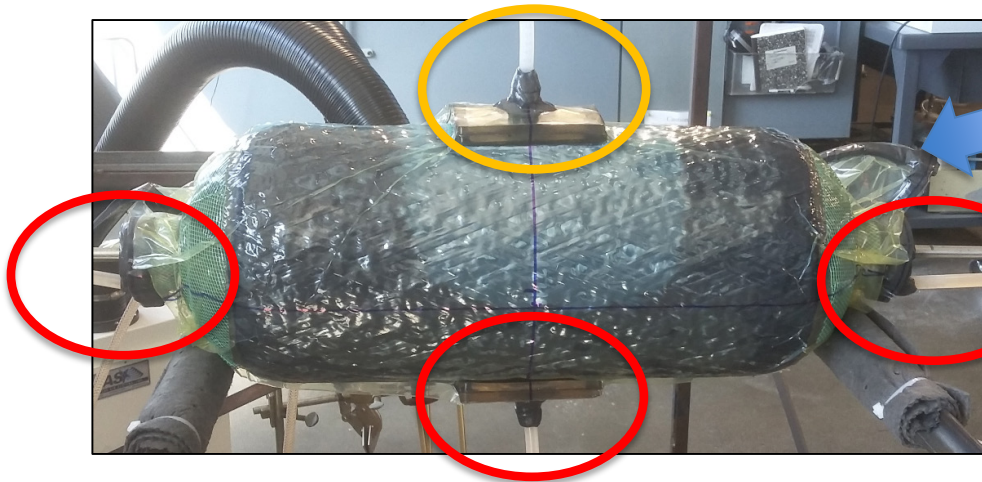

Tank wrapped in bagging film, sealed with gasket tape

Resin inlets at each dome and lowest point

Tank Details: 7.5 Liter Type 3, 6" diameter x 18" length

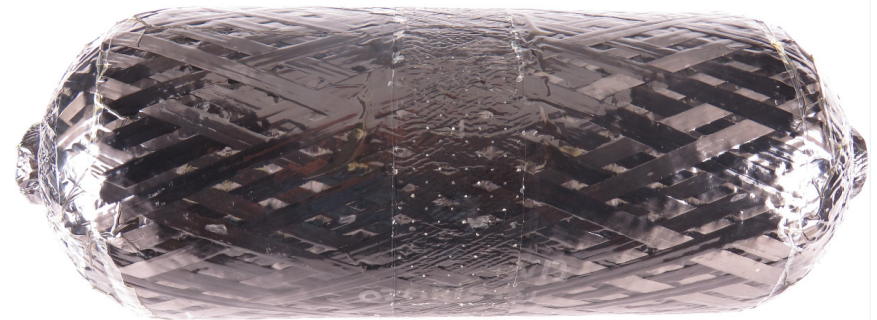

Take Home: Proof of Concept shown and optimization (placement of ports) has reduced infusion time from 2 hours to 0.5 hr for 7.5 Liter tanks (non-optimized).

Accomplishment: Lower Void Content Confirmed

Void characterization conducted on small tanks

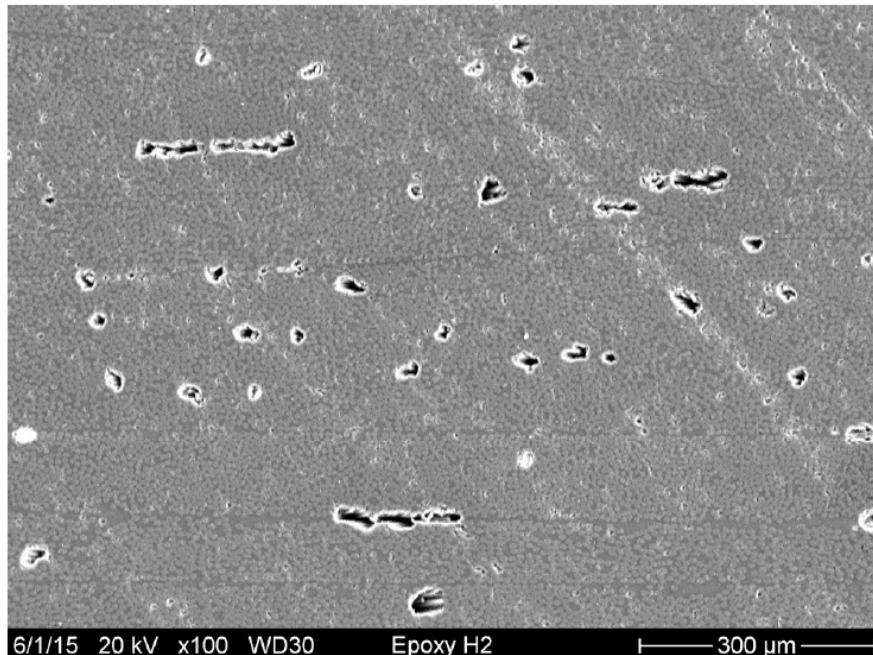

Epoxy coupon H at 100X magnification.

**Wet-wound epoxy tank with voids
(3 to 9% voids across 7 regions)**

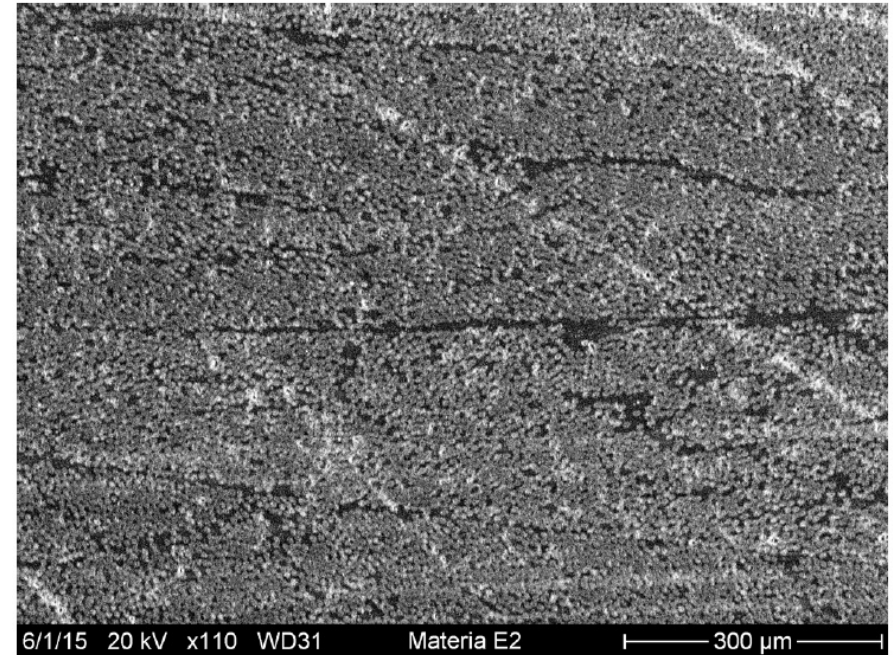

Proxima coupon E at 110X magnification.

**Infused tank with no voids across 7
regions. Some evidence of resin-rich
areas may suggest wrinkles in early tanks**

Take Home: COPV with low void content (<0.5 vol.%) is achievable with infusion

Accomplishment: Summary of Burst Types

Optimization in vacuum infusion process then in winding pattern resulted in significant improvements in burst strength of 7.5 Liter, Type III tanks



1001 bar
14,524 psi

Crimping / Fiber buckling



Dome failure

1694 bar
(25,569 psi)



1833 bar
(26,586 psi)

Hoop Failure !!

Accomplishments: Small COPVs Burst Tests

Through stages of optimization in the vacuum infusion process and the winding pattern, excellent delivered fiber strength was obtained.

Fabrication Type	Resin	Winding	Burst Strength	Demon. Fiber Strength	% Deliv. Fiber Strength
Wet Wound	Anhydride-Cure Epoxy	Winding Pattern #1	1834 bar (26,595 psi)	693 ksi	92
Dry Wound/ Resin Infused	Proxima ACR	Winding Pattern #1	1001 bar 14,524 psi	356 ksi	47
Dry Wound/ Resin Infused	Proxima ACR	Winding Pattern #1	1694 bar (25,569 psi)	634 ksi	84
Dry Wound/ Resin Infused	Proxima ACR	Winding Pattern #2 to minimize gaps	1833 bar (26,586 psi)	732 ksi	97

Burst strength of small-scale tanks based on Toray T700, 24K (Type III, designed for 1575 bar minimum burst by HEI)



Accomplishment: Troubleshooting the Process

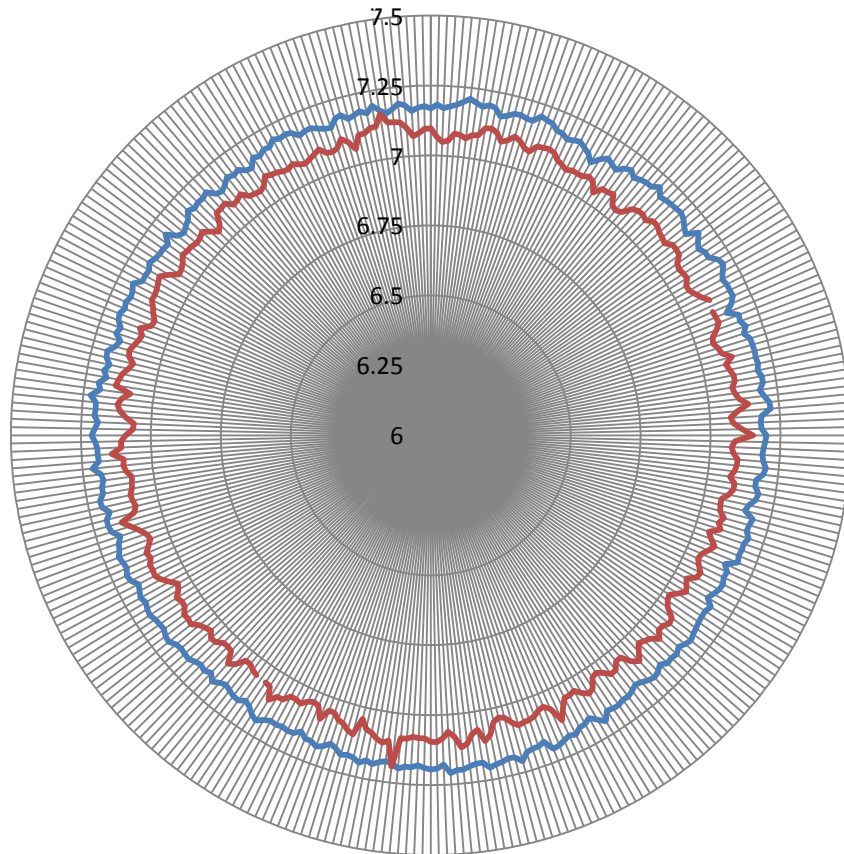

- Vacuum process causes various degrees of fiber compaction, dependent on winding tension
- Compaction results in higher fraction of fiber in composite wall (i.e. thinner wall but same CF weight / volume)
- Processes that cause localized areas of compaction were correlated with fiber buckling and thus avoided

— Before vacuum infusion
— After vacuum infusion

Take Home: Using non-contact measurements, risks of fiber crimping or buckling can be identified

Accomplishment: Success with Full-size Dry Winding

- Materia took delivery of the first full-size tank in FY2016.
- Process optimization for vacuum infusion is underway



Take Home: Dry-winding success but infusion optimization is needed

Accomplishments: Improved Residual Strength after Fatigue, Moderate Void Content

- Tension-tension cycling performed on glass fiber composite plates at 0.7% strain (corresponding to hoop strain at max. operating conditions)
- During composite prep, defects were introduced to composite via controlled air-leak
- After cycling, composite laminates with tougher resin showed excellent retention of tensile strength with moderate void content.

Resin Type	Anhydride- Epoxy		Proxima	
	Initial	90K Cycles	Initial	90K Cycles
Void %	1.1		1.6	
Specimen Conditioning	Initial	90K Cycles	Initial	90K Cycles
Tensile Strength (MPa)	680	477	667	631
Strength Retention after Cycling		70%		95%

Take Home: Composite residual strength is improved with tougher resin even at 1-2% voids

✦ Accomplishment: Use of Models for Mechanical Analysis and Infusion Flow

- MSU ABAQUS model of new design. Further optimization is in progress
- Flow model has been completed to aid experiments

Port Placement Optimization

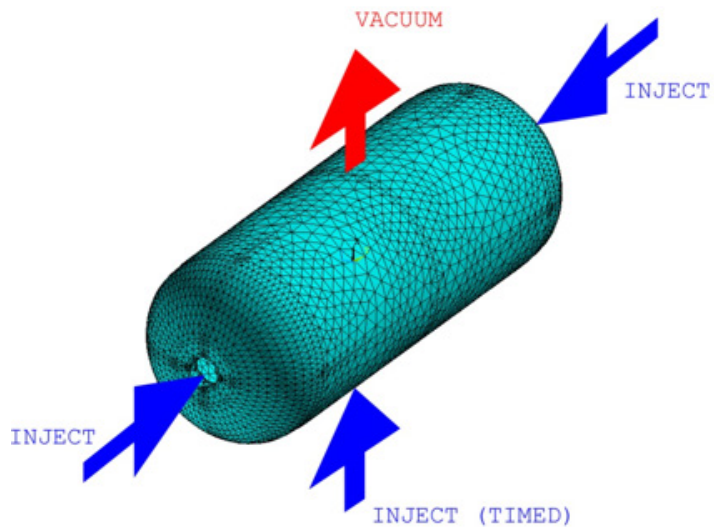

Fill Time Prediction

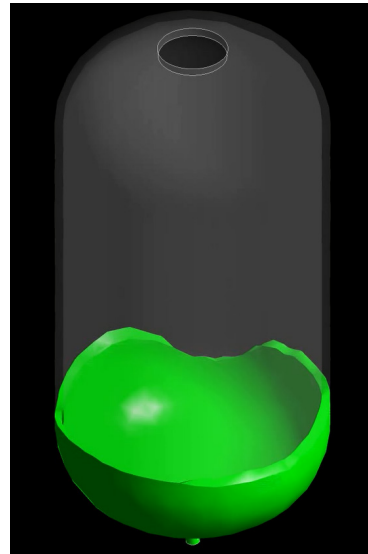

FEA Model

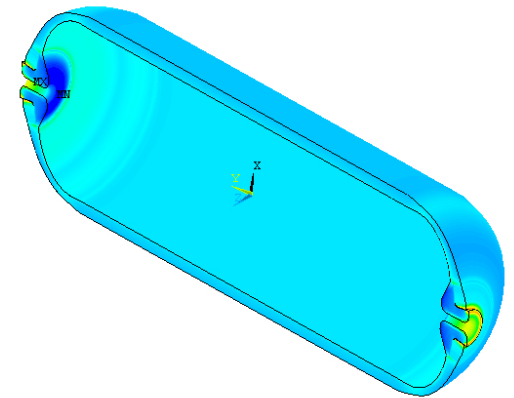

Take Home: Infusion models has provided feedback on port placement and FEA has given complementary view on preliminary models



Accomplishments: Design Summary

Model Parameters for 700 bar, Type IV tank (147 Liter)

Parameter	DOE 2013 Model	Current Project Model	Comment
CF Tow	711 psi (Toray T700)	800 psi (MRC 37-800)	MRC tow: easier to procure
Allowable Fiber Stress Approach	CF variability = 90% Winding efficiency = 80%	Burst Testing of Filament Wound Rings	
Allowable Fiber Stress	512 ksi	650 ksi	
Stress Ratio	0.60	0.75	Assumed lower dome failure risk with tough, low void resin
Thickness, cylinder	31.9 mm (ABAQUS)	21 mm (Netting) 25 mm (ABAQUS)	22% to 34% CF reduction anticipated from models

Team member SCC has burst testing history with Stress Ratio = 0.75 showing cylinder hoop failures when dome shape and fiber placement are optimized.

The cylinder-dome transition region where shear stresses are observed is especially sensitive to defects.

Take Home: Models suggest CF savings obtainable assuming tough, low-void matrix can support hoop failures for $SR > 0.6$

Accomplishment: Cost Estimation Model

From Strategic Analysis's cost model (using conservative 4-hr infusion time) the reduction in composite has strong cost reduction potential in spite of extra process steps

Vacuum infiltration single variable sensitivity analysis based on preliminary assessment of Materia process

(baseline cost = \$12.03/kWh)

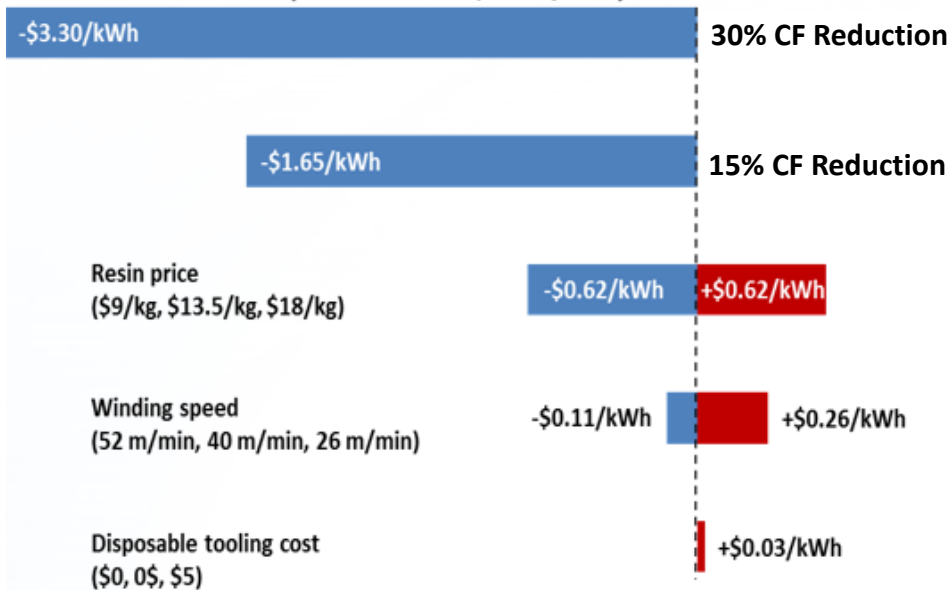

Baseline costs (before CF Reduction)

Manufacturing Cost = \$1.04/kWh

- Winding Cost = \$0.53/kWh
- Infiltration Cost = \$0.51/kWh

Composite Material Cost = \$10.99/kWh

- CF Cost = \$9.03/kWh
- Resin Cost = \$1.84/kWh

Comparison from Strategic Analysis Versus 2013 Base Case

Take Home: Significant potential for cost savings through CF reductions vs. small processing cost changes

Response to Previous Year Reviewers' Comments

“Data supporting the approach was not presented. The basis for the aggressive project goals are unclear. No correlation between void concentration and performance is given..”

The presentation in 2015 was only 6 months into the project and data was not well-developed yet. Data on small tanks has been presented and fatigue results shown. Design assumptions have been more clearly highlighted.

“The project needs to assess the baseline COPV design to evaluate the potential improvements of the approach. The linkage of the proposed improvements to the 35% CF reduction is not shown.”

A more systematic comparison of the Project design vs. the 2013 base case has been summarized.

“The project did not provide cost models or specific performance metrics relating to void content.”

Cost estimates have been included by working with SA

Collaborations

Organization	Category	Role
Materia Inc	Industry (Chemicals)	Resin selection and infusion process optimization
Spencer Composites Corp. (SCC)	Industry (Fila. Winding)	Filament winding, fiber winding modelling, burst testing
Montana State University – Bozeman (MSU)	University (Composites Lab)	FEA modelling, mechanical testing,
Hypercomp Engineering	Industry (Fila. Winding)	Supplier / Test Lab only; Some modeling
Powertech Labs	Industry	Test Lab only

Remaining Challenges and Barriers

The prediction accuracy of mechanical models is not well known

- Mitigation: Sufficient number of COPVs will be prepared for iterative analysis. Models will be refined based upon data.

Large COPV infusion remains as a technical challenge

- Mitigation: In order to leverage resin toughness, wet winding methods will be considered if infusion is intractable within timeline

Acceptance of new processes (e.g. infusion) within COPV industry is not straightforward.

- Mitigation: Team will investigate alternative methods to simplify the infusion approach

Proposed Future Work

- (1) Optimize winding and infusion processes for COPVs (FY 2016)
- (2) Verify properties via burst tests (FY 2016)
- (3) Refine designs and models as needed based on data (FY 2016)
- (4) Produce tanks for drop tests and cyclic loading (FY2017)

Technology Transfer Activities

- Materia has begun preliminary discussions with COPV producers to understand the key data needed
- Further discussions will continue as key data becomes available
- No IP has been identified at this time



Summary Table

Objective	Project Target	FY16 Status
Prepare small COPVs and burst	Validate low voids	Demonstrated 1833 bar burst pressure
Measure mechanical effect of voids	Fatigue testing	Retained 95% strength after 90K cycles
Prepare full size COPVs and simplify process	Low void tanks	Done
Demonstrate CF reduction with good burst strength	May 2016	Extended per no-cost extension
Demonstrate CF reduction in other tests such as 45° drop	August 2016	Extended per no-cost extension

- Steady progress continues, but important milestones during next 8 months
- The project does not see any deal-breakers yet

Back-Up Technical Slides

✦ Accomplishment: Success with COPV Infusion

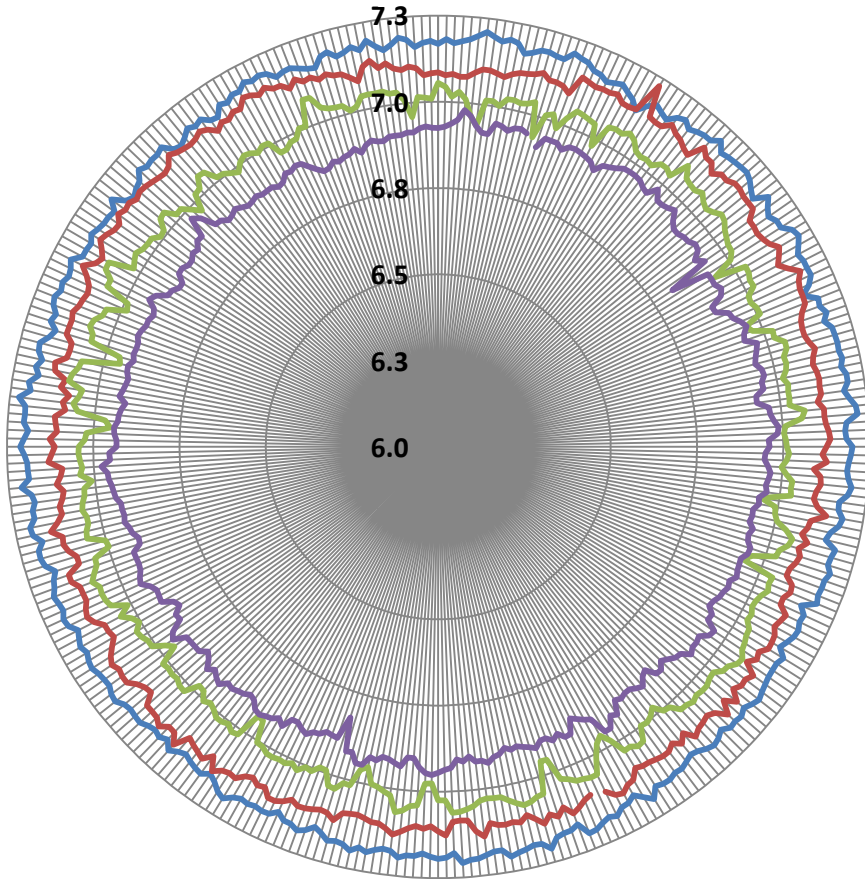

- Vacuum process causes some fiber compaction, dependent on winding tension
- Compaction results in higher fraction of fiber in composite wall. Therefore, thinner wall but same CF weight.
- Processes that cause localized areas of compaction were correlated with fiber buckling and thus avoided

Tank	Tension	Diameter
N9	5-8 Lbs.	7.181"
N11	8-10 Lbs.	7.119"
N12	10-12 Lbs.	7.024"
N13	12-14 Lbs.	6.927"

Take Home: Using non-contact measurements, changes in diameter associated with fiber crimping or buckling can be identified

Lay-up Steps

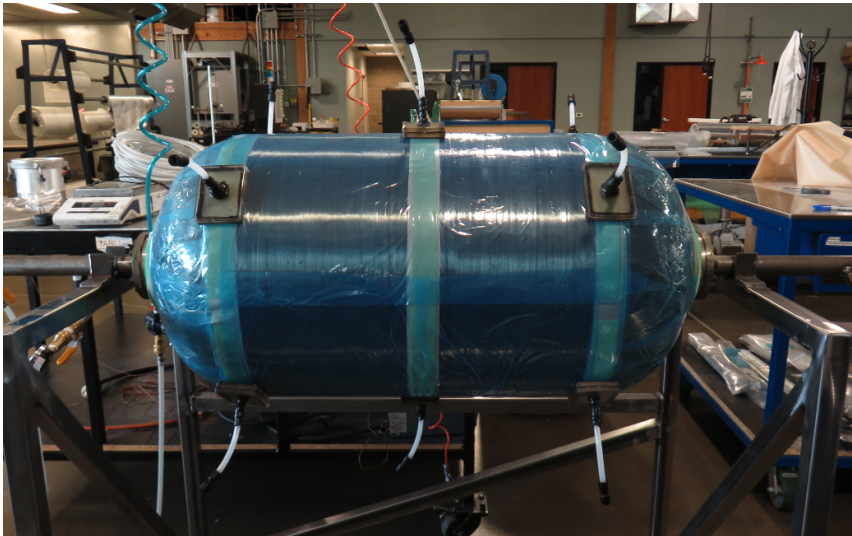
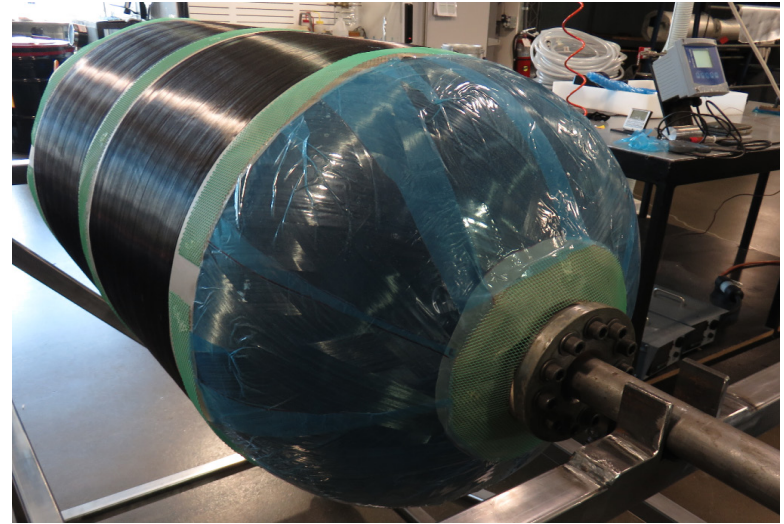
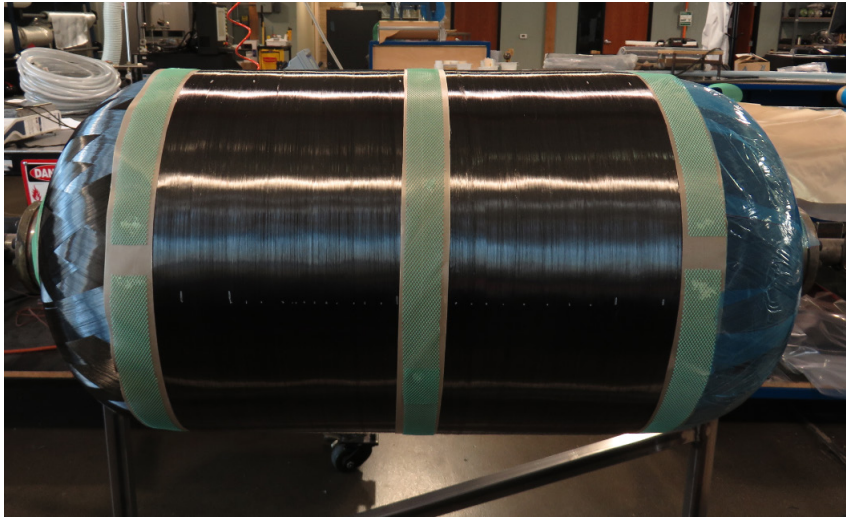

Preliminary Infusion Scenarios

SCENARIO 1

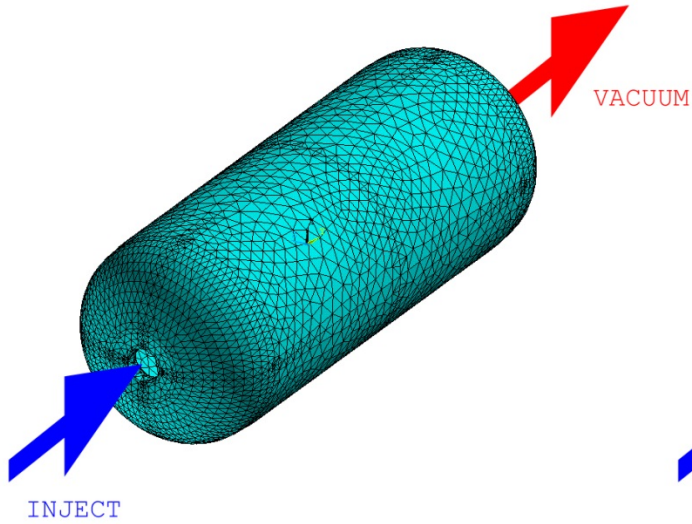

SCENARIO 2

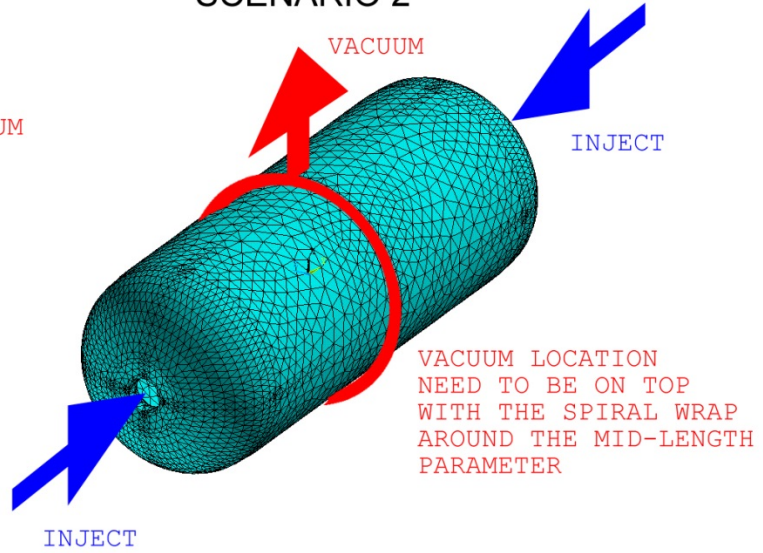

SCENARIO 3

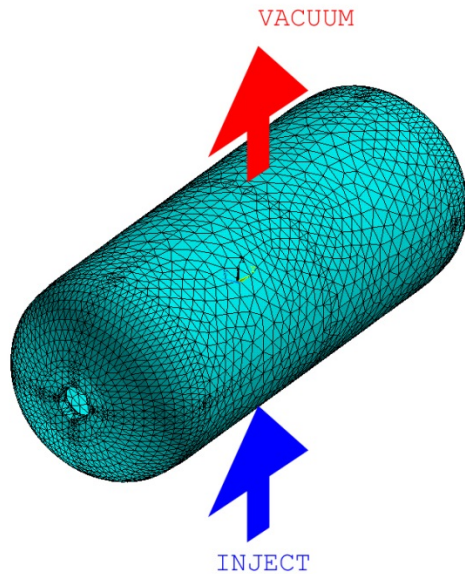

SCENARIO 4

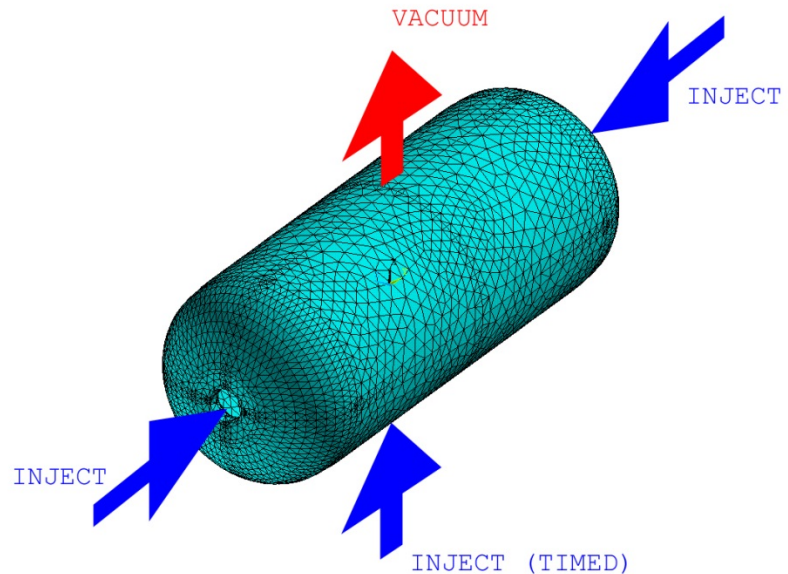

Progress toward DOE Targets

Project goals were created to respond to DOE targets

Comparative Summary of Key DOE Metrics for Hydrogen Storage Systems

Hydrogen Storage Systems	System Wt. (kg)	System Vol (L)	System Cost (\$ / unit)	Key DOE Metrics for Hydrogen Storage Projects			Comment
				Gravimetric (kW-h/kg sys)	Volumetric (kW-h/L sys)	System Cost (\$/kW-h, at 500k units/yr)	
Year 2017 DOE Target	104	224	2238	1.8	1.3	12	Ref. 1
Yr 2013 700-bar Type IV, Base Case	128	224	3171	1.5	0.8	17	Ref. 1
Proposed 700-bar Type IV	106	215	2313	1.8	0.9	12	Proposed

		Year 2013	Proposed
Composite Material cost	\$/kWh	\$10.4	\$6.5
Composite Processing Costs	\$/kWh	\$1.0	\$0.5
Other System costs (Non-composite)	\$/kWh	\$5.4	\$5.4
Total System Cost	\$/kWh	17	12

Ref. 1: McWhorter, S., Ordaz, G., "Onboard Type IV Compressed Hydrogen Storage Systems – Current Performance and Cost," *DOE Fuel Cell Technologies Office Record Number 13010*, June 11, 2013.