

the Energy to Lead



Performance Evaluation of Delivered Hydrogen Fueling Stations

Principle Investigator: Ted Barnes
Gas Technology Institute
June 7, 2016

Project ID: TV025

This presentation does not contain any proprietary, confidential, or otherwise restricted information

Overview

Timeline

- Start: 03 / 2013
- End: 01 / 2018
- Progress: 40% Complete

Budget

- Total Spent: \$211,198*
- Total Project Value: \$800,000
- Cost Share Percentage: 50%

* as of 3/31/2016

Barriers

- D. Lack of Hydrogen Refueling Infrastructure Performance and Availability Data
- E. Codes and Standards

Partners

- Gas Technology Institute (GTI)
- Linde, LLC.

Relevance

DOE Technical Objectives	Project Team Goals	Period Goals
1. Confirm performance of systems in real world applications through data collection.	<ul style="list-style-type: none">• Install data collection systems at (5) 100 kg/day delivered hydrogen fueling stations in CA for 24 month period.	<ul style="list-style-type: none">• Complete data system installation at last 4 fueling stations
2. Provide the public with aggregated data presented in composite data products, and secure confidential data in National Fuel Cell Technology Evaluation Center (NFCTEC).	<ul style="list-style-type: none">• Submit station data specified in the NREL Hydrogen Station Data Templates.	<ul style="list-style-type: none">• Submit station data to NREL for all active fueling stations
3. Benchmark station capacity, utilization, maintenance, and safety.	<ul style="list-style-type: none">• Provide useful data to accurately characterize stations' performance.	<ul style="list-style-type: none">• Begin collecting high quality data on all stations

Approach: General

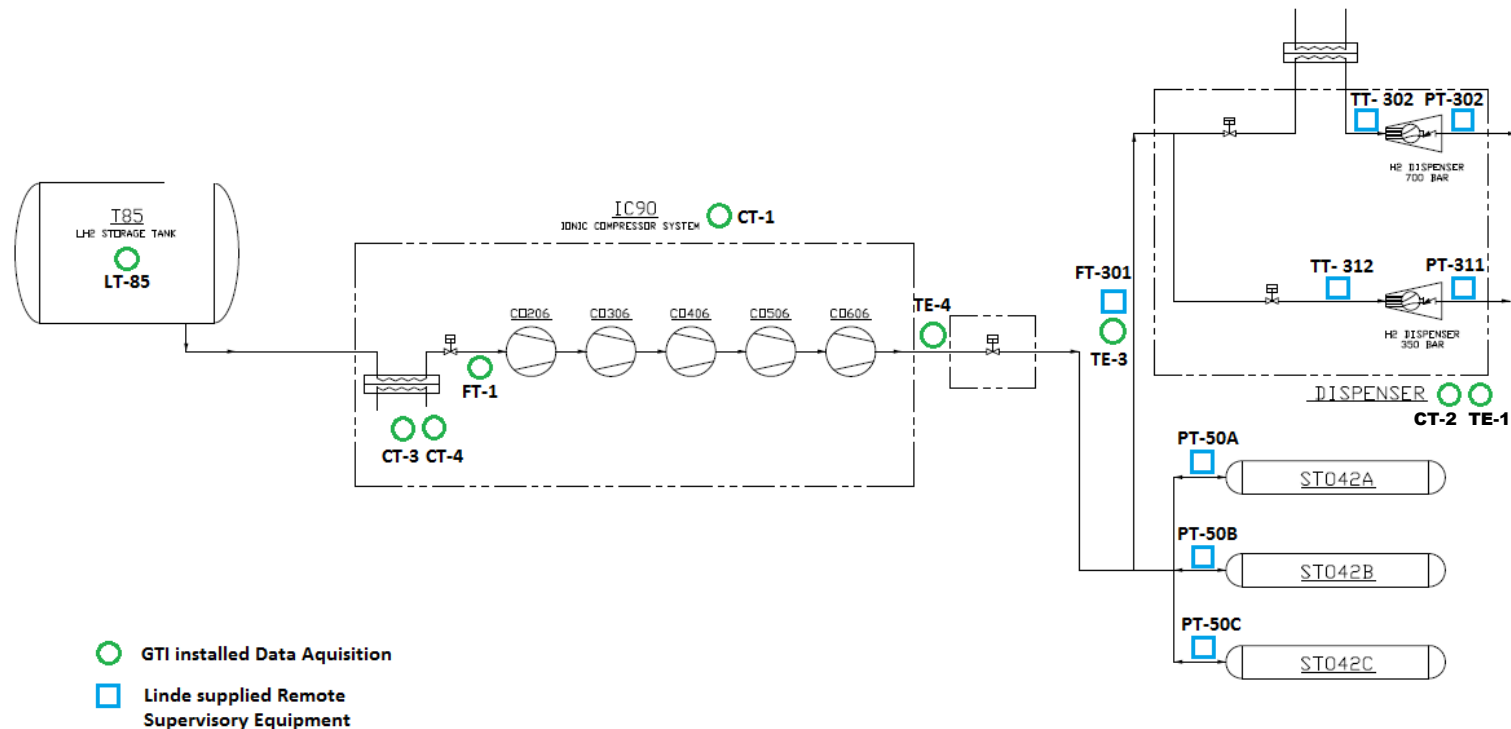

- A combination of the techniques and coordination between Linde's station controls and GTI's data acquisition system are required to meet project objectives.

Approach: General

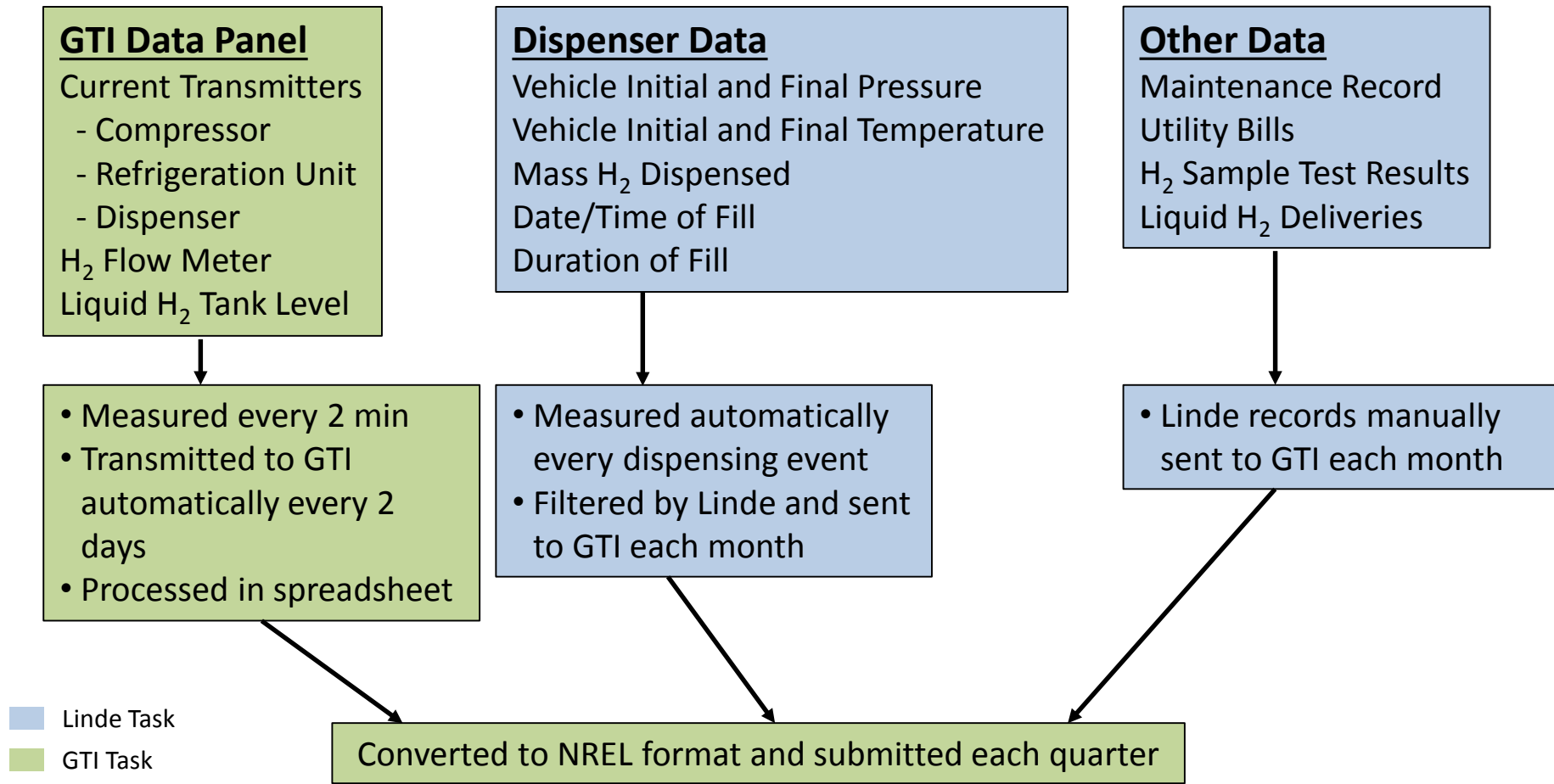

Approach: Budget Period 1

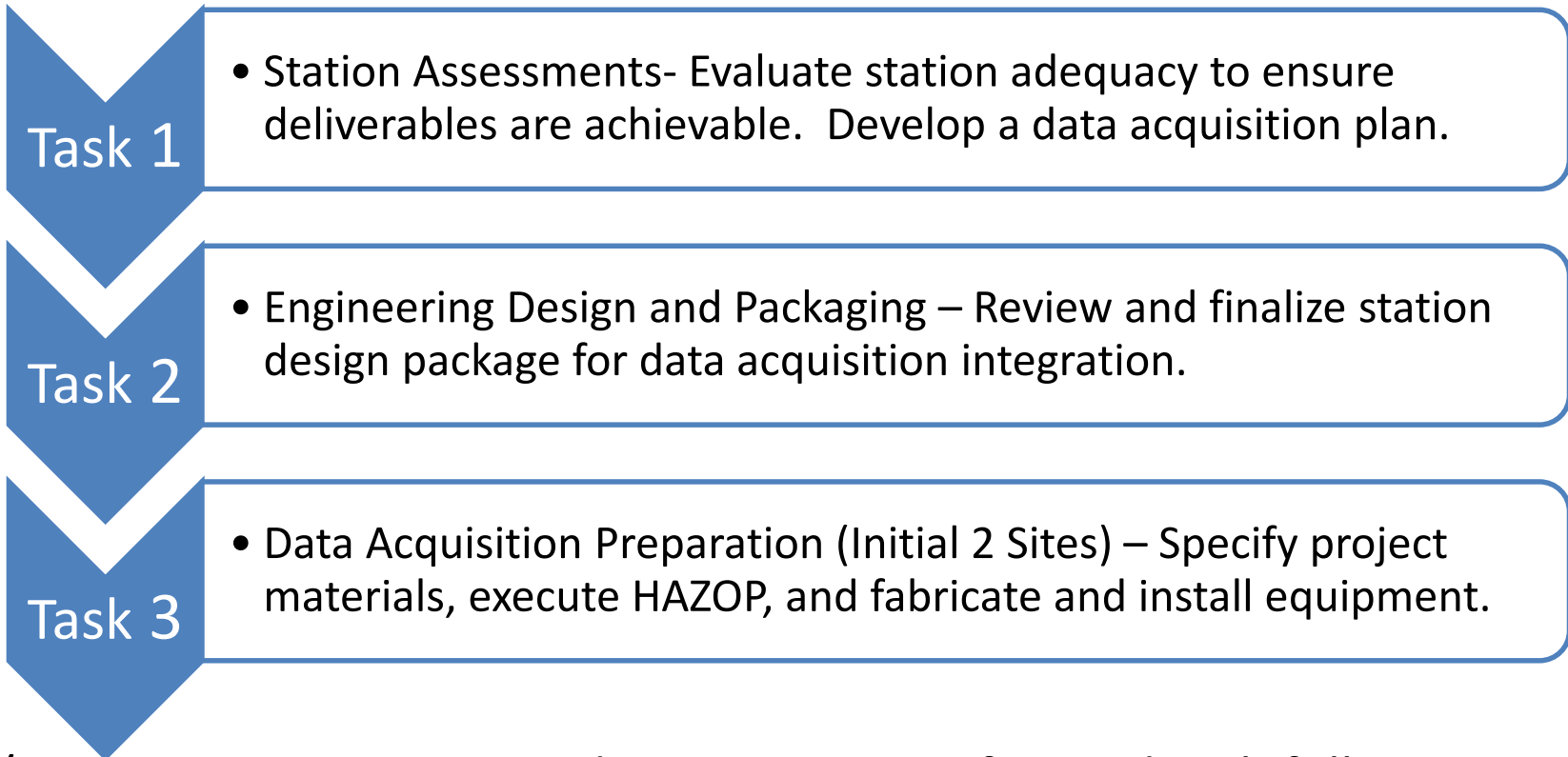

Go/ No Go Decision Point: A decision to move forward with full project scope will depend on project team's ability to supply complete sets of data for initial 2 sites.

Approach: Budget Period 2

Task 4

- Data Acquisition Preparation (Remaining 3 Sites) – Specify project materials, participate in HAZOP, and fabricate and install equipment.

Task 5

- Data Collection– Collect data on each station over full performance period (2 years). Maintain equipment and system integrity through periodic inspections and maintenance.

Task 6

- Data Analysis and Reporting – GTI will compile data from equipment and Linde operations and submit to the HSDC on a quarterly basis throughout the life of the project.

Accomplishments and Progress

- System installed and collecting data at West Sacramento and San Juan Capistrano sites.
- San Ramon data acquisition system built; awaiting construction of station.

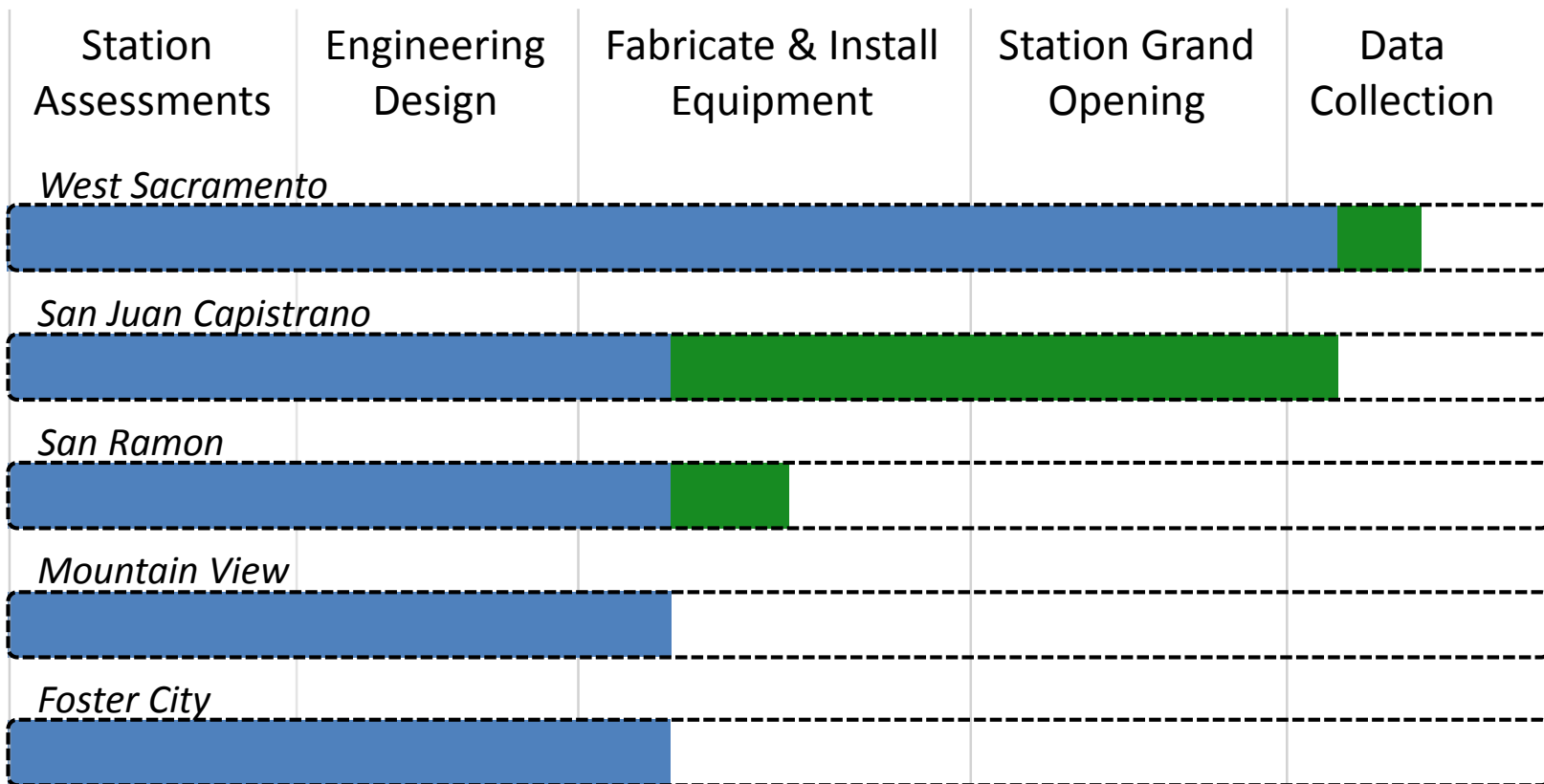

*** Green bars are progress since last AMR*

Accomplishments and Progress

As of 10/1/2015, project has transitioned to Budget Period 2

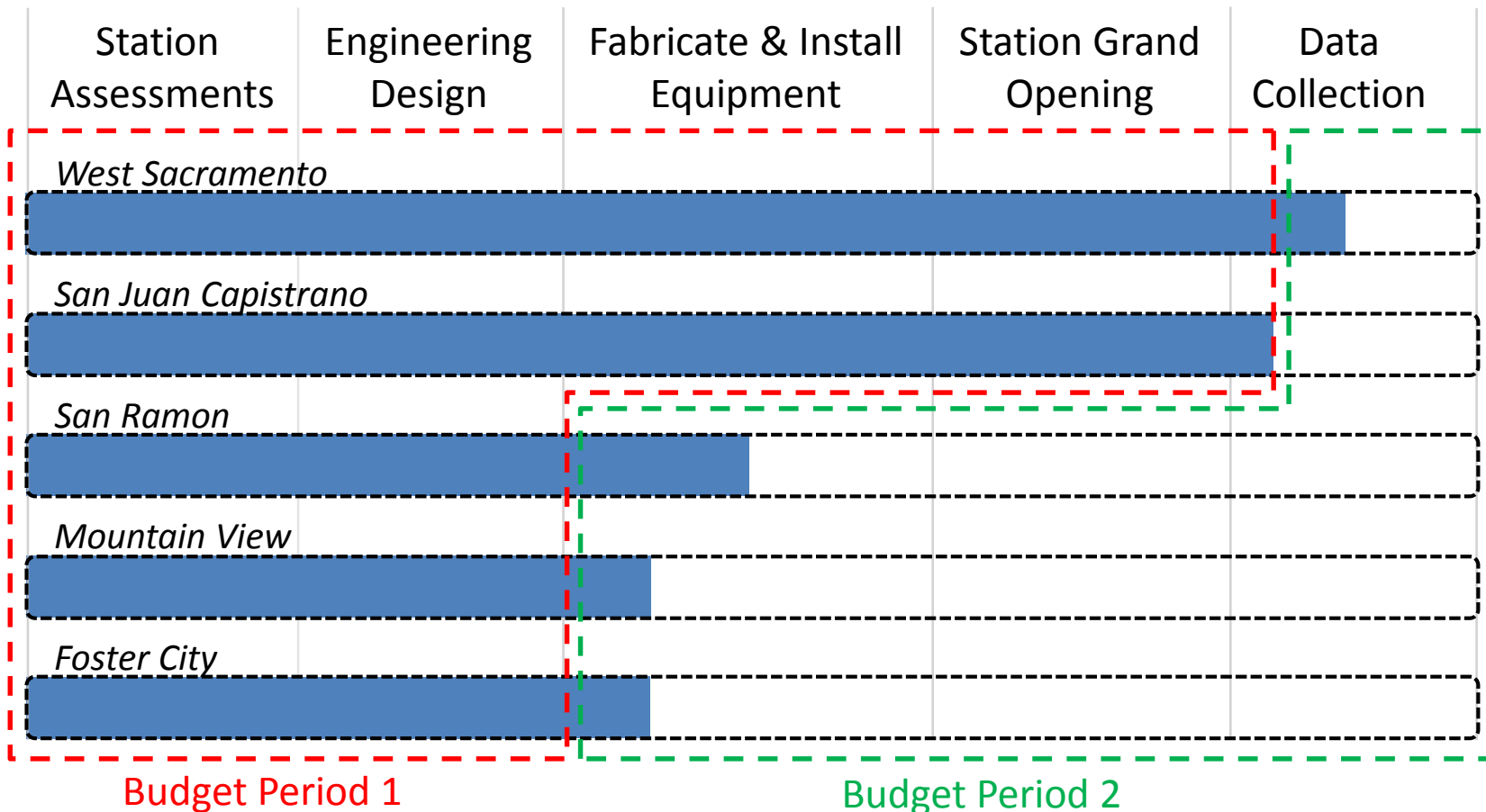

Accomplishments and Progress

Successful installation of data acquisition system at West Sacramento

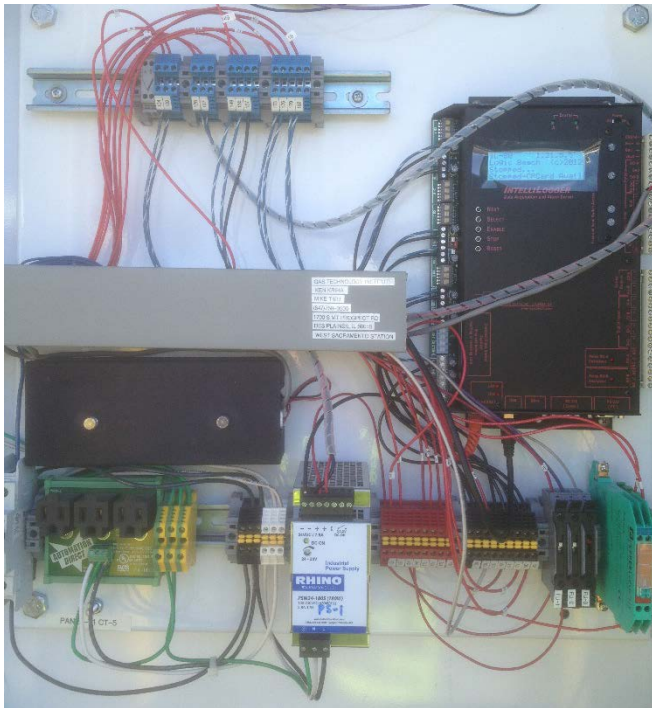

GTI Data Panel Installed at Site

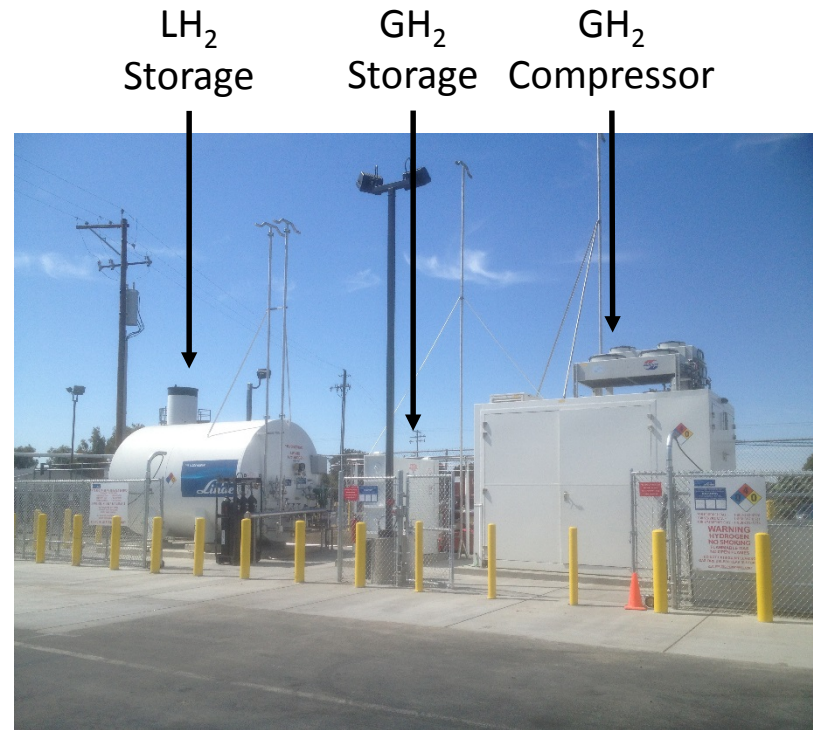

Linde Hydrogen Storage and Compression Equipment at West Sacramento

Accomplishments and Progress

Successful installation of data acquisition system at San Juan Capistrano

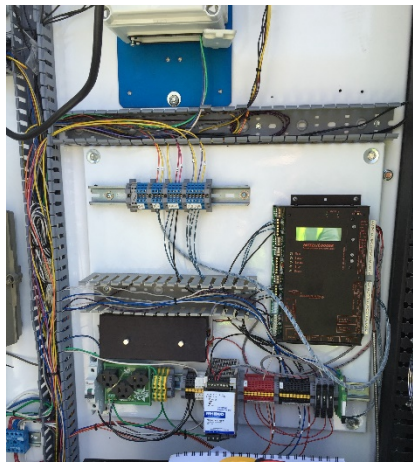

GTI Data Panel
Installed at Site



Linde Dispenser



LH₂ Storage GH₂ Compressor

Linde Storage and Compression Equipment at
San Juan Capistrano

Accomplishments and Progress

- > Data collection ongoing for active sites
 - West Sacramento: 5 quarters of data reported to NREL
 - San Juan Capistrano: 2 quarters of data reported to NREL
- > Permitting process nearing completion for San Ramon site. Construction should begin in mid-2016.
 - Station equipment and Data acquisition system for San Ramon built and awaiting installation
- > Remaining 2 sites are progressing. Equipment has been fabricated. Construction dates will depend on permitting.

Accomplishments and Progress

Data collection underway for West Sacramento and San Juan Capistrano

West Sacramento

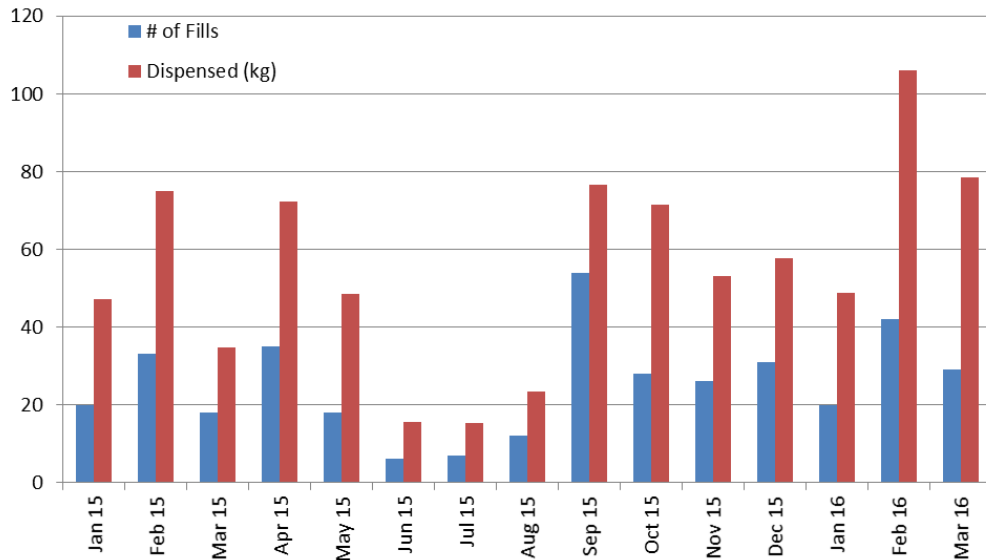

San Juan Capistrano

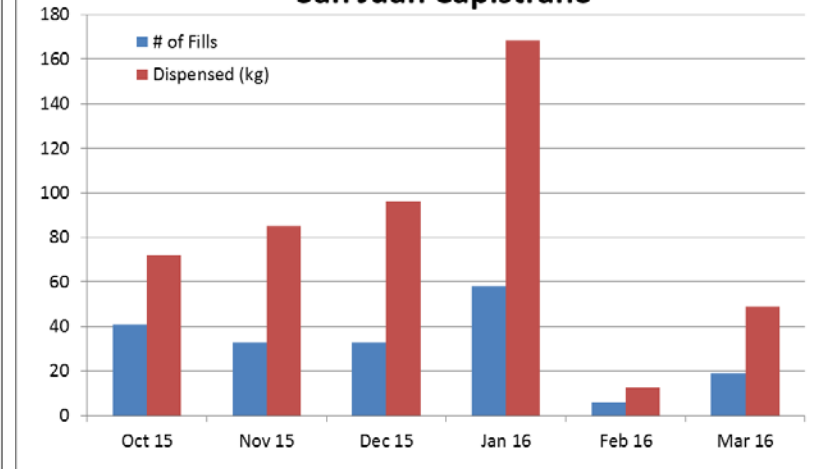

Responses to Previous Year Reviewers' Comments

Reviewer Comment	Response
1. Project team needs to focus on keeping the last three stations on schedule.	<ul style="list-style-type: none">• Linde is working intensively on addressing permitting and siting issues for the remaining three stations. Unfortunately despite best efforts, this process is very slow in some locations.
2. Project partners should produce a report documenting lessons learned in hydrogen station permitting.	<ul style="list-style-type: none">• There is an industry-wide effort to support this goal. For example, the Governors office in CA recently published the 'Hydrogen Station Permitting Guidebook'.
3. Perhaps data could be collected on liquid hydrogen boil-off rates.	<ul style="list-style-type: none">• NREL worksheets include data on the hydrogen storage and use that can be utilized to perform a station mass balance. Boil-off rates are most significant when utilization is low.

Collaborations



Project Team:

Gas Technology Institute (Prime) –

- Non-profit, R&D laboratory, 300+ employees
- 350 active projects; several current DOE and hydrogen projects
- BKi, recently acquired by GTI, operates the California Fuel Cell Partnership (CaFCP)



Linde, LLC (Subcontractor) –

- Technology innovator for H₂ fueling equipment
 - Ionic compressor/cryo-pump
- Several operational hydrogen fueling stations

Collaborations

Team Member	Roles
GTI	Oversees and manages the project; designs, builds, and installs data collection system; processes data and reports to NREL; maintains data collection unit throughout performance period.
Linde	Technical advisor and Coordinator of site design information; coordinates site utilities, communications, and power for data collection effort, submits transactional, utility, safety, and operations data to GTI, maintains the station throughout performance period.

Remaining Challenges and Barriers

- Data Panel Failures
 - Throughout the first year, data panels were losing ability to transmit data to GTI.
 - This was traced to an interference with the Linde network and resolved by installing a dedicated cell modem to transmit the data and bypass the network.
- Delays in commissioning stations has changed the schedule for this project. Linde is working diligently to commission stations and working with CA and industry to improve system.

Technology Transfer Activities

- General data acquisition panel design can be used for other stations as well
 - If a single data panel design is to be used for several station configurations it will require significant design changes
- GTI's lessons learned in system development, network communications, and commissioning would be valuable to new installations

Proposed Future Work

- Continue data collection activities for 2 sites and report to NREL.
- Install instrumentation and electrical panel at San Ramon site.
- Installation at remaining 2 station sites once construction begins.



Summary

Relevance: GTI aims to compile, analyze, and submit pertinent data to meet technology validation objectives and goals set forth by the Fuel Cell Technologies Program through its multi-year research, development, and demonstration plan.

Approach: Develop, integrate, and maintain non-intrusive data collection systems to produce meaningful observations and data collection for the NFACTEC.

Accomplishments this period: Instrumentation has been installed at 2 sites. Data has been collected and submitted to NREL. Data acquisition panel built and prepared for installation at the next site.

Summary

Collaborations: Project team and structure have been assembled. Key team members from both organizations have been identified and roles have been defined, and are working together well.

Future Work: Continue to conduct data collection activities for the West Sacramento and San Juan Capistrano sites and report to NREL. Install instrumentation and electrical panel at Ramon site in mid 2016. Installation at Foster City and Mountain View sites in Q4 2016.