



# High Efficiency PEM Water Electrolysis Enabled by Advanced Catalysts, Membranes and Processes

**PI: Dr. Katherine Ayers**  
**Nel Hydrogen**  
**April 30, 2019**

Project ID #  
P155

This presentation does not contain any proprietary, confidential, or otherwise restricted information



# Project Overview

## High Efficiency PEM Water Electrolysis Enabled by Advanced Catalysts, Membranes and Processes

Kathy Ayers, Proton OnSite

Iryna Zenyuk, National Fuel Cell Research Center (NFCRC) at UC Irvine

Karren More, ORNL

## Project Vision

We are solving the cost barriers for PEM electrolysis by integrating advanced cell designs, materials and fundamental characterization of performance

## Project Impact

The anticipated impact of Phase II is to incorporate all elements of the advanced membrane, catalyst, electrode fabrication techniques, and cell modeling into a reliable MEA configuration with efficiency meeting the 43 kWh/kg targets

Award #	EE0008081
Start Date	9/1/2017
Project End Date	8/31/2020
Year 1 Funding*	\$298,690
Year 2 Funding*	\$412,712

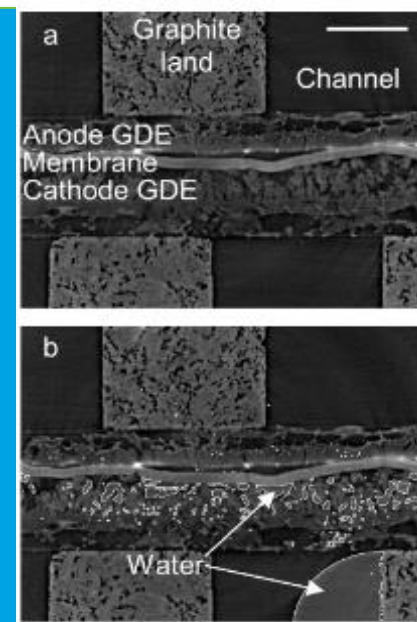

Example of tomography and colored liquid water image

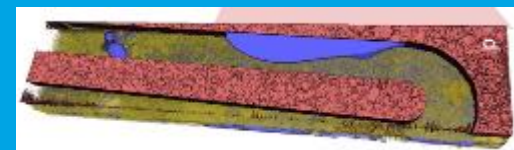



# Approach - Summary

## Project history

Thinner membranes and alternate catalysts have shown promise for stable operation of PEM electrolyzers at improved efficiency. This project advances material performance and integrates components together, while leveraging fundamental characterization to understand and push design limits.

## Barriers

- Long term durability: understand degradation through accelerated tests and fundamental characterization
- Higher defect sensitivity with adv. materials and operation: refine cell design and characterize in situ

## Proposed targets

Metric	State of the Art	Proposed
Membrane thickness	175 microns	50 microns
Operating temperature	58°C	80-90°C
Cell Efficiency	53 kWh/kg	43 kWh/kg

## Partnerships

**Iryna Zenyuk, NFCRC:** In situ tomography to characterize CLs, PTLs, and water distribution

**Karren More, ORNL:** TEM of platinum group metal migration



# Approach - Innovation

- PEM electrolysis has potential for significant efficiency improvement
  - Challenge is interfaces and integration, where complex interactions exist
- Project takes holistic view of problem including interaction with EMN nodes
  - Understand catalyst dissolution mechanisms at low loading
  - Impact of membrane hydration on processing/strength
  - Porous substrates and coatings
  - Impact of fabrication methods and formulas on performance

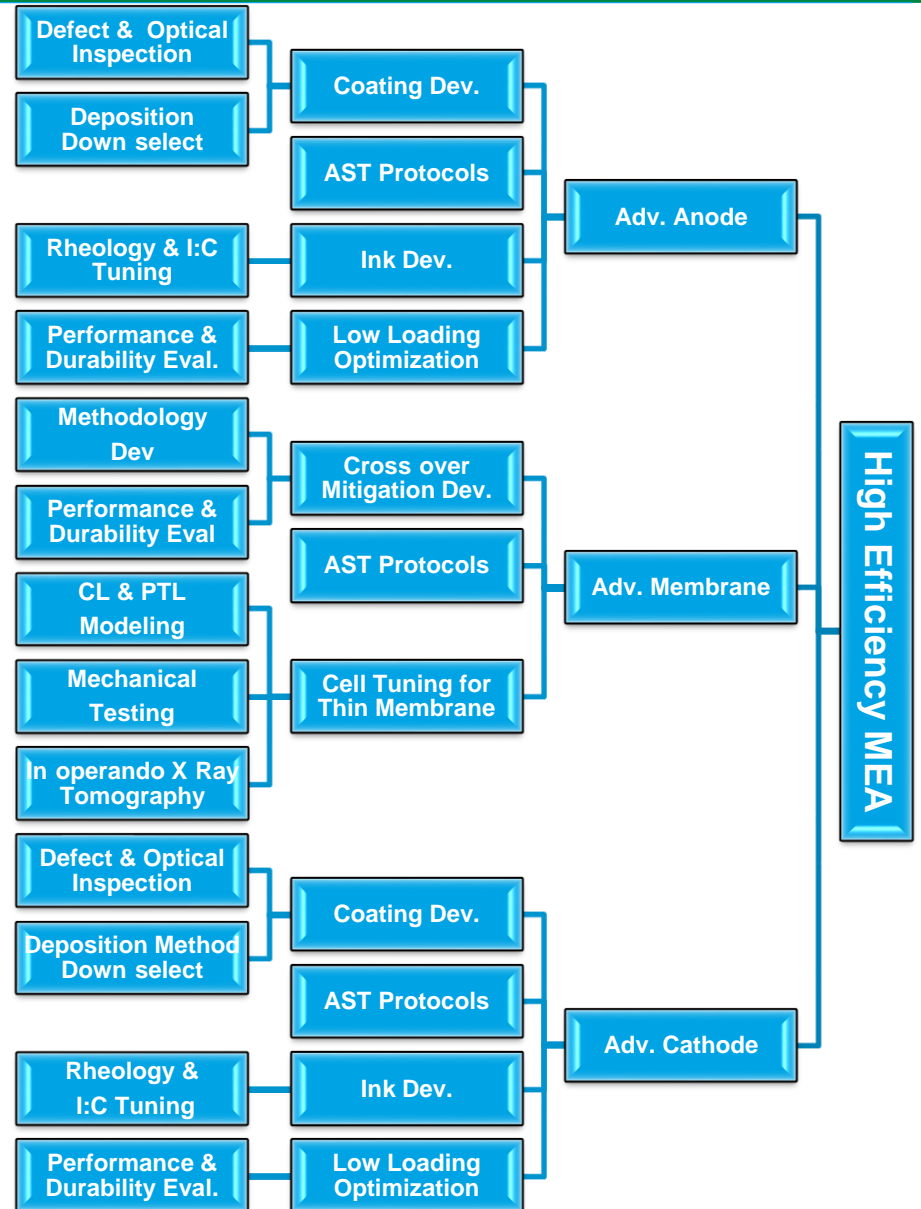



# Relevance & Impact

- PEM electrolyzers have significant development opportunities for increased electrical efficiency, without sacrifice in durability, through:
  - Integration of membranes  $\leq 50 \mu\text{m}$  thick and capable of 80-90 °C operation, while controlling mechanical creep and gas crossover
  - Reducing the catalyst loading to at least  $1/10^{\text{th}}$  on both electrodes, while controlling water distribution and the porous transport layer/catalyst interface
  - Synthesis of higher activity OER catalysts and refinement of electrode fabrication processes
  - Integration of the above advancements into a full assembly
- Supporting National Labs and subcontractors assist in characterizing materials and process modification
  - Material characterization, in-operando analysis, and advanced modeling of membrane and PTL interactions
- Final deliverable of the project will be an advanced electrolysis stack producing  $\text{H}_2$  at 43 kWh/kg and at costs of \$2/kg  $\text{H}_2$



# Relevance and Impact

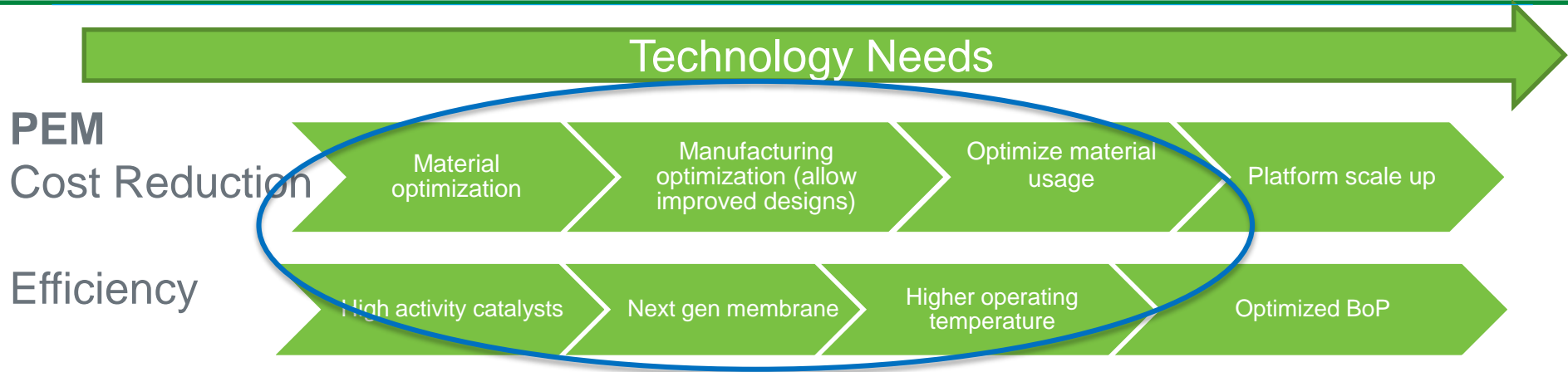

- Electrolysis demand projected to rapidly expand: have to continue to innovate to maintain cost competitive position in the US
  - Large players entering the market: Siemens, ThyssenKrupp, Asahi Kasei
- Alkaline technology likely address much of 2020-2030 MW demand due to proven scale
- PEM likely to substantially ramp ~2025 forward
- New technologies (solid oxide, anion exchange membrane) not mature enough to penetrate large scale markets till >2030
  - Impact of other water splitting technologies even longer term

## Notional product mix evolution

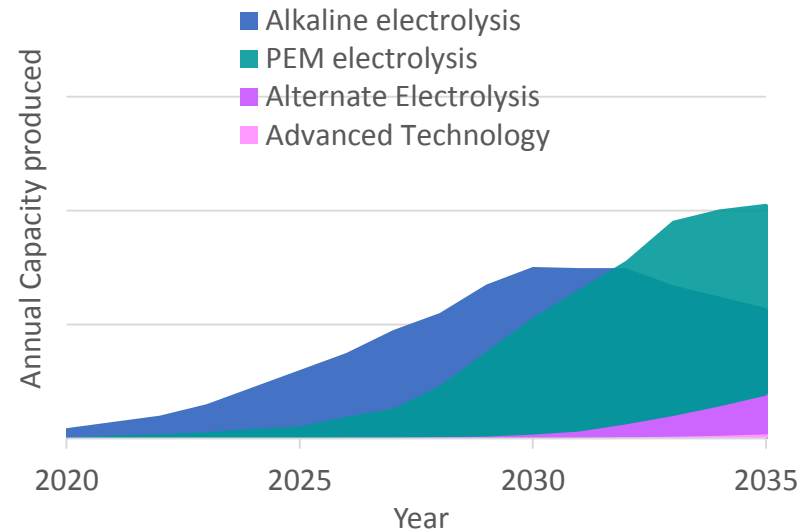



# Accomplishments: Budget Period 2 Quarterly Milestones

BP 2 (12 months) Milestones	Quarter	Completion
Understand impact of membrane hydration conditions on electrode performance	1	100%
In-operando electrolysis cell is operational and two best of the class MEAs are characterized under two current densities	3	25%

**\* Q4 milestone success is required to meet project targets of \$2/kg H<sub>2</sub>**



# Accomplishments to Date - Membrane

- Samples hydrated at varying temperature to determine impact on swelling
- Compared long (254 and 177  $\mu\text{m}$ ) and short (90 and 50  $\mu\text{m}$ ) chain PFSA
- Short-chain PFSA showed least change across temperature range
  - Implies improved dimensional stability and mechanical integrity

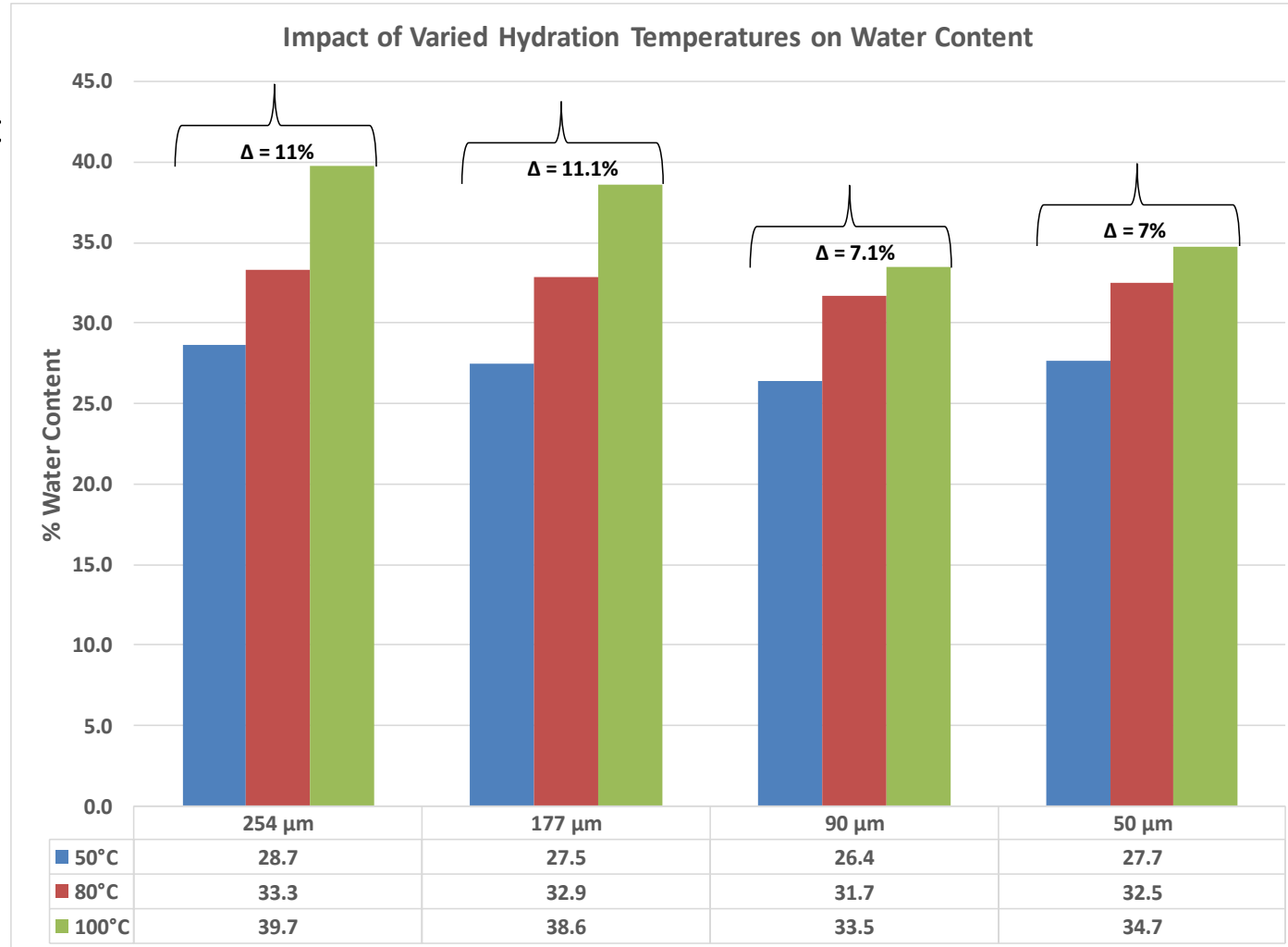

\*PFSA = polyfluorosulfonic acid





# Accomplishments to Date – Membrane

- Polarization data performance tracks with decreasing thickness as expected
- Results for same membrane are within error; no consistent trend with hydration temperature
  - Higher water uptake provides no benefit
- Mechanical testing planned to assess hydration state influence on mechanical strength

Polarization Data for Membrane Samples - Post Hydration  
25 cm<sup>2</sup> | 50°C

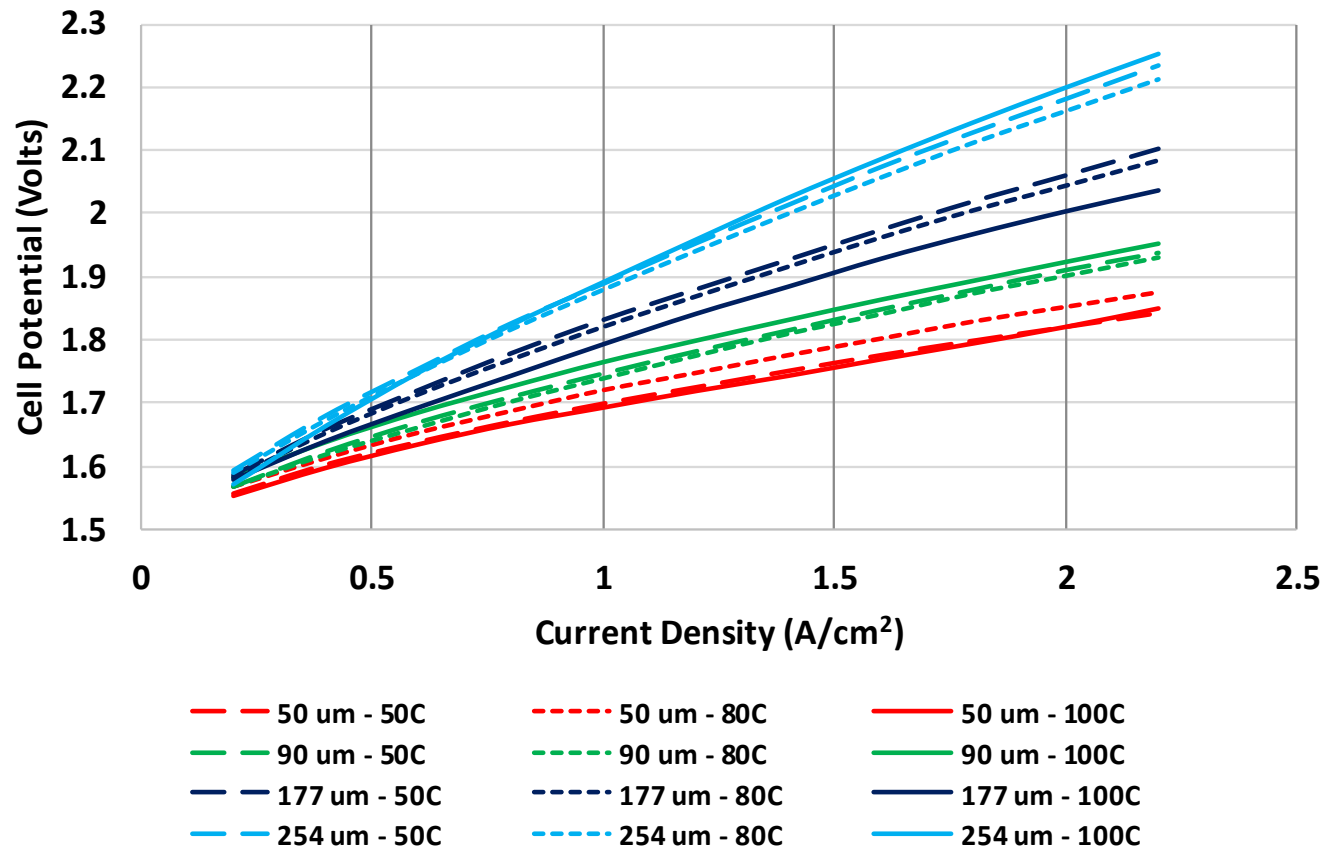



# Accomplishments to Date – Membrane



- Initial mechanical testing showed rapid compression resulted in more membrane stress
  - Less time for polymer chains to rearrange
  - Limited capability for long term testing at relevant temperatures/hydration
- Fixture being developed at LBL will enable:
  - Creep studies of membrane at temperature
  - In presence of water
- Status of long-term creep study
  - Heating controller completed
  - Thermocouples received
  - New stage design - drawing ready
  - Machining in process

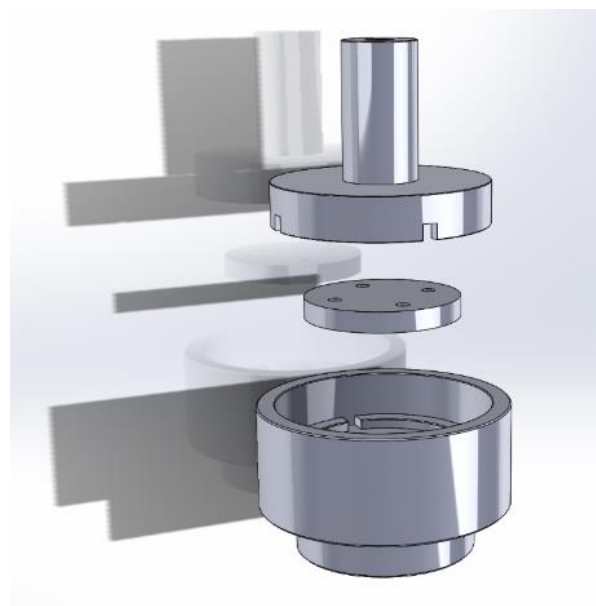
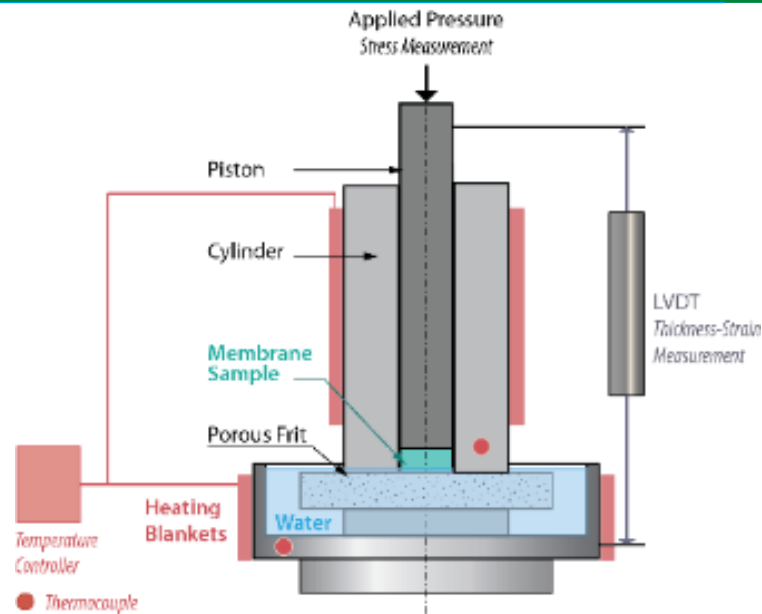



# Accomplishments to Date Advanced Catalysts – Coatings

Increasing ionomer coverage and saturation of free surface of particles

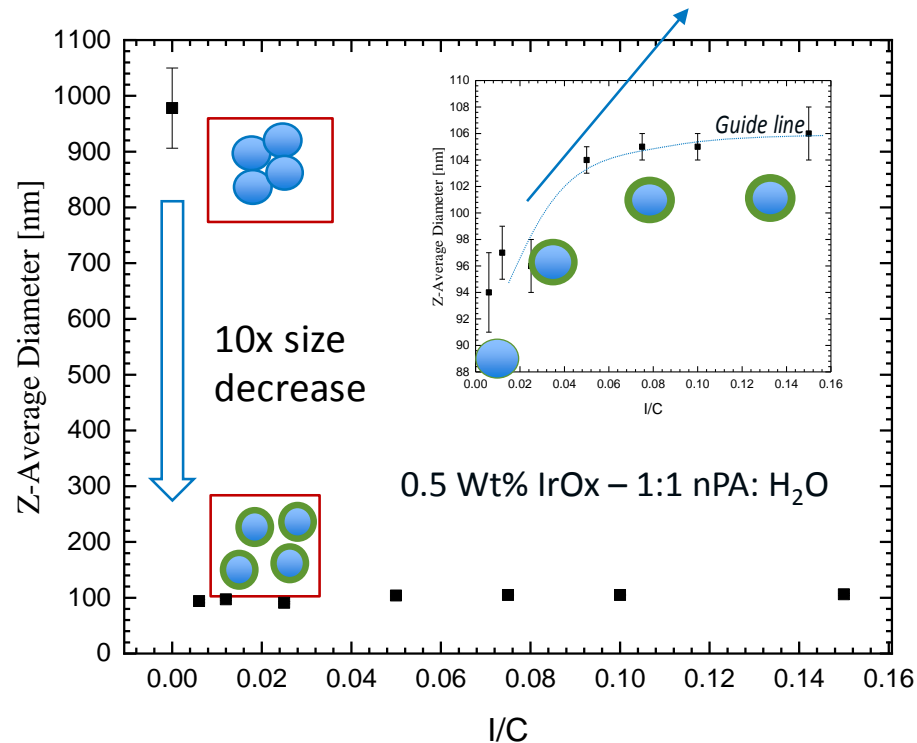
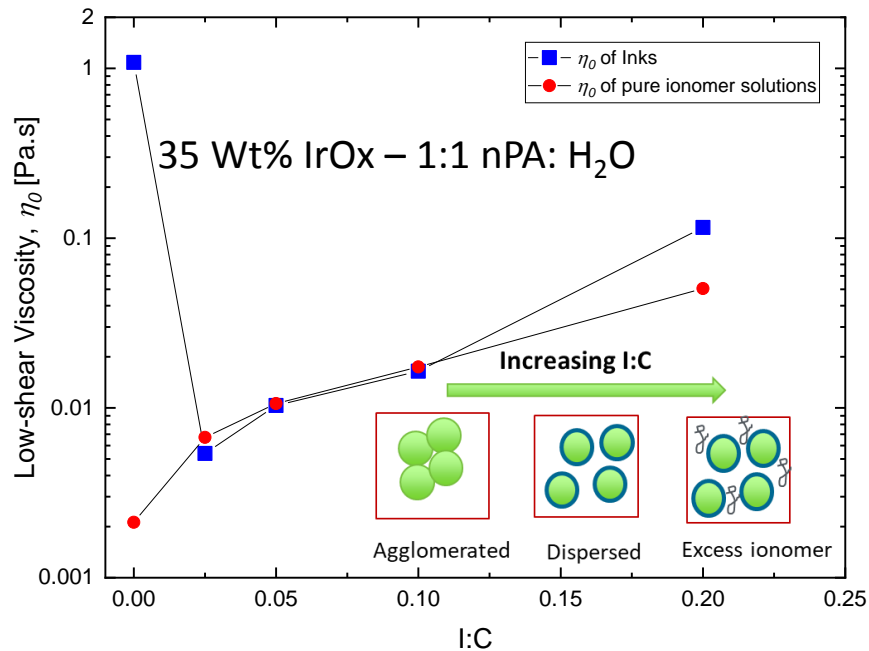

- Particles agglomerate with no ionomer (I:C = ionomer catalyst ratio; blue dot upper left)
- Dynamic light scattering shows I:C as low as 0.006 reduces agglomerate size (right chart)
- Ionomer helps disperse particles at I:C as low as 0.025; at I:C > 0.025, excess ionomer increases viscosity (left); coverage increases until 0.05 I:C (right) then levels out
- Suggests I:C = 0.05 is sufficient, but also need to consider impact on electrode properties



# Accomplishments to Date Advanced Catalysts – Coatings

- Development of a catalyst ink for the OER oxide catalysts has recently transitioned to PTE deposition
  - High porosity of PTL has been major challenge
    - Deposition process and management of viscosity has been majority of effort
  - Has produced reasonably uniform coatings, though the rods available cannot coat low enough loadings
    - New rods on order
    - Samples being prepared for test at Proton with baseline loadings

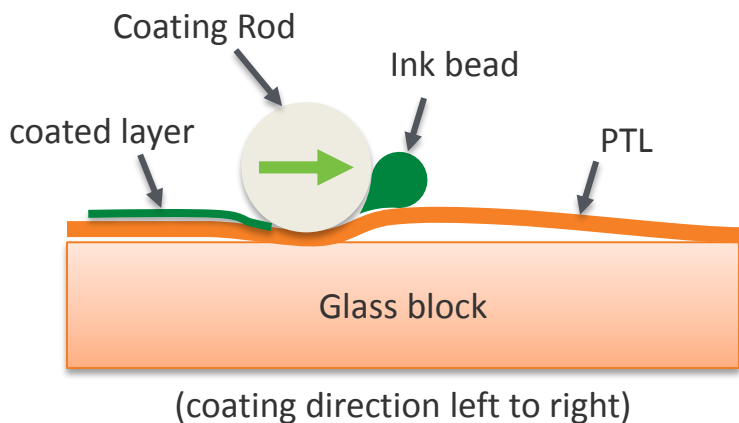

#25 Meyer rod coated sample. Left: top coated side. Right: bottom side – no bleed through. Inconsistencies in color due to substrate inconsistencies.



# Accomplishments to Date Interface Characterization: PTE vs. CCM



Imaging shows differences in catalyst distribution by electrode configuration → impact on cell performance

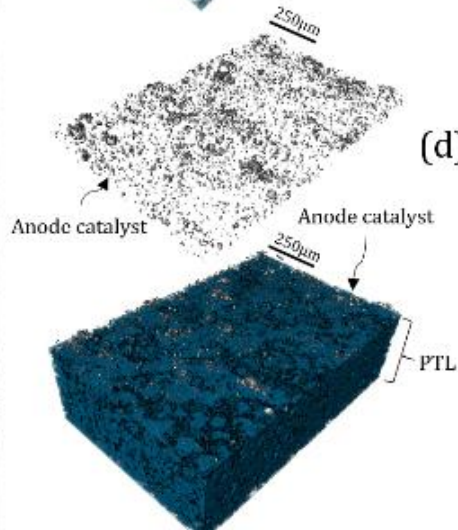
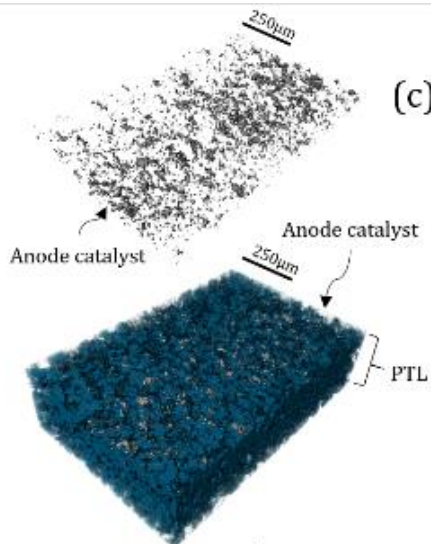
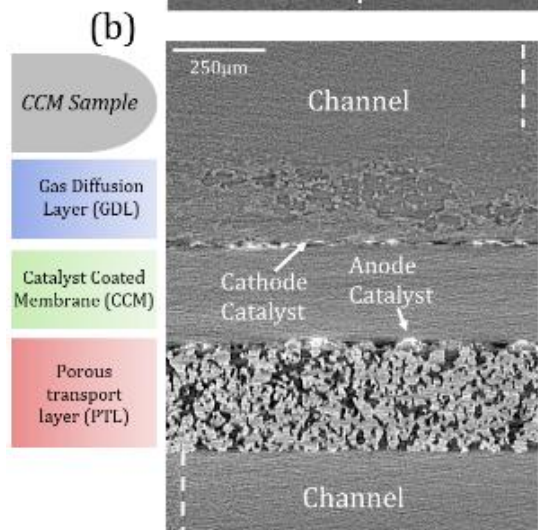
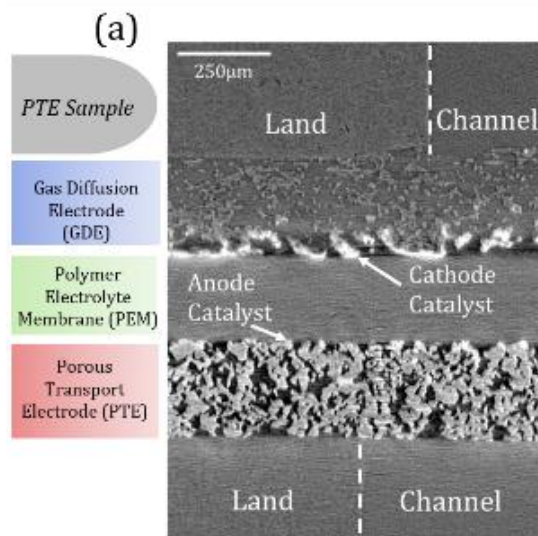

PTE shows less uniform layer and poorer performance

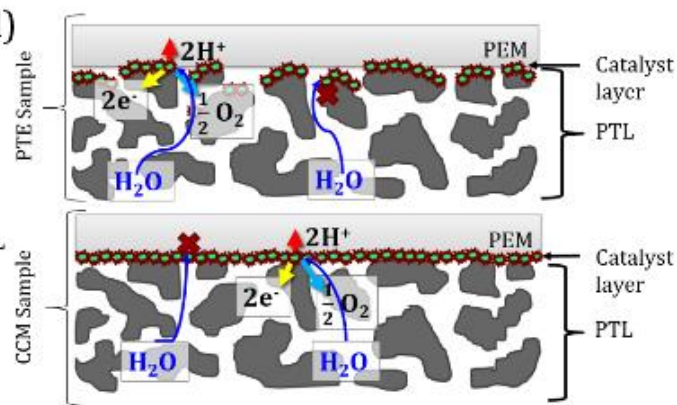
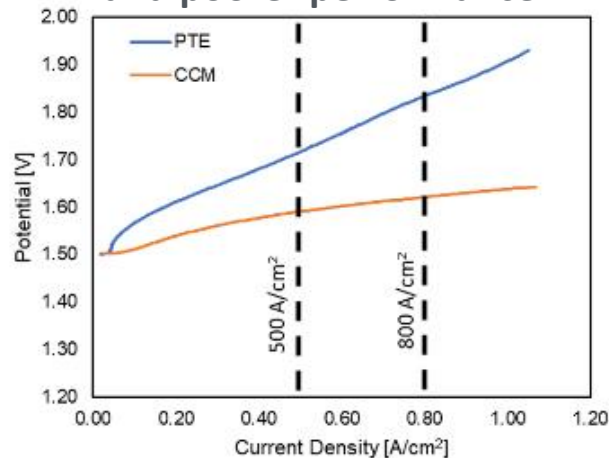



# Accomplishments to Date PTL Morphology

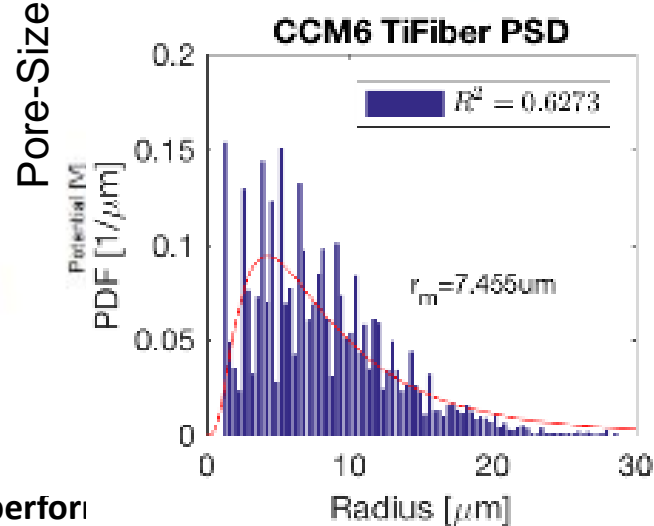
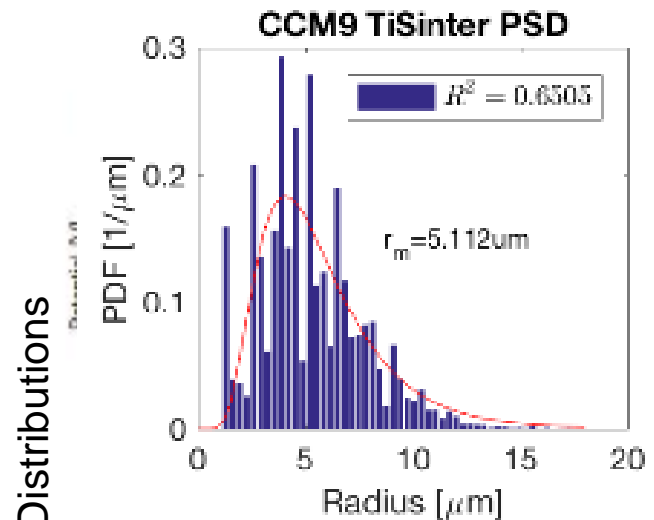
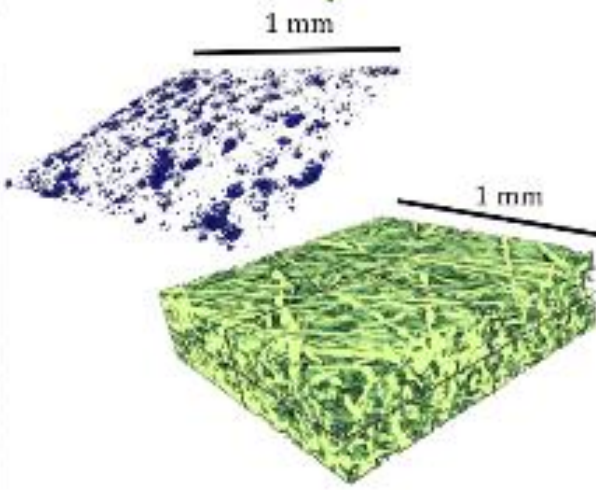
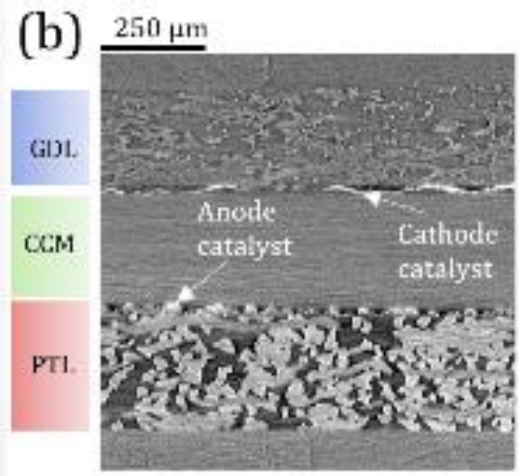
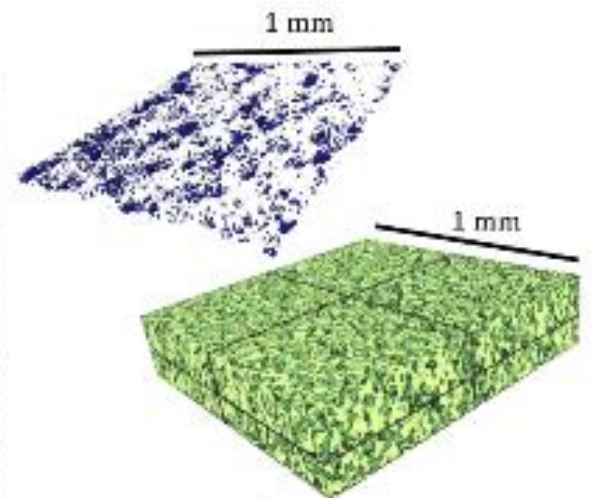
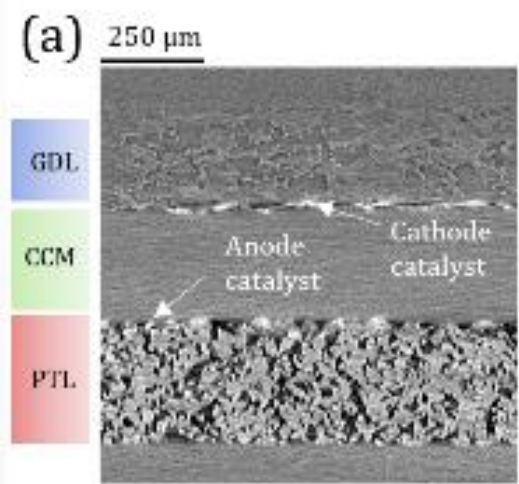

Pore-Size Distributions

- Data is being collected to understand flow distributions and impact on performance
  - Also being used to understand differences in catalyst contact between PTL construction
  - Feeds into multi-physics model at LBNL



# Accomplishments to Date Cell Modeling



## 2D computational domain

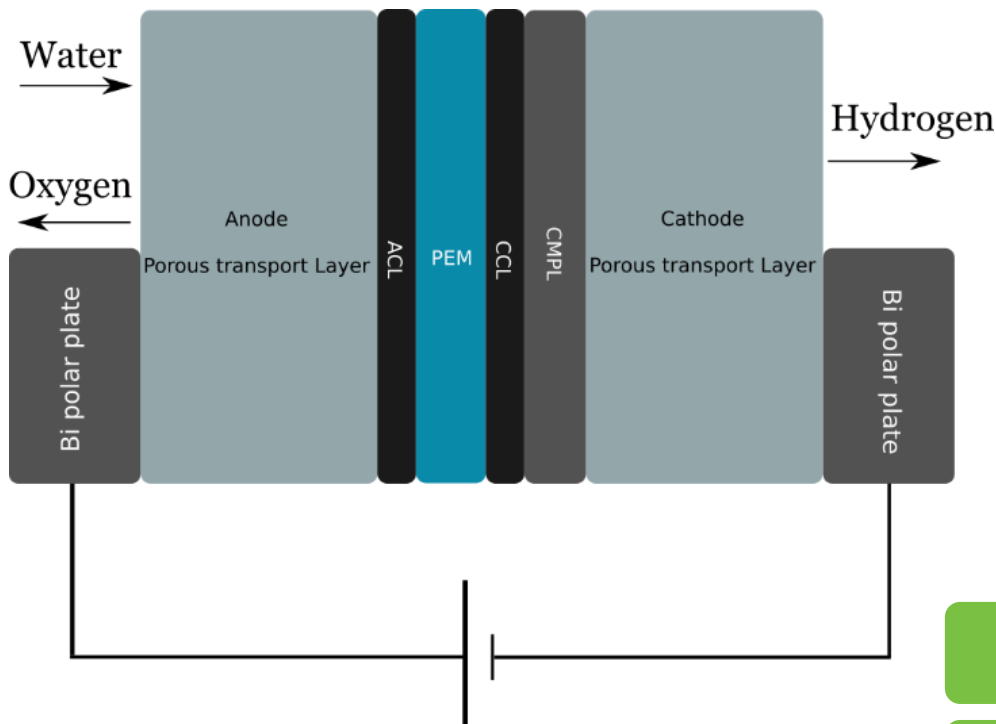

**Multi-physics description:  
examples of effects considered**

## Model validation with experimental data at 80°C

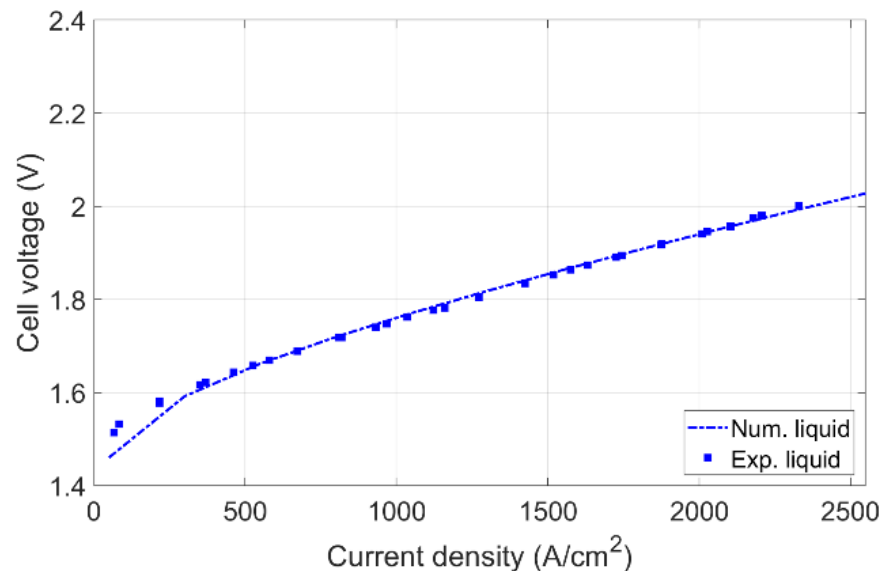

**Gas transport**

• Convection

**Electron transport**

• Ohm's Law

**Membrane transport**

• Proton transport  
• Membrane water transport

**Cross-over in membrane**

• Hydrogen permeation  
• Oxygen permeation



# Accomplishments to Date

## Cell Modeling



### Contour plots generated to predict performance

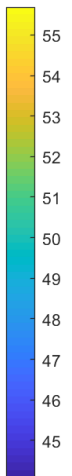
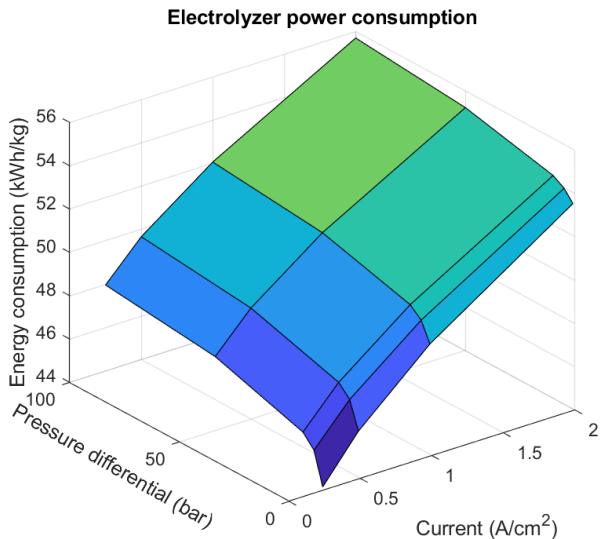

**Energy consumption of electrolyzer and system efficiency (including Faradaic)**

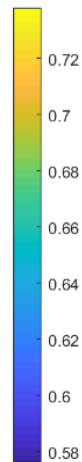
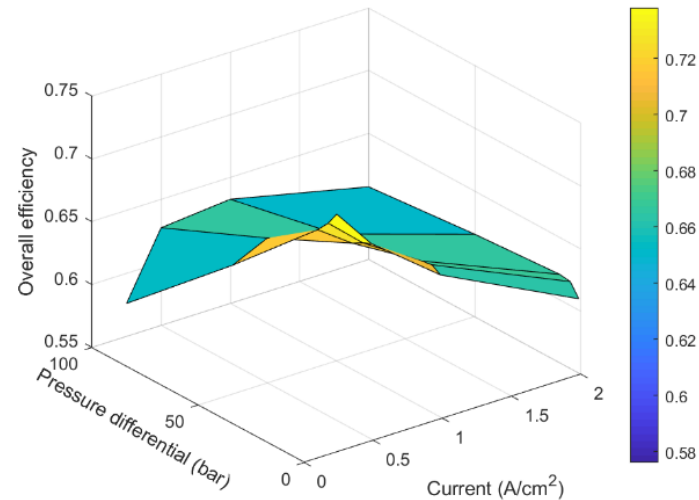

**Cell performance at 2.0 (A/cm<sup>2</sup>)**

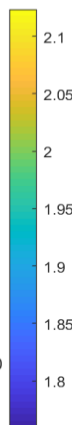
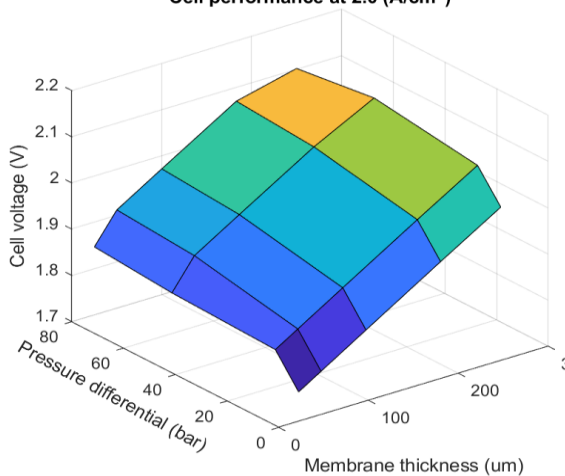

**Membrane thickness optimization**

**Cell performance at 2.0 (A/cm<sup>2</sup>)**

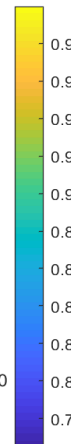
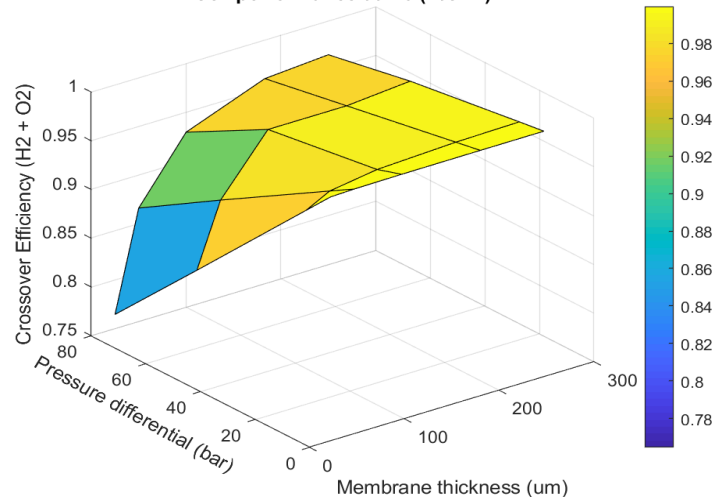



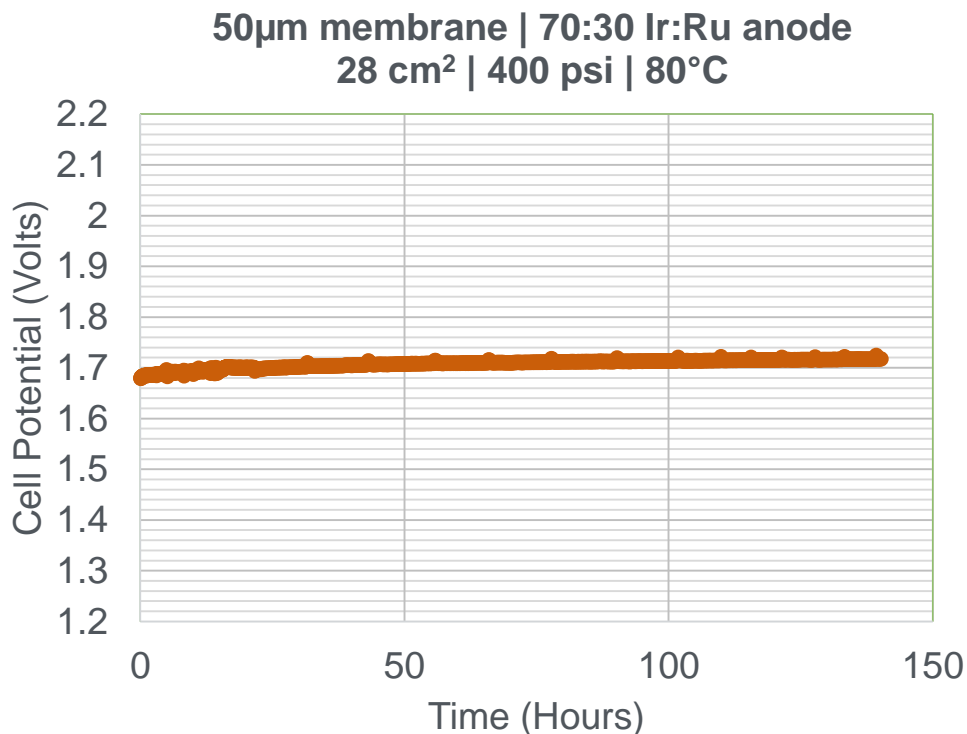
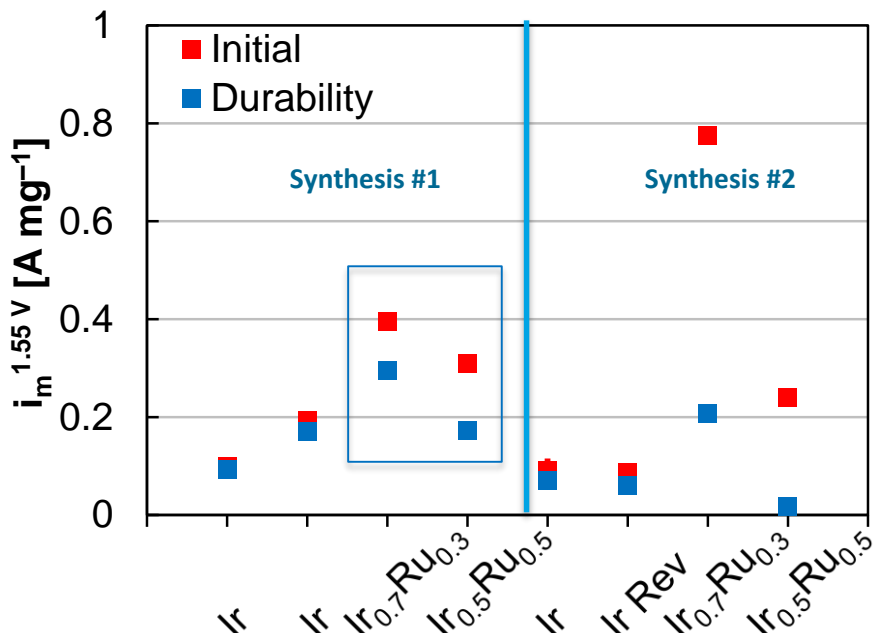

- Activities at 1.55 V; durability following 2.0 V hold, 13.5 h
- Dissolution relatively low (oxides), Less Ru dissolution than expected
- Durability testing of 50  $\mu m$  membrane conducted with input from previous studies
- Used Ir<sub>0.7</sub>Ru<sub>0.3</sub> OER catalyst processed at Proton for extended stability test
- After initial uptick in potential, curve begins to flatten



# Collaboration: Effectiveness

- Active engagement between contract partners and nodes has been consistent
  - Information routinely exchanged between team members has shaped test plans
  - Targeted at industry requirement for cost reductions resulting from CapEx and OpEx improvements
- Modeling and characterization efforts are being used to narrow test conditions and material selection for greater program efficiency



# Proposed Future Work

## **LBL**: Initiation of Creep (long-term strain hold)

- Evaluation of membrane hydration state, thickness, and temperature to look at membrane responses under load
- Incorporate microscale features including catalyst connectivity
- Study bubble formation effect on current density redistribution

## **NREL**: Deposit low loaded inks as PTEs and provide to Proton for test

## **NRCFC**: Evaluate oxygen evolution using X-ray radiography

- Testing at current densities of 1 A/cm<sup>2</sup> and 2 A/cm<sup>2</sup>
- Varied flow-rates for measurement of oxygen removal rates
- Vary the PTL configuration in combination with CCM vs PTE comparisons

## **ORNL**: Complete analysis of operated samples to look for catalyst migration within electrodes and membrane

## **Proton**: Tune cell design based on input from modeling and characterization

- Conduct operational tests of screened catalysts and components received from NREL for down-select based on efficiency/durability

Any proposed future work is subject to change based on funding levels



# Project Summary

- Progress has been made understanding the rheology and ink interactions with oxide based catalysts
  - Initial electrodes have been deposited based on these findings and are being prepared for functional verification
- X-Ray tomography studies have shown interactions between PTEs and CCM and catalyst utilization
  - Understanding of bubble formation and impact on current distribution is on-going
  - Results are being shared with LBNL for model creation
- Creep studies planned and will provide input for cell design and material management over life of system
- Steady-state testing is on-going with progress made towards 500 hrs at 1.7V