

# Hydrogen Storage Cost Analysis



Cassidy Houchins

Brian D. James

June 2022

Project ID: ST235

Award No. DE-EE0009630

DOE Hydrogen Program

2022 Annual Merit Review and Peer Evaluation Meeting

This presentation does not contain any proprietary, confidential, or otherwise restricted information

# Overview

<b>Timeline</b> Project Start Date: 9/30/21 Project End Date: 9/29/24 % complete: ~17% (in year 1 of 3)	<b>Barriers</b> A: System Weight and Volume B: System Cost K: System Life-Cycle Assessment
<b>Budget</b> Total Project Budget: \$699,964 Total DOE Funds Spent: ~\$16,200 (through March 2022 , excluding Labs)	<b>Partners</b> Pacific Northwest National Laboratory (PNNL) Argonne National Lab (ANL)

# Project Goal

- Conduct rigorous, independent, and transparent, bottoms-up techno-economic analysis of H<sub>2</sub> storage systems using Design for Manufacture and Assembly (DFMA)
- Identify cost drivers and recommend to DOE the technical areas needing improvement for each technology.
- Provide DOE and the research community with referenceable reports on the current status and future projected costs of H<sub>2</sub> storage systems
- Analyses conducted in 2021
  - Onboard liquid (LH<sub>2</sub>) and compressed (700 bar Type 4) H<sub>2</sub> storage systems for Class 8 Long Haul trucks
  - Bulk (3,800 kg) LH<sub>2</sub> storage systems at refueling station

# Relevance and Impact

- DFMA<sup>®</sup> analysis is used to predict costs based on both mature and nascent components and manufacturing processes depending on what manufacturing processes and materials are hypothesized.
- Identify the cost impact of material and manufacturing advances and to identify areas of R&D with the greatest potential to achieve cost targets.
- Provide insight into which components are critical to reducing the costs of onboard H<sub>2</sub> storage and to meeting DOE cost targets

# Approach: DFMA<sup>®</sup> methodology used to track annual cost impact of technology advances

- DFMA<sup>®</sup> (Design for Manufacture & Assembly) is a process-based, bottoms-up cost analysis methodology which projects material and manufacturing cost of the complete system by modeling specific manufacturing steps.
- Registered trademark of Boothroyd-Dewhurst, Inc.
- Basis of Ford Motor Company (Ford) design/costing method for the past 20+ years
- Predicts the actual cost of components or systems based on a hypothesized design and set of manufacturing & assembly steps
- Determines the lowest cost design and manufacturing processes through repeated application of the DFMA<sup>®</sup> methodology on multiple design/manufacturing potential pathways.

$$\text{Estimated Cost} = (\text{Material Cost} + \text{Processing Cost} + \text{Assembly Cost}) \times \text{Markup Factor}$$

## Manufacturing Cost Factors:

1. Material Costs
2. Manufacturing Method
3. Machine Rate
4. Tooling Amortization

### Methodology reflects cost of under-utilization:

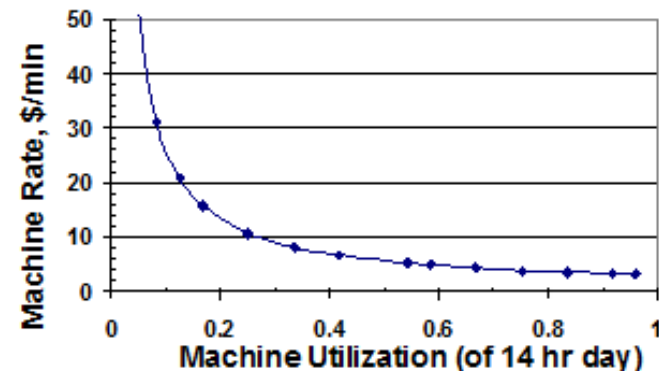

### Methodology Reflects Cost of Under-utilization:

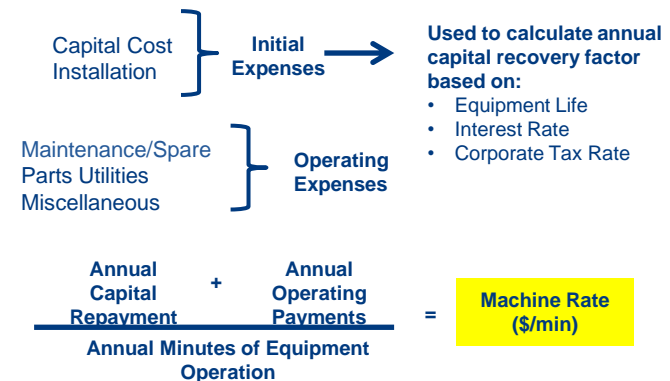

# Class 8 Long Haul Truck Onboard Storage System Overview

The baseline storage system is frame mounted 700 bar Type 4

Property	Value	Note
Storage System	Type IV	T700S/epoxy, PA6 liner, aluminum boss
Tank / Total Capacity (kg)	30 / 60	Target definition*
Tanks per System	2	Tanks of identical size
External Package Dimensions	250 cm x 64 cm	Assumption. Similar to Quantum Fuel Systems.
Mounting	Strap-Mounting Frame	Assumption. Similar to Quantum Fuel Systems.
BOP	Integrated valve and regulator	Similar to GFI ITVR-70. Cost is assumed to be 120% of LDV unit cost per guidance from GFI.
Estimated Composite Mass (kg/tank)	444	Estimated using performance derived from ANL analysis
Estimated Total Mass (kg <sub>H<sub>2</sub>storage</sub> /truck)	1100	Compared to 750 kg for Quantum 46 DGE CNG System.
Safety Factor	2.25 (nom)/2.54 (eff)	NGV2, fiber, and mfg. variations
Projected Cost (\$/kgH <sub>2</sub> )	383	Projected to 100k systems per year. Compared with 2030 target of \$300/kgH <sub>2</sub> *

- Baseline system is currently projected to able to meet DOE targets
- Pathways to 2030 (\$300/kgH<sub>2</sub>) and the ultimate target (\$266/kgH<sub>2</sub>) requires 40% carbon fiber cost and weight reduction from relaxed safety factor
- Alternatives to compressed gaseous H<sub>2</sub> are described in the following slides and compared with the baseline

\* [https://www.hydrogen.energy.gov/pdfs/19006\\_hydrogen\\_class8\\_long\\_haul\\_truck\\_targets.pdf](https://www.hydrogen.energy.gov/pdfs/19006_hydrogen_class8_long_haul_truck_targets.pdf)

# 700 bar Type 4 Storage Cost Breakdown

Meeting DOE targets will require breakthrough in carbon fiber costs for compressed gas storage

Projected cost breakdown at 100k systems per year for frame rail mounted 60 kgH<sub>2</sub> (available) 700 bar Type 4 storage system for Class 8 long haul trucks

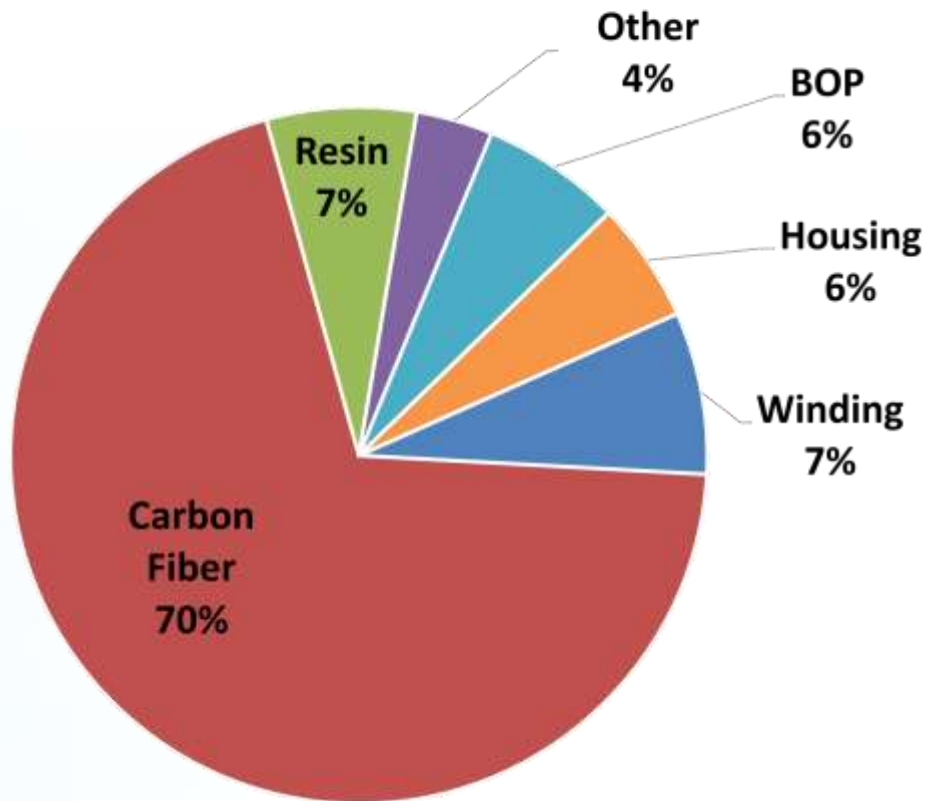

Potential cost reductions for 60 kgH<sub>2</sub> (available) two-tank frame rail mounted 700 bar Type 4 storage system

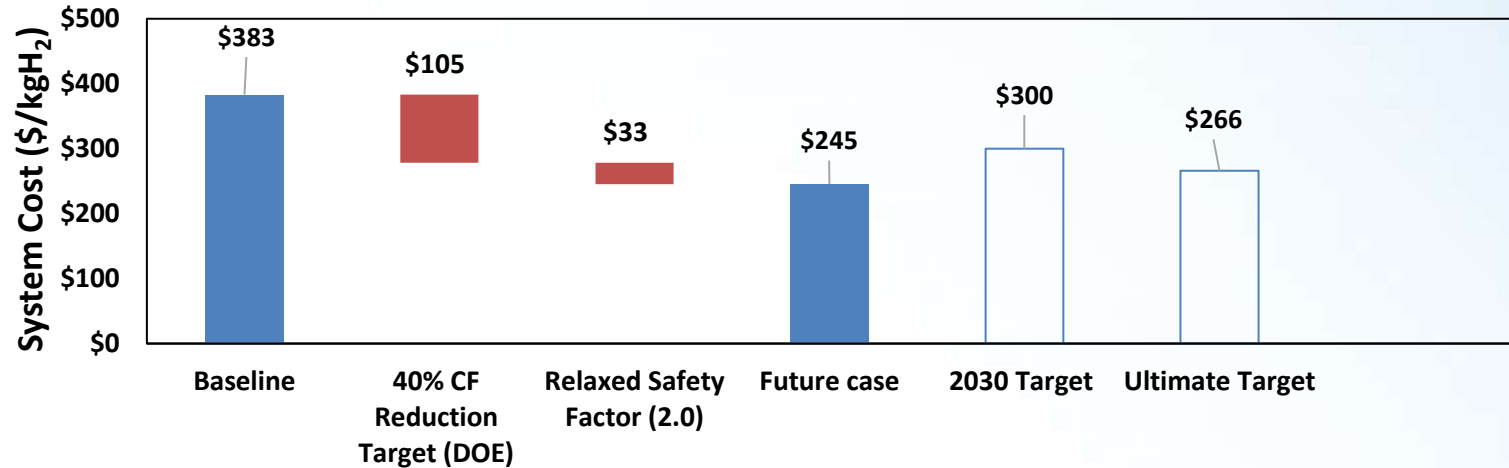

- This cost breakdown has been shared previously with modest process refinements since the 2021 AMR
- There is no path to meeting the DOE targets without addressing carbon fiber price
- The DOE target of reducing carbon fiber price by 40% closes most of the gap between the current cost and 2030 target.
- Relaxing the safety factor from 2.25 to 2.0 reduces weight and cost
- Combined CF cost and weight reduction could achieve ultimate target

# LH2 System Assumptions for a Frame Mounted Class 8 Long Haul Truck Storage System

Storage system design, capacity, and dimensions were provided by ANL (reported in ST223) based on FEA and thermodynamic modeling to predict lightweight, high capacity, low boil off loss vessels

Multi-layer insulation thickness	11 mm MLI	21 mm MLI
Number of tanks	2	2
Shell and wall materials	2219-T87	2219-T87
Onboard pump	1 external	1 external
Usable capacity	50.6 kgH2/tank	48.2 kgH2/tank
Water volume	824 L/tank	770 L/tank
<b>Shell</b>		
Outer diameter	66 cm	66 cm
Length	305 cm	305 cm
Cylinder wall thickness	5.8 mm	5.8 mm
Dome wall thickness	2.85 mm	2.85 mm
Mass	99.4 kg	99.4 kg
<b>Liner</b>		
Outer diameter	62 cm	60.2 cm
Length	282 cm	280.5 cm
Cylinder wall thickness	2.7 mm	2.6 mm
Dome wall thickness	4.5 mm	4.5 mm
Mass	46.6 kg	46.6 kg



# Vessel Manufacturing Is Based on Conventional Metal Forming and Joining and Insulation Application

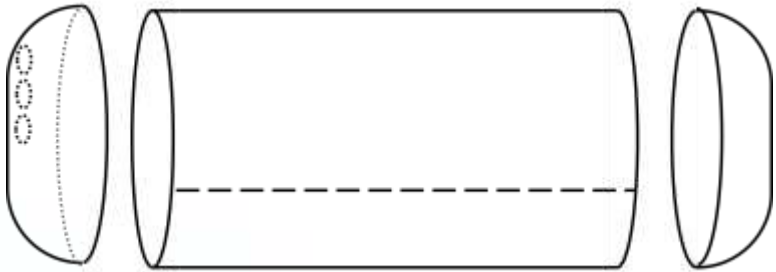

- Liner and shell fabrication assumes a welded three-part construction
- Cylinders are roll formed and welded
- End domes are formed by deep draw and welded to cylinders
- Welding is an automated variable polarity plasma arc (VP-PAW)
- Welds are x-ray inspected
- Finished parts are ultrasonic cleaned for 60 minutes

THE HEROSE 40+40 END SECTIONS...  
ARE SIMPLER AND CLEANER THAN  
BLANKET INSTALLATIONS



- Insulation layup is inspired by Herose (<https://www.herose.co.uk>)
- Cylindrical region layup is automated
- End sections are cut by CNC and manually applied
- Fill, drain, and sensor lines are manually assembled during insulation application
- G10 support structures on the ends are manually applied during insulation layup

# Internal Vessel is End-Supported by G10 Structures

- Support and internal component construction is inspired by Banaszekiewicz (2020)
- Support is assumed to be constructed from G10
  - Improved thermal properties
  - Simple and low cost manufacture

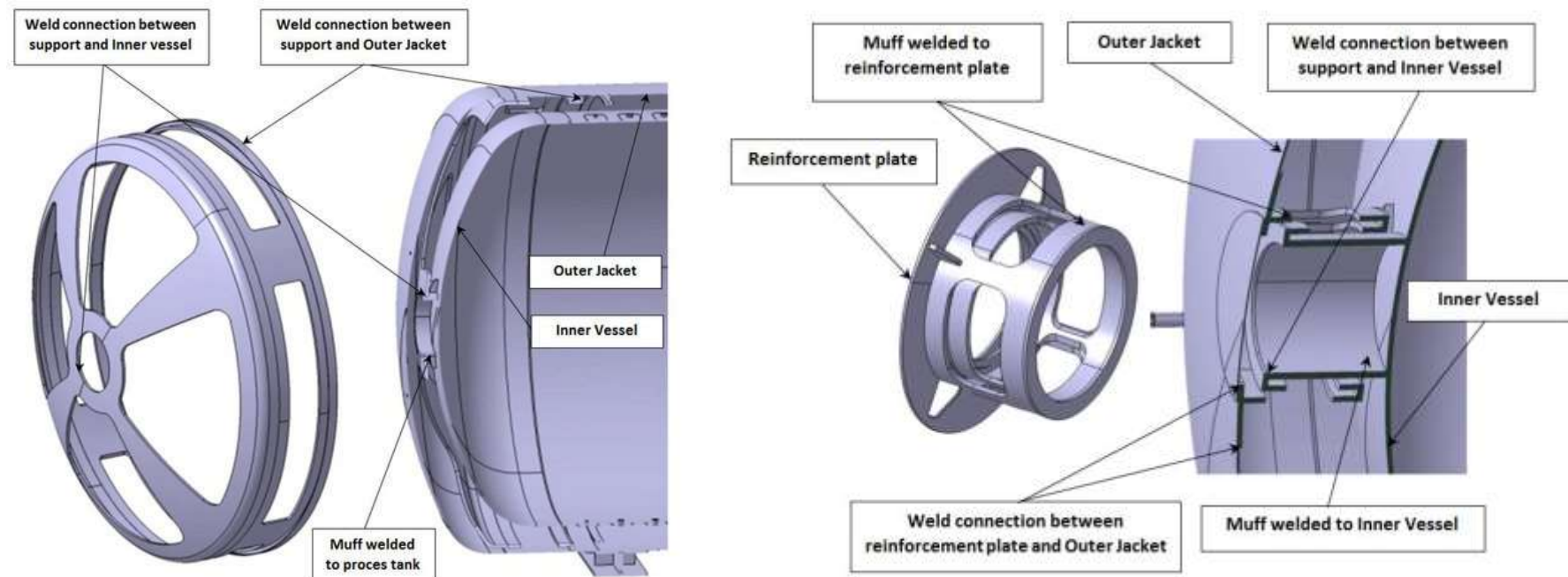

Banaszkiewicz, Tomasz, Maciej Chorowski, Wojciech Gizicki, Artur Jedrusyna, Jakub Kielar, Ziemowit Malecha, Agnieszka Piotrowska, et al. "Liquefied Natural Gas in Mobile Applications—Opportunities and Challenges." *Energies* 13, no. 21 (January 2020): 5673. <https://doi.org/10.3390/en13215673>.

# Cost Breakdown for a High-Capacity LH2 Onboard Storage System

- The highest capacity system is a 2-tank, frame-mounted LH2 storage system with 11 mm MLVI
- Cost breakdown shows shell, liner and insulation costs are the biggest contributors to the tank cost
- Balance of plant costs are the largest fraction of system cost, with the onboard pump and plumbing being the largest contributors for both configurations

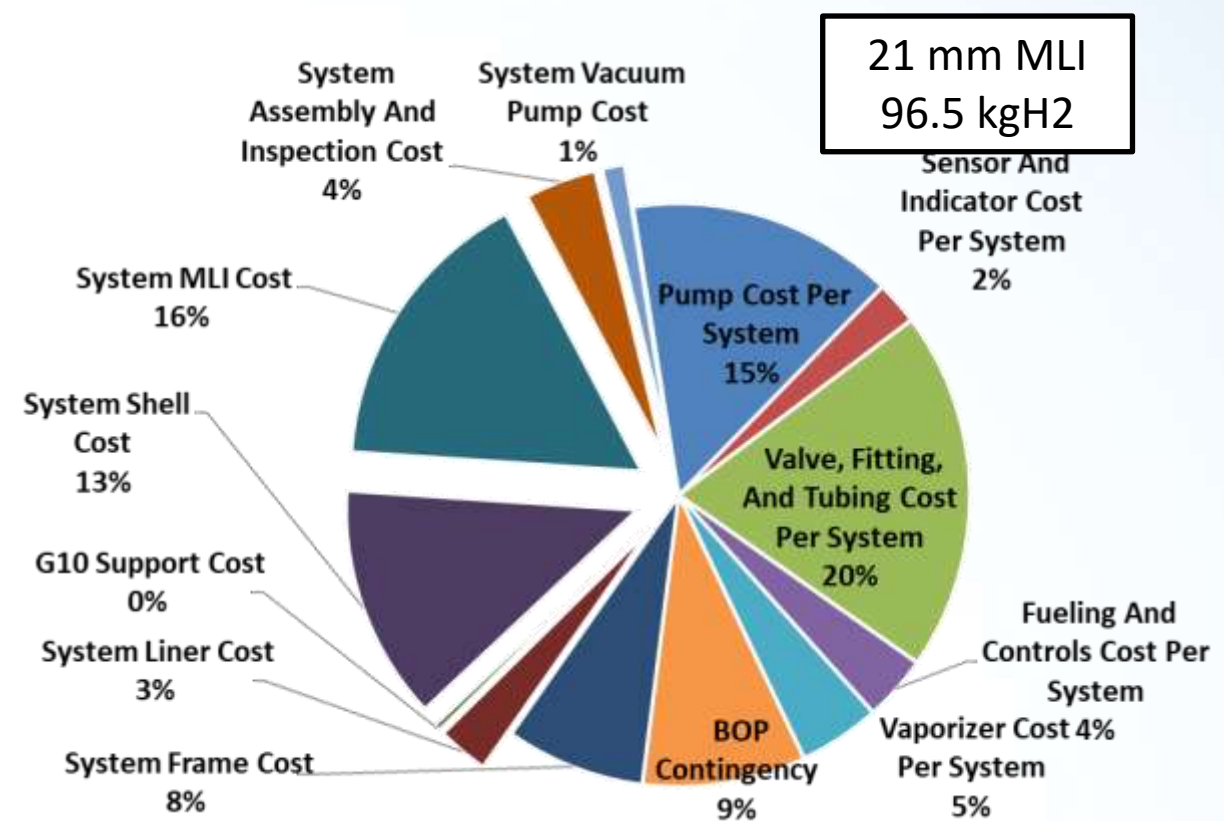
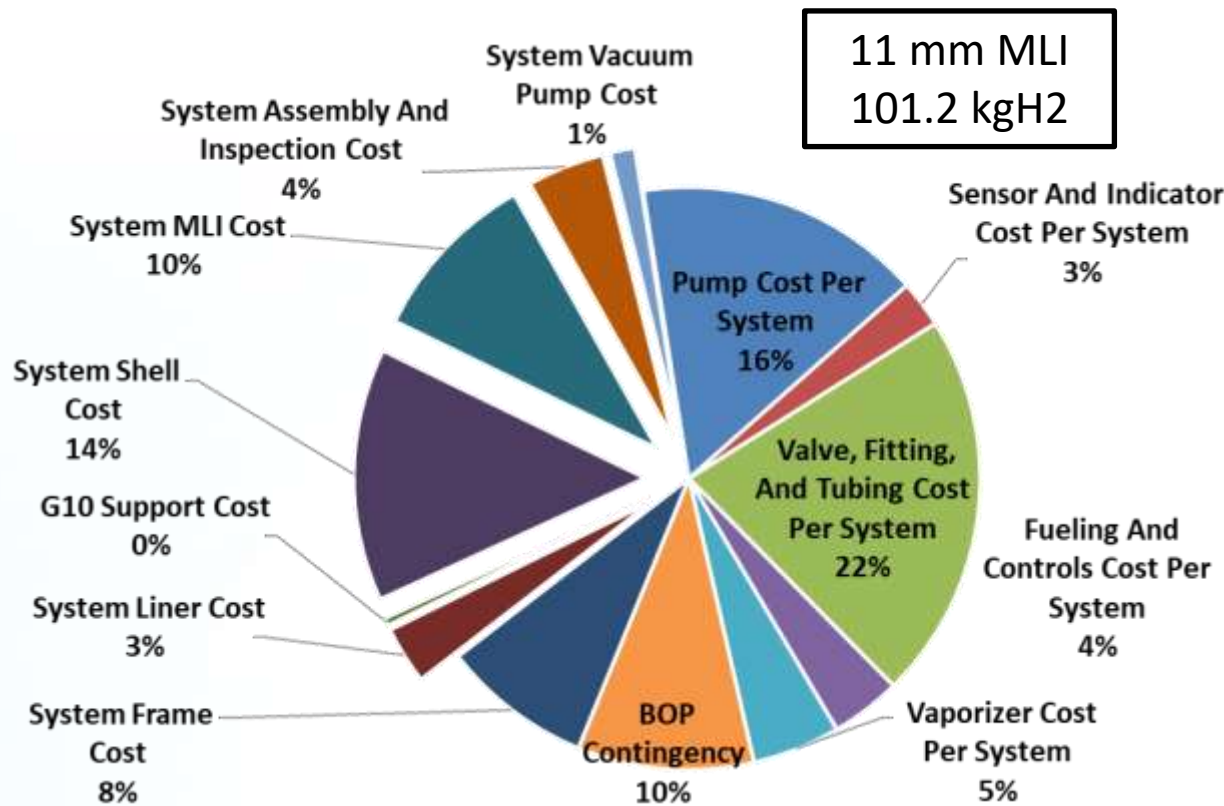

# Multiple LH2 Storage System Configurations Were Considered

- ANL provided system assumptions for multiple configurations including behind-the-cab, frame mounted, and roof mounted with varying tank dimensions and number of tanks
- The storage system total cost only weakly depends on capacity
- Systems with thicker insulation are generally more expensive due to reduced capacity and higher insulation costs

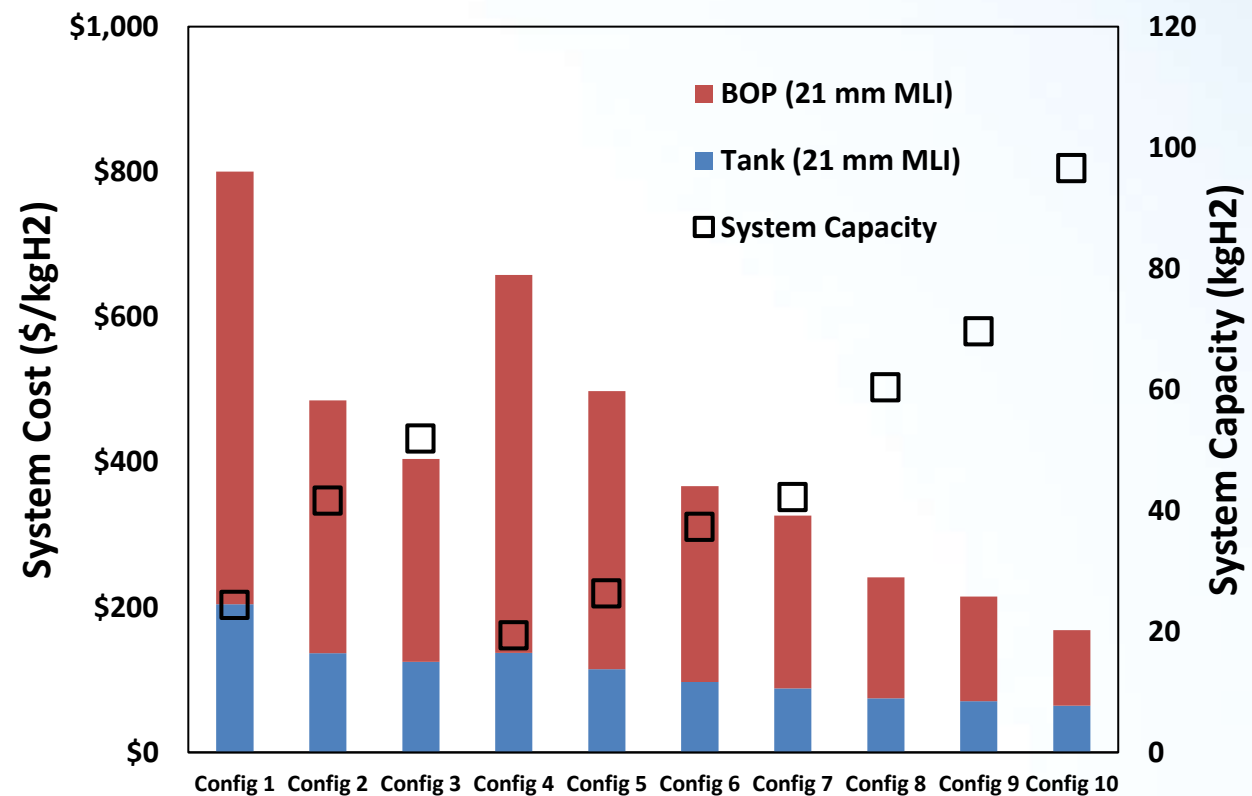
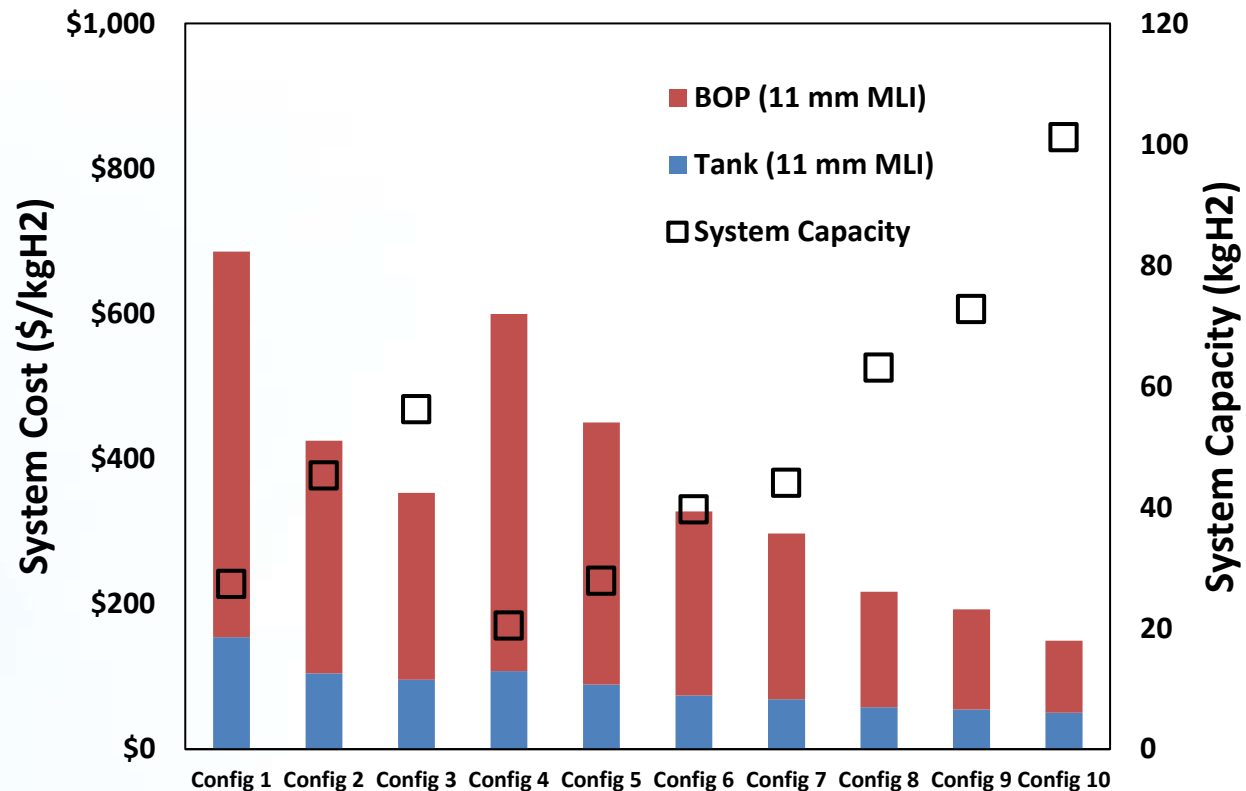

# LH2 System Uncertainty Analysis

- Wide uncertainty intervals were evaluated for all capital & material costs, process times, and geometry parameters
- Most uncertainty skews towards higher cost as shown in the single variable tornado plot
- Projected costs (DFMA projected cost) is at the 10% confidence interval reflecting
- Projected costs are 'very optimistic' based on discussions with manufacturers possibly reflecting ambitious savings due to a forward-looking design and high-volume projections beyond current production

Single variable uncertainty analysis two-tank frame-mounted LH2 storage system manufactured at 100k systems/year

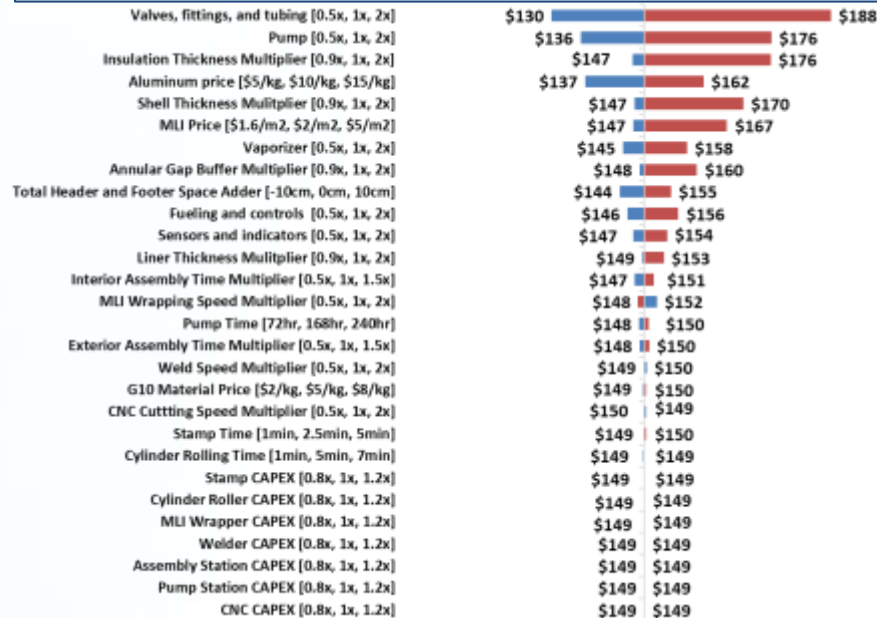

Comparison between DFMA projected cost and 80% confidence interval predicted by Monte Carlo

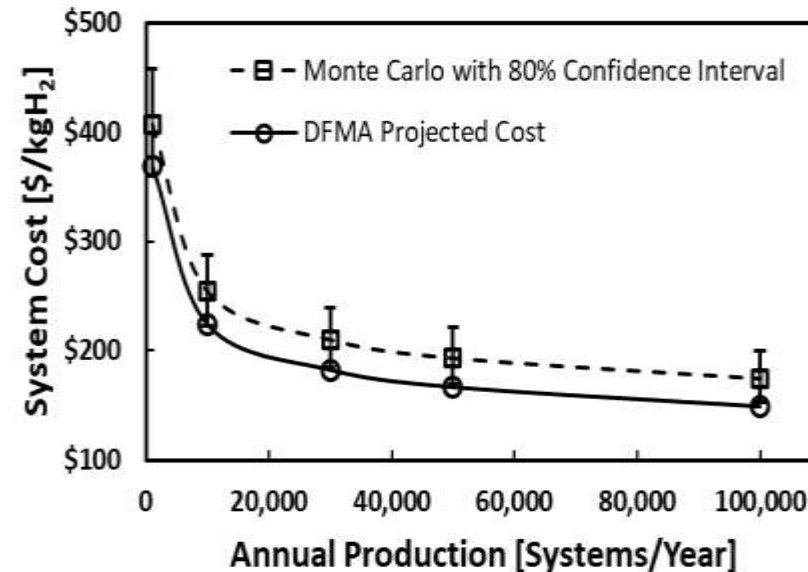

Histogram of Monte Carlo uncertainty analysis for 100k systems per year

DFMA Projected Cost = \$150/kgH<sub>2</sub>

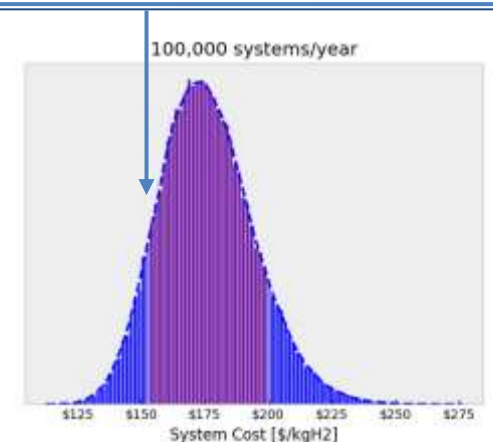

# Liquid Hydrogen Design Specifications

- Where appropriate, geometric and piping specifications borrowed from Linde cryogenic storage specifications (T18V800-F2)
- Cryogenic Gas Association standards recommend a maximum pressure of 12 bar

## Materials

- Outer Vessel: Carbon steel (A36 Steel)
- Inner Vessel: Low temperature resistant austenitic steel (**304 Steel**)

Note: Due to hydrogen embrittlement, a higher strength steel such as 316 may be necessary. However, 304 seems to be the current standard

## Vacuum Insulation

- **Multilayer Insulation**
- **Vacuum to  $<5 \times 10^{-3}$  mbar**

**Red specifications modified for liquid hydrogen**

Geometric and Process Specifications	T18V800-F2
Overall Diameter	3 m
Overall Height	18.050 m
Design Temperature	50 degC
Max/Min Allowable Temperature	50 degC / <b>-253</b> degC
Design Pressure / Max Allowable Working Pressure	<b>12 bar</b>
Complete Tank Weight	29,650 kg +/- 10%
Total Capacity	80,360 L
Net Capacity (T18 at 95%)	76,340 L
Net Capacity (Max Filling Ratio 95%, 1 bara)	61,680 kg
Boil-Off Rate(1 bar, 15°C, Total capacity) Vacuum $< 2 \times 10^{-2}$ mbar	0.19%/day
Discharge Capacity at standard pressure build up vaporizer @ 0.7 * Max. Allow. Working Pressure	600 Nm <sup>3</sup> /h
Capacity of one safety valve at 1.1*MAWP (Cold Conditions)	1090 kg/h

# LH2 Bulk Storage Costs

## INOXCVA

- Manufactured in Gujarat, India
- Designs and manufactures 30m<sup>3</sup>-1,000m<sup>3</sup>
- Customers include Linde, Air Products, Nippon Gases, etc.
- Produce ~1,000 systems per year in Gujarat

## Insights from INOXCVA

- INOXCVA provided rough cost breakdown for LH2 vessel shipped to Houston
- Materials (stainless steel liner and carbon steel shell) dominate their costs
- Valves and piping
  - 30%-40% of their costs for LH2
  - 15%-20% for LNG
- Assumed 20% markup for consistency with other projects

68m<sup>3</sup> LH<sub>2</sub> Vessel Cost Breakdown

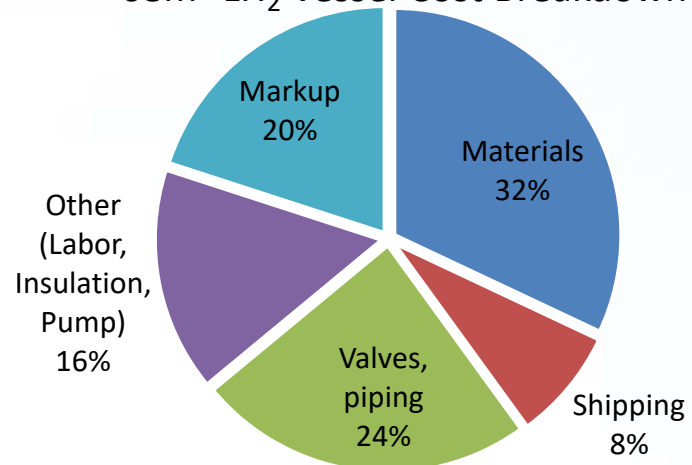

INOXCVA: ~\$600k  
(including markup and shipping)

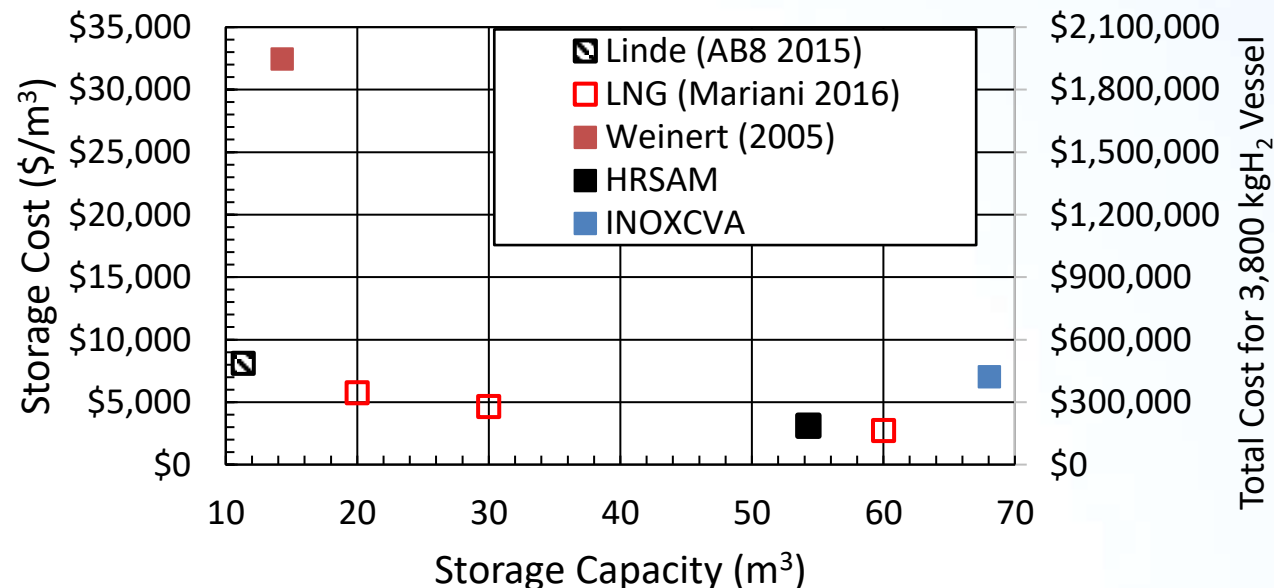

# Valve Costs

- According to INOXCVA,
  - LNG valves take up 15%-20% of total cost
  - LH2 valves take up 30%-40% of total cost
- Compared to LNG, increased costs derived from:
  1. More suitable material required (304L Steel)
  2. Bellows valve required to reduced hydrogen leakage (must be welded in and requires more complex testing)
  3. Longer cryogenic length (valve stem length) to resist cold effects on valve actuation
- Valve costs derived from component supplier specializing in cryogenic valves
- Recommendations from supplier
  - 95% of customers prefer all stainless steel in valves for outdoor applications for enhanced reliability
    - Aluminum bronze is often acceptable for indoor usage
  - Extra testing and certification often required for hydrogen service

						Annual Production Rate (Systems/Year)		
						100	1000	5000
Valves Number	Name	Valve Type	NPS	Schedule	Material	Estimate Cost		
1	Bottom Filling	Manual Control Valve	1 1/2	40	Stainless Steel	\$ 6,851.02	\$ 5,080.84	\$ 4,122.84
2	Pressure Build Up	Manual Control Valve	1 1/2	40	Stainless Steel	\$ 6,851.02	\$ 5,080.84	\$ 4,122.84
3	Vent valve	Manual Control Valve	1	40	Stainless Steel	\$ 4,859.59	\$ 3,603.97	\$ 2,924.43
4	Bottom Gauge	Manual Control Valve	1/8	40	Stainless Steel	\$ 3,677.84	\$ 2,727.56	\$ 2,213.27
5	Gauge Bypass	Manual Control Valve	1/8	40	Stainless Steel	\$ 3,677.84	\$ 2,727.56	\$ 2,213.27
6	Top Gauge	Manual Control Valve	1/8	40	Stainless Steel	\$ 3,677.84	\$ 2,727.56	\$ 2,213.27
11	Discharge	Manual Control Valve	1 1/2	40	Stainless Steel	\$ 6,851.02	\$ 5,080.84	\$ 4,122.84
12	Top Filling	Manual Control Valve	1	40	Stainless Steel	\$ 4,859.59	\$ 3,603.97	\$ 2,924.43
13	Gas Shut Off	Manual Control Valve	1	40	Stainless Steel	\$ 4,859.59	\$ 3,603.97	\$ 2,924.43
18	Change Over Valve	Manual Control Valve	3/4	40	Stainless Steel	\$ 5,261.24	\$ 3,901.83	\$ 3,166.13
21	Trycock	Manual Control Valve	1/2	40	Stainless Steel	\$ 4,722.23	\$ 3,502.09	\$ 2,841.76
26	Pressuring	Manual Control Valve	3/8	40	Stainless Steel	\$ 4,325.04	\$ 3,207.53	\$ 2,602.74
SV1	Safety Valve 1	Safety Valve	1	40	Stainless Steel	\$ 5,682.80	\$ 4,214.47	\$ 3,419.82
SV2	Safety Valve 2	Safety Valve	1	40	Stainless Steel	\$ 5,682.80	\$ 4,214.47	\$ 3,419.82
PC	Pressure Regulator	Pressure Regulator	1	40	Stainless Steel	\$ 5,682.80	\$ 4,214.47	\$ 3,419.82
NRV	Non Return Valve	Non Return Valve	1/2	40	Stainless Steel	\$ 1,035.93	\$ 768.26	\$ 623.40
RV/O	Relief valve - Outer Jacket	Relief valve - Outer Jacket	6	40	Stainless Steel	\$47,868.57	\$35,500.22	\$28,806.54

Learning rate of 91.4% based on supplier bulk discount estimates



# DFMA Cost Summary

- Total price (with 20% markup) estimated by DFMA for 100 units/year is \$620k which is supported by the INOXCVA estimate of \$600k
- Cost reductions for the vessels as a function of manufacturing rate are primarily driven by reduction in valve costs
  - Further work can be done to understand cost reductions associated with bulk material purchases
- Cost of testing and certifications will slightly increase the cost estimated

	Units	100 Units per Year	INOXCVA Estimate
Materials	%	38%	32%
Piping and Valves	%	21%	24%
Other	%	10%	16%
Contingency	%	3%	
Shipping	%	8%	8%
Markup	%	20%	20%
<b>Total Cost</b>	<b>\$</b>	<b>\$620k</b>	<b>\$600k</b>

Stationary LH2 Cost vs Production Rate

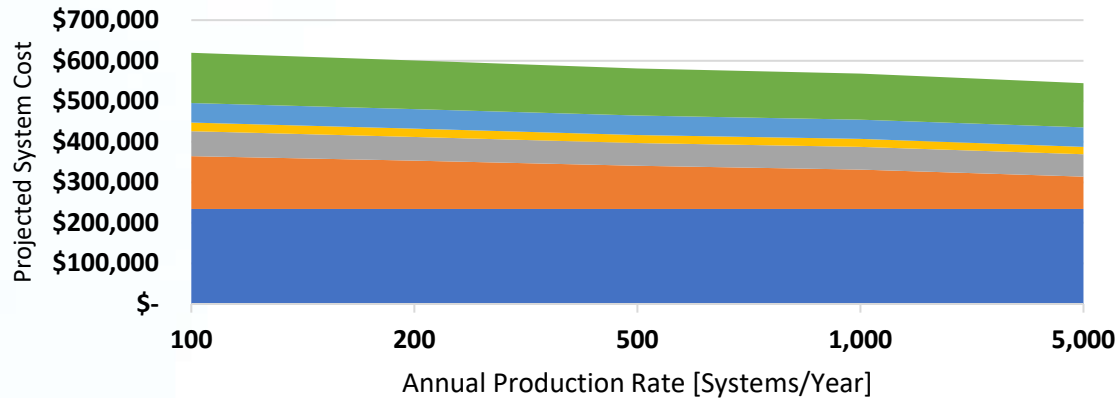

- Materials
- Piping and Valves
- Other
- Contingency
- Shipping
- Markup

% of Total Cost vs Production Rate

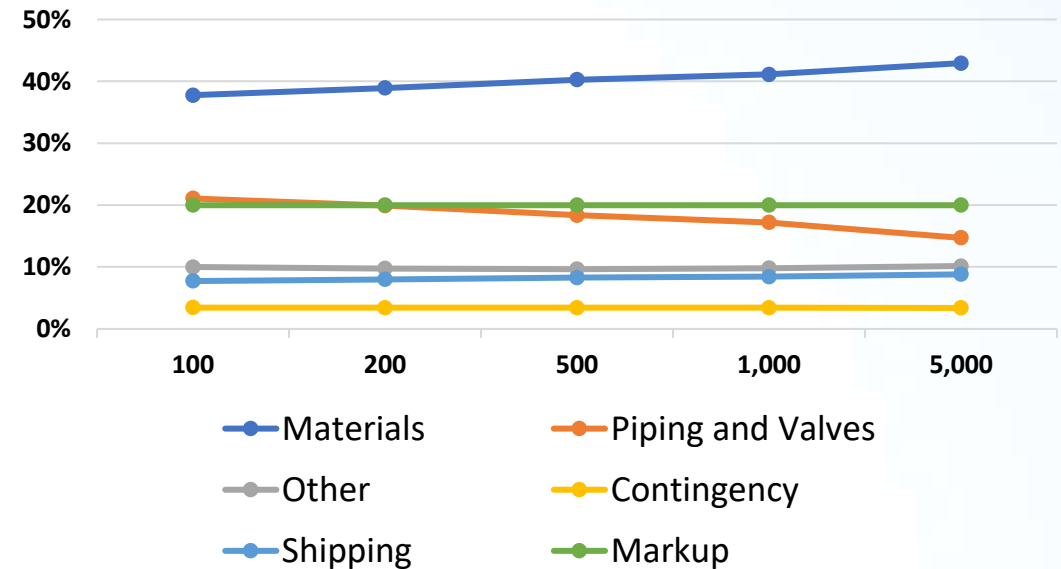

# Collaborations & Coordination

<p><b>MDV/HDV</b></p>	<p><b>Argonne</b>—finite element analysis, system performance analysis  <b>PNNL</b>—system assumptions          Informal discussions, system assumptions, and BOP—<b>INOXCVA, Chart Industries, WEKA</b></p>
<p><b>Onboard LH2 storage</b></p>	<p><b>ANL</b>—finite element analysis and performance analysis  <b>LLNL</b>—System and manufacturing requirements  <b>ILK Dresden</b>—informal discussions about cryogenic pump costs and performance</p>
<p><b>Tube trailers</b></p>	<p><b>CATEC Gases</b>—manufacturing assumptions and costs  <b>Hexagon (planned)</b>—manufacturing assumptions and costs</p>
<p><b>LH2</b></p>	<p><b>ANL</b>—System assumptions discussed with Amgad Elgowainy and Rajesh Ahluwalia  <b>Chart Industries</b>—Dewar and vaporizer costs  <b>INOXCVA</b>—Dewar costs  <b>WEKA</b>—BOP component costs and requirements</p>

# Summary

- Class 8 Long Haul

- Meeting DOE targets for Class 8 Long Haul trucks with 700 bar Type 4 storage system requires a step change in carbon fiber costs in addition to other cost reductions such as reduced carbon fiber usage from relaxed safety factors
- LH2 storage systems for Class 8 Long Haul trucks are promising based on system cost and capacity with a couple of caveats.
  - Current analysis reflects ambitious design and manufacturing
  - Higher fuel costs may make total cost of ownership less compelling than compressed gas storage

- Hydrogen Refueling Stations

- Modeled cost of cryogenic bulk storage systems show reasonable agreement with manufacturers cost breakdowns

# Proposed Future Work

- Class 8 Long Haul
  - Model LNG system costs and compare with commercially available systems as a validation of LH2 cost
  - Manuscript in preparation with Argonne on LH2 system performance and cost
  - Manuscript in preparation comparing liquid, cryo-compressed, and compressed storage costs
- LH2 bulk storage
  - Analysis of long-term, multi-tonne bulk storage started for FY2022

\*Any proposed future work is subject to change based on funding levels

# Technical Backup and Additional Information

# Technology Transfer Activities

Technology transfer does not apply to this analysis-type project

# CNG Retrofit storage systems serve as baseline for Available Storage System Envelope

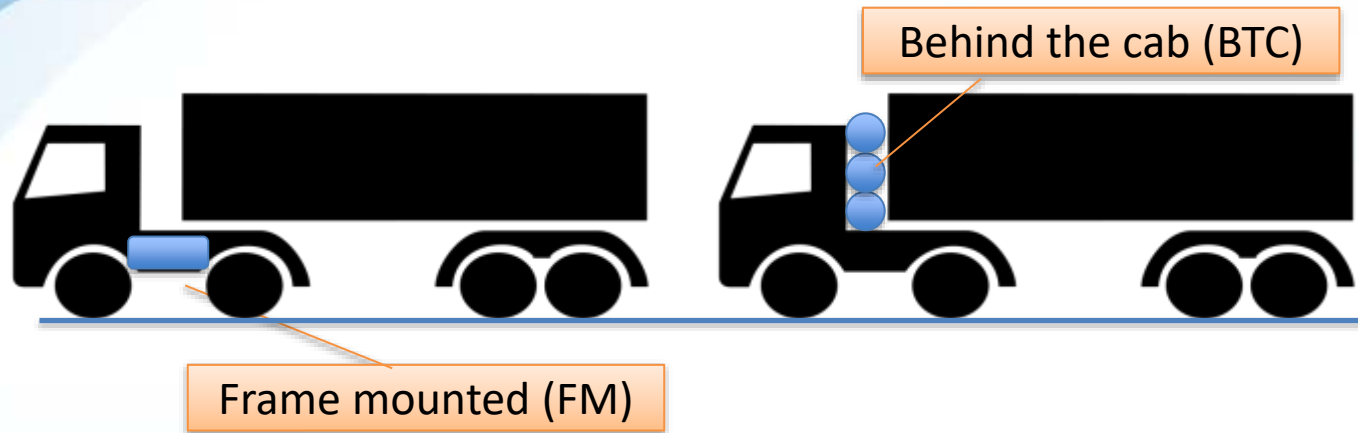

- H<sub>2</sub> storage capacity estimated from envelope<sup>1</sup>
- Based on commercially available CNG packages<sup>2</sup>
- Note that some configurations can be mounted in more than one locations (e.g. Configuration 2 can be mounted on the roof or behind the cab)

1. [https://www.hydrogen.energy.gov/pdfs/review19/st100\\_james\\_2019\\_o.pdf](https://www.hydrogen.energy.gov/pdfs/review19/st100_james_2019_o.pdf), [https://www.hydrogen.energy.gov/pdfs/review19/st001\\_ahluwalia\\_2019\\_o.pdf](https://www.hydrogen.energy.gov/pdfs/review19/st001_ahluwalia_2019_o.pdf)
2. <http://www.a1autoelectric.com/>

Frame Mounted (FM) 2 tanks	Roof Mounted (RM) 4 tanks	Behind the Cab (BTC) 2-4 tanks
<b>Configuration Number: outer diameter (cm) x outer length (cm)</b>		
Configuration 4: 53 x 152	Configuration 1: 41 x 203	Configuration 2: 41 x 203
Configuration 5: 53 x 203	Configuration 2: 41 x 246	Configuration 6: 53 x 203
Configuration 6: 53 x 102	Configuration 3: 41 x 246	
Configuration 7: 66 x 152		
Configuration 8: 66 x 203		
Configuration 9: 66 x 229		
Configuration 10: 66 x 305		

# Class 8 Long Haul Truck Onboard LH2 Storage System Manufacturing Process Flow

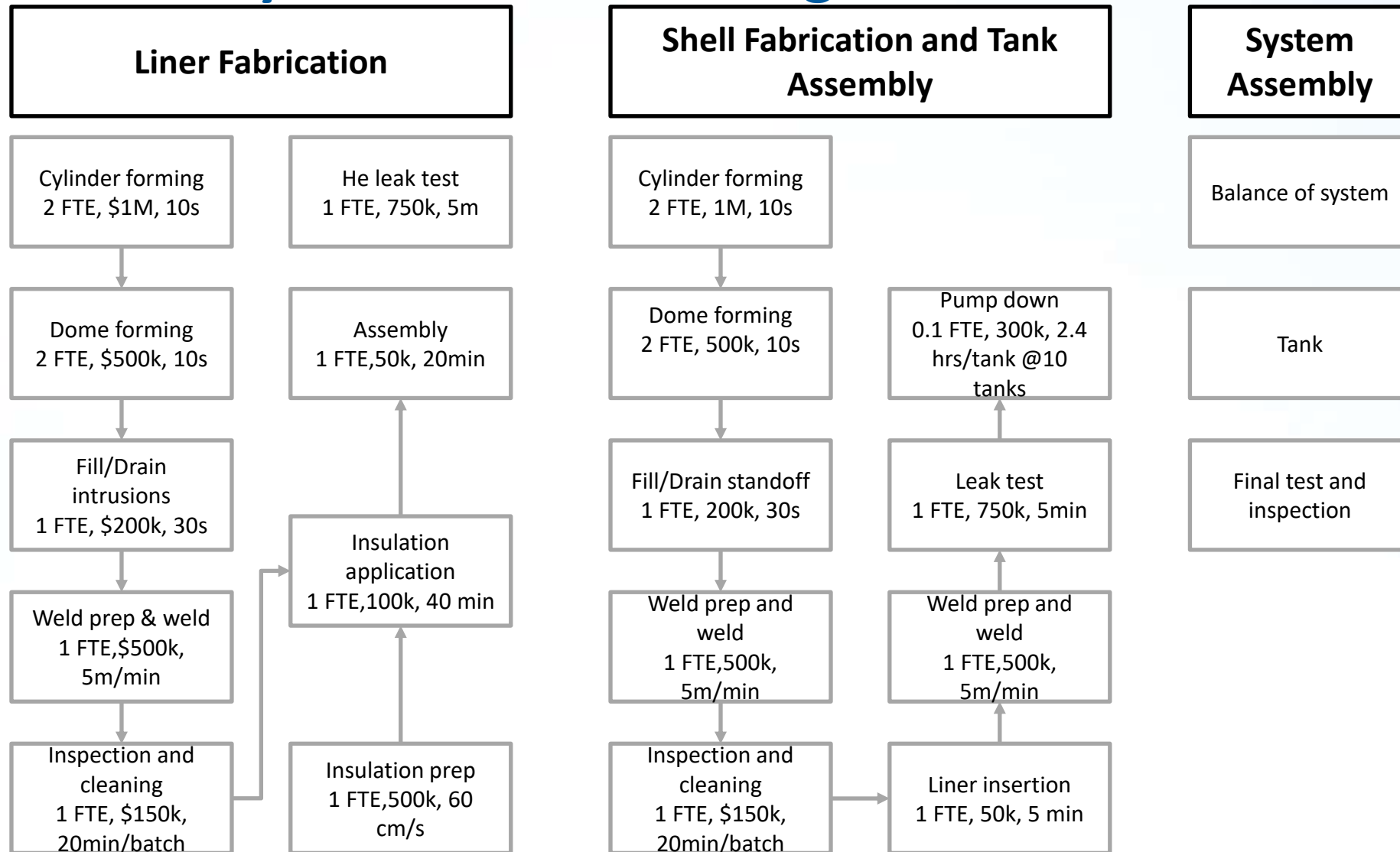



# 700 bar Type 4 Manufacturing Process Flow

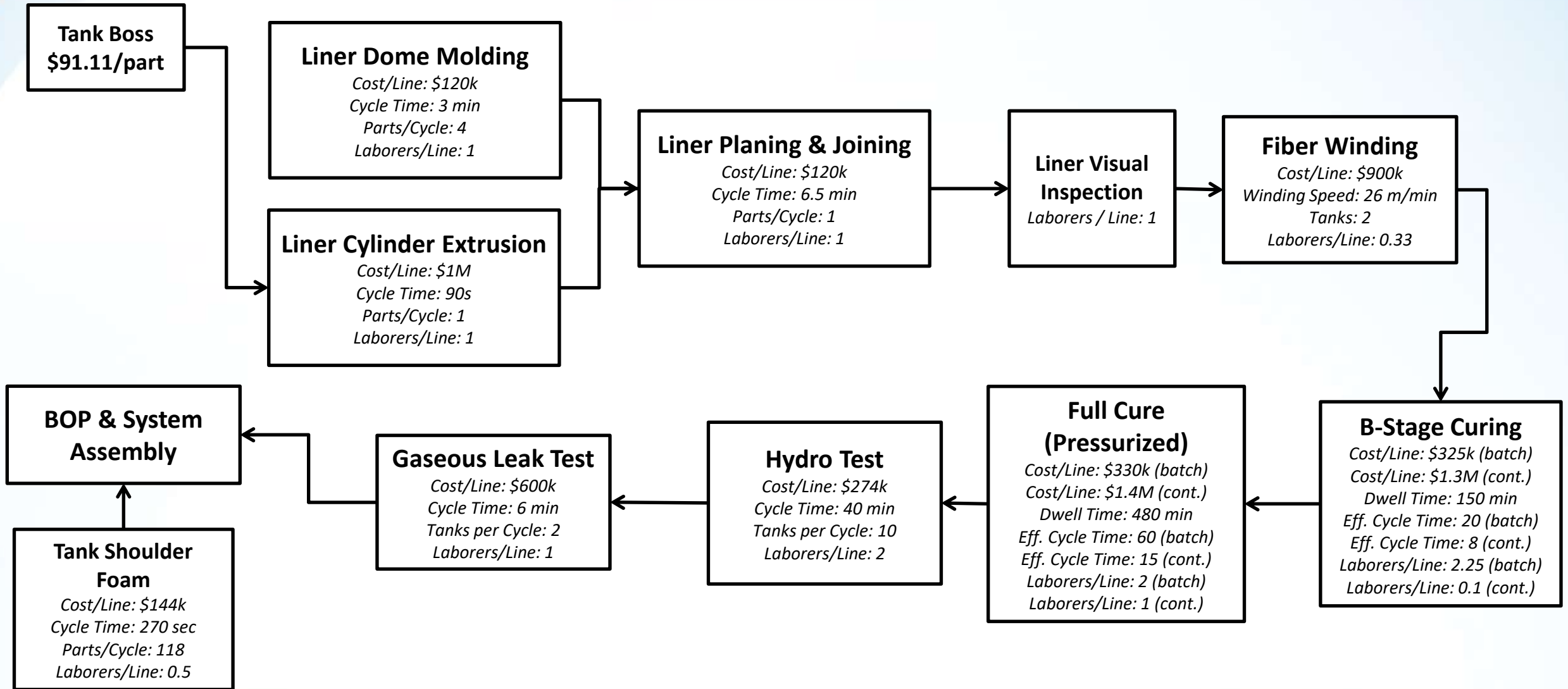

# Manufacturing Process Flow

