

# Photoelectrochemical Water Systems for H<sub>2</sub> Production

2007 DOE Hydrogen, Fuel Cells, and Infrastructure  
Technologies Program Review

May 17, 2007

John A. Turner, Todd Deutsch, Jeff Head, and Paul Vallett  
National Renewable Energy Laboratory

*jturner@nrel.gov 303-275-4270*

This presentation does not contain any proprietary or confidential information.

# Overview

## Timeline

- Project start date: 1991
- Project end date: tbd
- Percent complete: tbd

## Budget

- Total project funding to date
  - DOE share: \$5.9M (~0.75 FTE + postdoc, average)
- Funding received in FY 2006: \$140k
- Funding for FY 2007: \$800k

## Barriers

### Barriers addressed

- ✓ M. Materials durability
- ✓ O. Materials efficiency
- ✓ N. Device configuration designs

## Partners

### Interactions/collaborations

- UNLV-SHGR
- University of Nevada, Reno
- Colorado School of Mines
- University of Colorado
- Program production solicitation
  - MVSystems, Inc
  - Midwest Optoelectronics

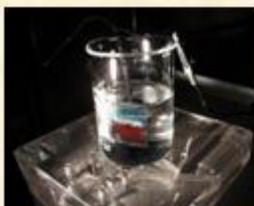

# Photoelectrochemical Hydrogen Production: UNLV-SHGR Program Subtask

**Robert Perret**  
UNLVRF

15 May 2007

**#PDP37**

*This presentation does not contain any proprietary or confidential information*



# Photoelectrochemical Conversion

## Goals and Objectives

*The goal of this research is to develop a stable, cost effective, photoelectrochemical-based system that will split water using sunlight as the only energy input. Our objectives are:*

1. Identify and characterize [new semiconductor materials](#) that have appropriate bandgaps and are stable in aqueous solutions.
2. Study [multijunction semiconductor systems](#) for higher efficiency water splitting.
3. Develop techniques for the [energetic control](#) of the semiconductor electrolyte interface and for the preparation of transparent [catalytic coatings](#) and their application to semiconductor surfaces.
4. Identify environmental factors (e.g., pH, ionic strength, solution composition, etc.) that affect the energetics of the semiconductor, the properties of the catalysts, and the stability of the semiconductor.
5. Develop [database](#) to house a library of the material properties discovered by the DOE program.

# Material Challenges (*the big three*)

## Characteristics for Ideal Photoelectrochemical Hydrogen Production Material

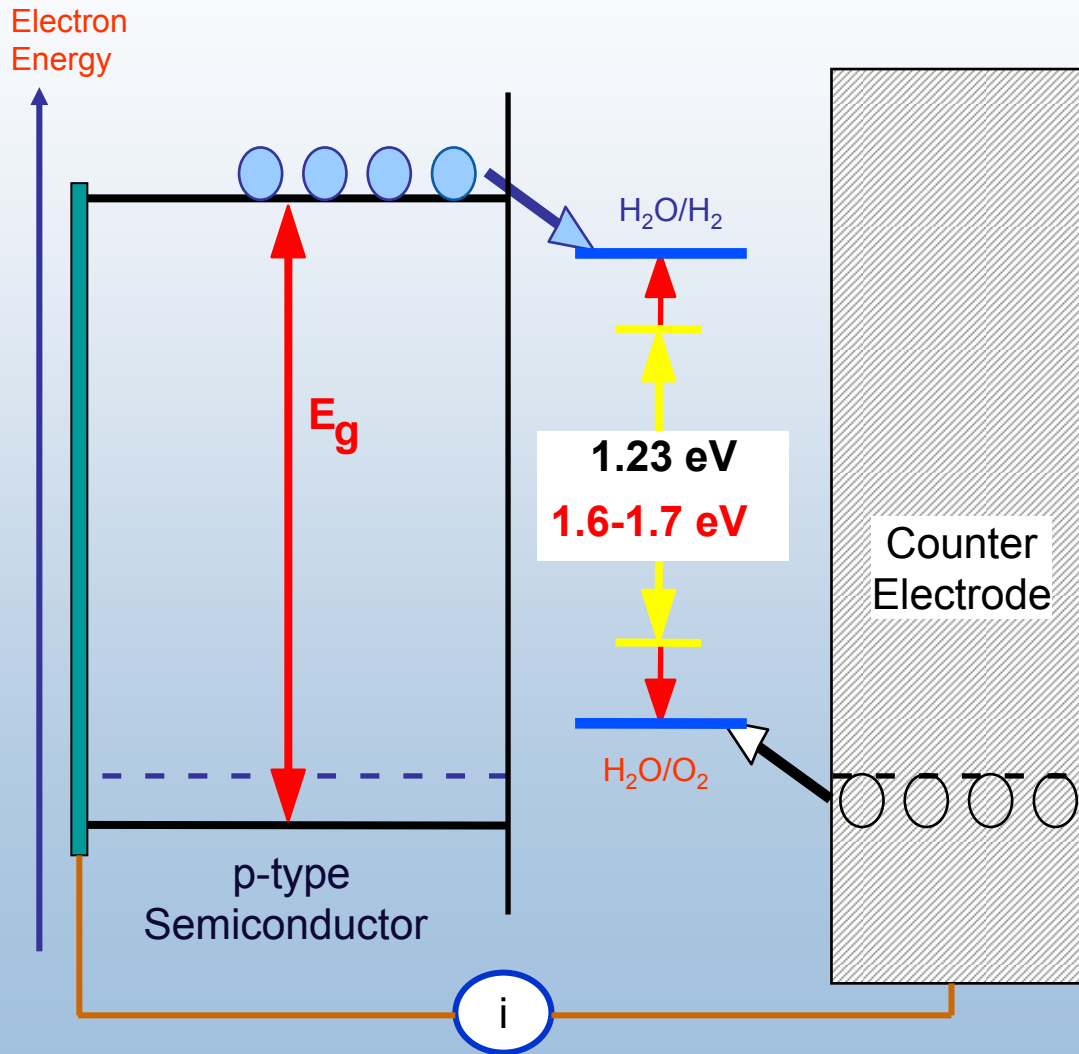

- **Efficiency** – band gap ( $E_g$ ) must be at least 1.6-1.7 eV, but not over 2.2 eV; must have high photon to electron conversion efficiency
- **Material Durability** – semiconductor must be stable in aqueous solution
- **Energetics** – band edges must straddle  $H_2O$  redox potentials (**Grand Challenge**)

**All must be satisfied simultaneously.**

# Approach: High Efficiency Materials & Low-Cost Manufacturing

PEC devices must have the same internal photon-to-electron conversion efficiency as commercial PV devices.

- III-V materials have the highest solar conversion efficiency of any semiconductor material
  - Large range of available bandgaps
  - ....but
    - Stability an issue – nitrides show promise for increased lifetime
    - Band-edge mismatch with known materials – tandems an answer
- I-III-VI materials offer high photon conversion efficiency and possible low-cost manufacturing
  - Synthesis procedures for desired bandgap unknown
  - ....but
    - Stability in aqueous solution?
    - Band-edge mismatch?
- Other thin-film materials with good characteristics
  - SiC: low-cost synthesis, stability
  - SiN: emerging material

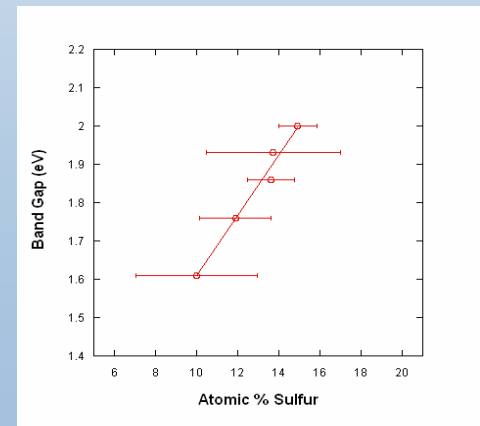

# Approach: Materials Summary

The primary task is to synthesize the semiconducting material or the semiconductor structure with the necessary properties. This involves material research issues (material discovery), multi-layer design and fabrication, and surface chemistry. Activities are divided into the task areas below – focus areas in black:

- GaPN - NREL (high efficiency, stability)
- $\text{CuInGa}(\text{Se},\text{S})_2$  - UNAM (Mexico), NREL (low cost)
- Silicon Nitride - NREL (protective coating, new material)
- $\text{GaInP}_2$  - NREL (fundamental materials understanding)
- Energetics
  - Band edge control
  - Catalysis
  - Surface studies



# III-V Nitrides: $\text{GaP}_{1-x}\text{N}_x$

Previous work with III-V nitrides for PEC water splitting showed improved stability with very small amounts of nitrogen, but problems with morphology at higher nitrogen content

- $\text{GaP}_{1-x}\text{N}_x$ 
  - Addition of small amounts of N causes GaP band gap to narrow (bowing) and transition to become direct
  - Nitrogen enhances stability



Dr. Todd Deutsch

$\text{GaP}_{1-x}\text{N}_x$  Epilayer Direct Band Gap

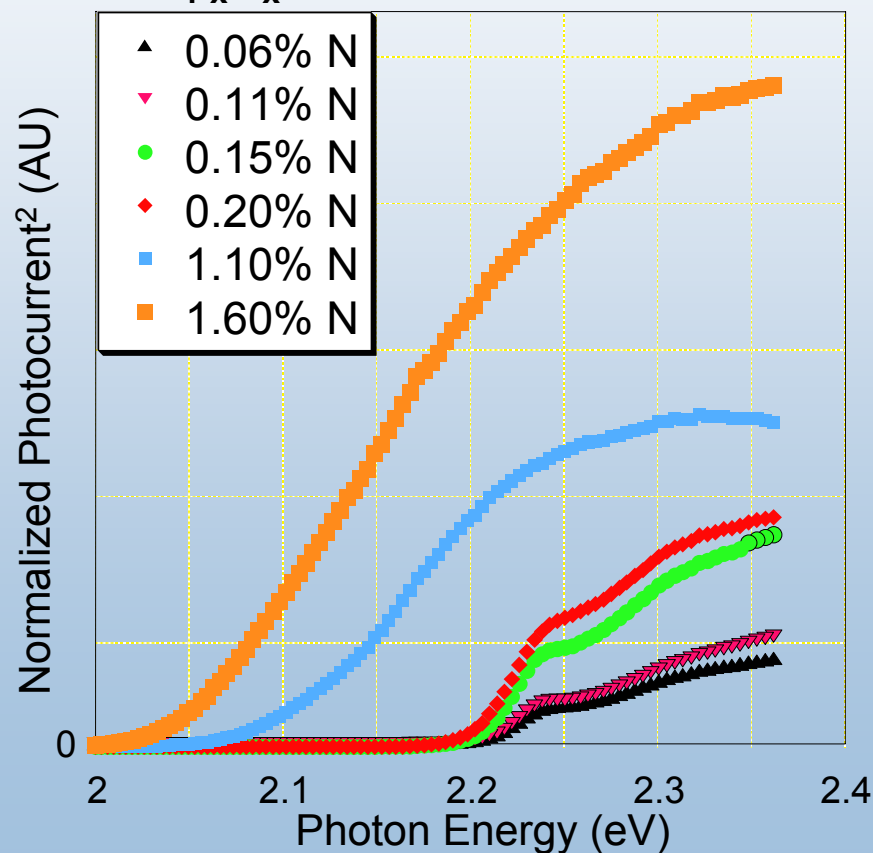



# Increasing the Nitrogen Content: Lattice Matching Using Indium as a Lattice Expander

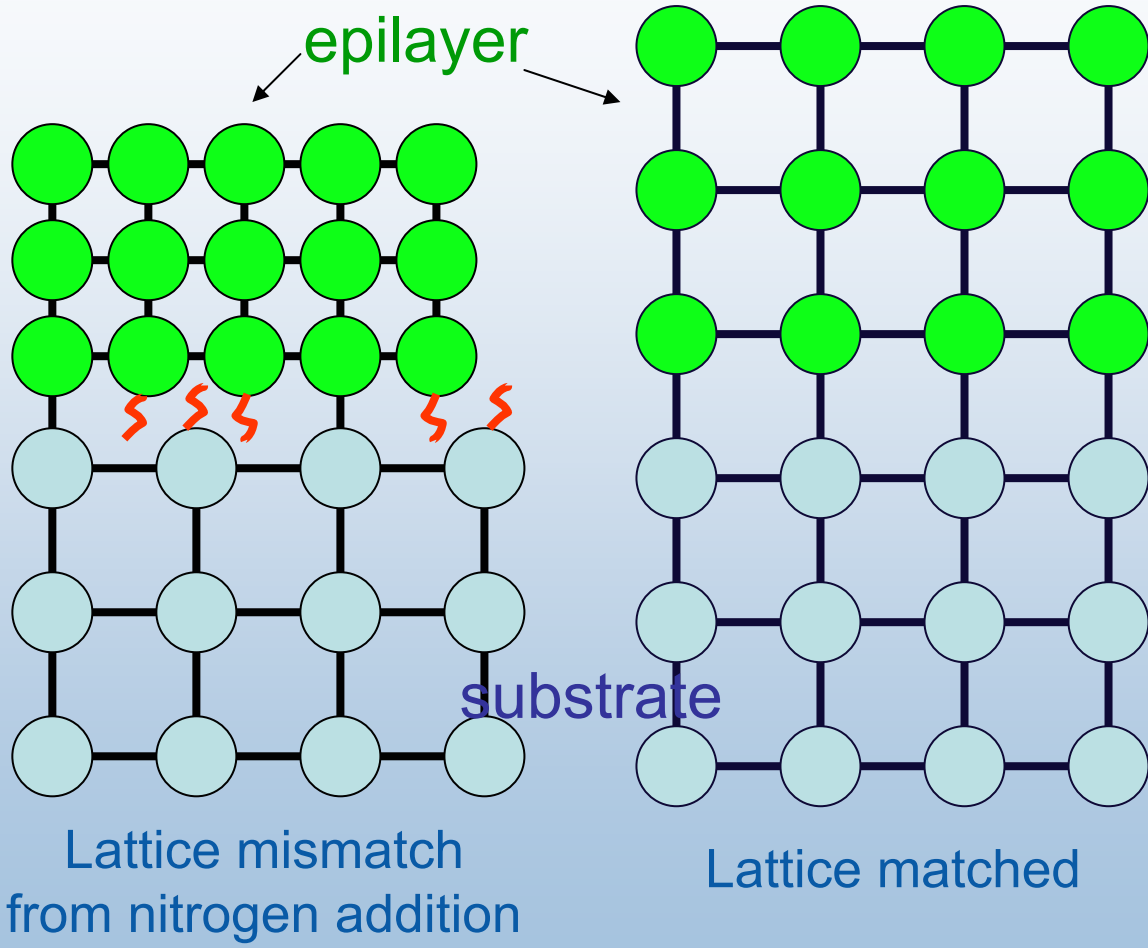

**Results:** Lattice matched with more than 2% nitrogen

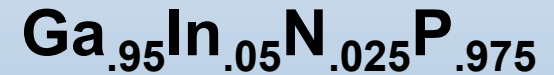
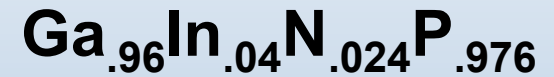

Jeff Head, Paul Vallett

# Photocurrent Spectroscopy To Determine the GaInPN Band Gap

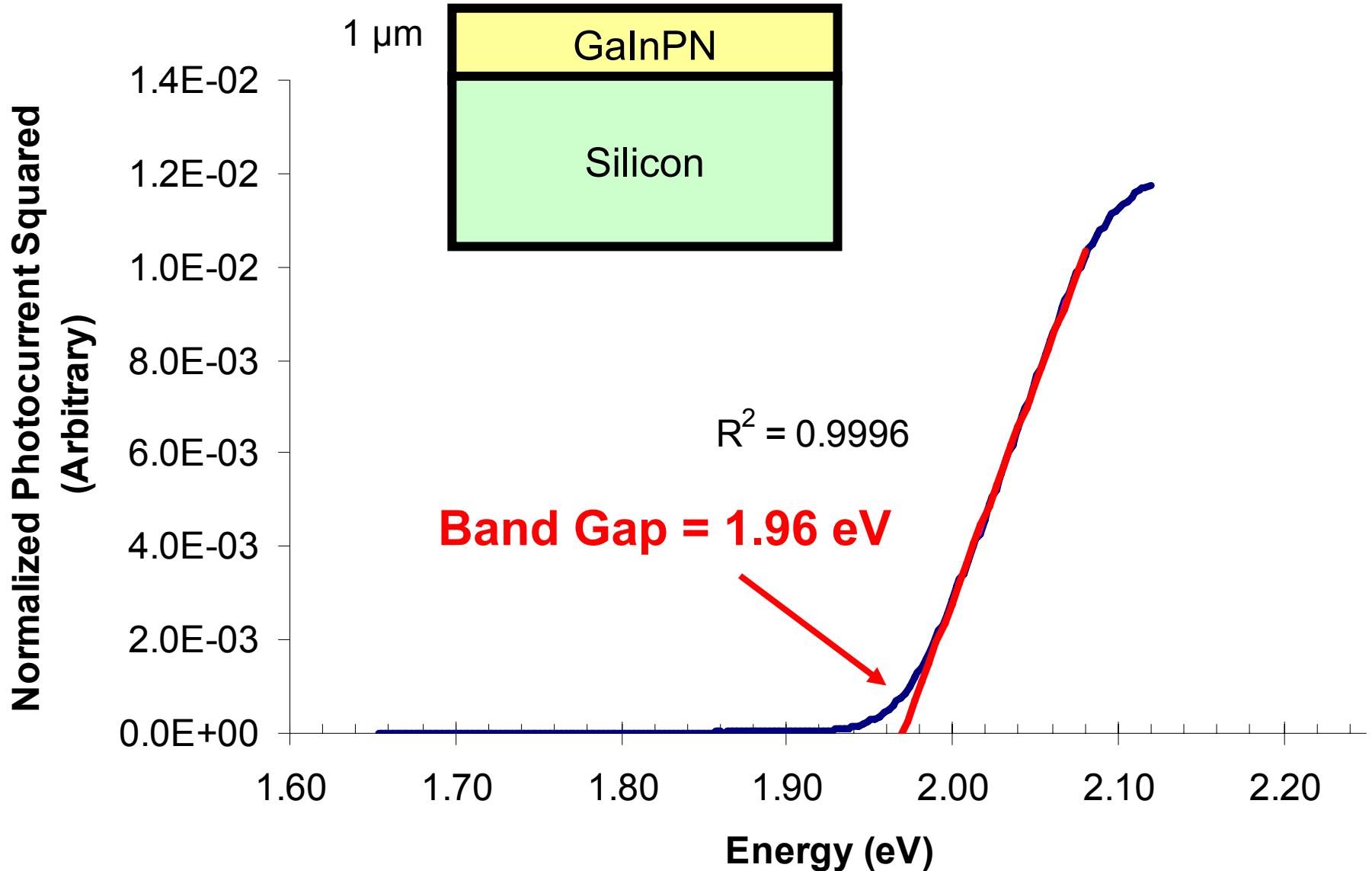

# Durability Analysis Showed Improved Corrosion Resistance

- 24-hour corrosion test
  - Constant 5 mA/cm<sup>2</sup> applied current
  - Sample illuminated at 1 sun
- Profilometry etch depth
  - 0.1 μm average

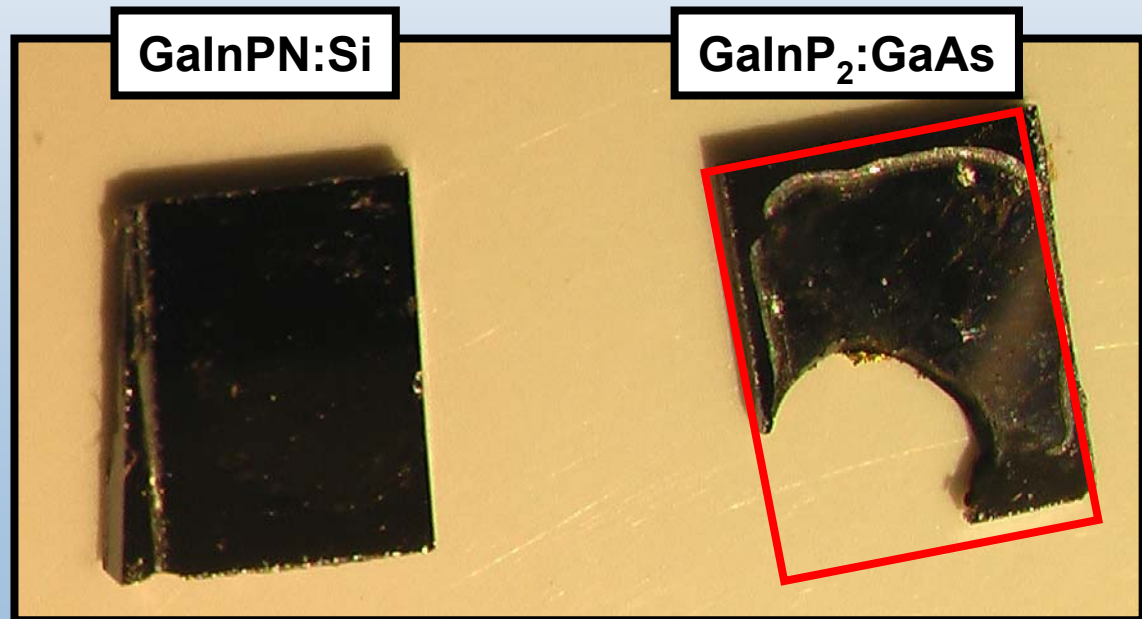

# GaInPN on Silicon Tandem Cell

- GaInPN top cell
  - Visible light conversion
  - Corrosion protection
- Si-bottom cell
  - Absorbs IR radiation passing through the top cell
  - Provides energy to lower  $h^+$  below  $O_2$  redox potential
- Also applied back surface field for field-aided charge collection

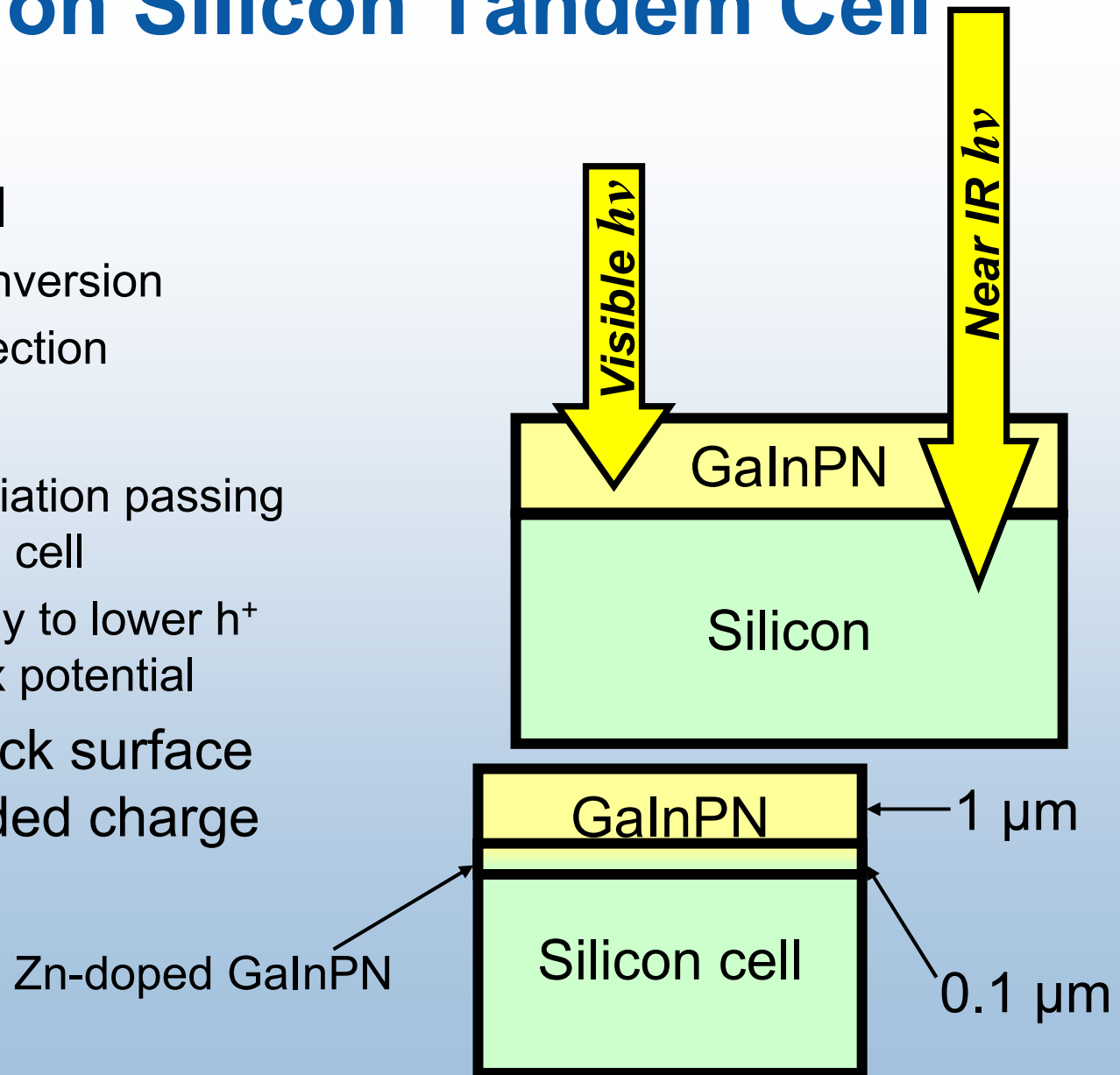

# PEC Energy Diagram

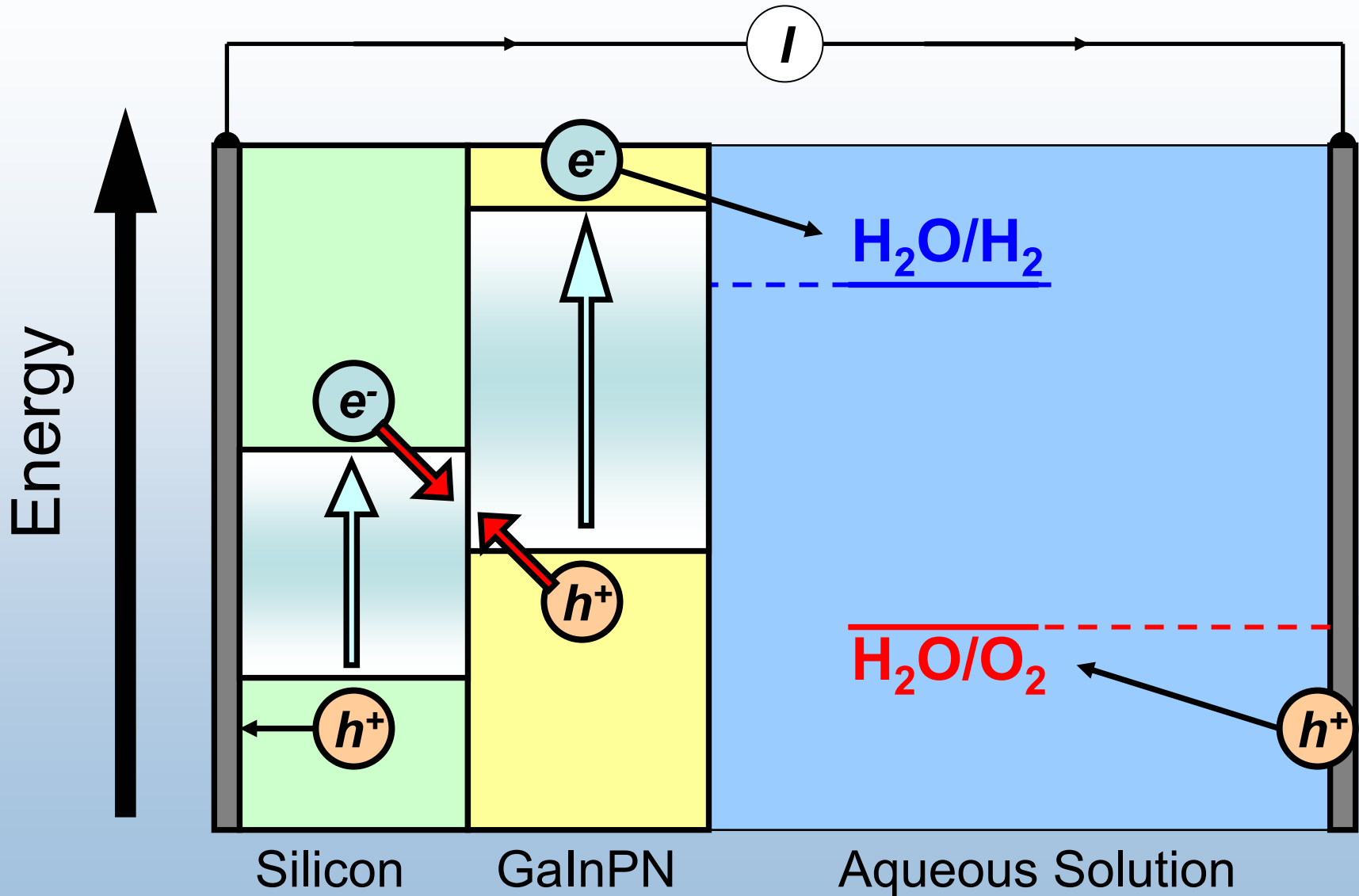

# Band Edge Energetics

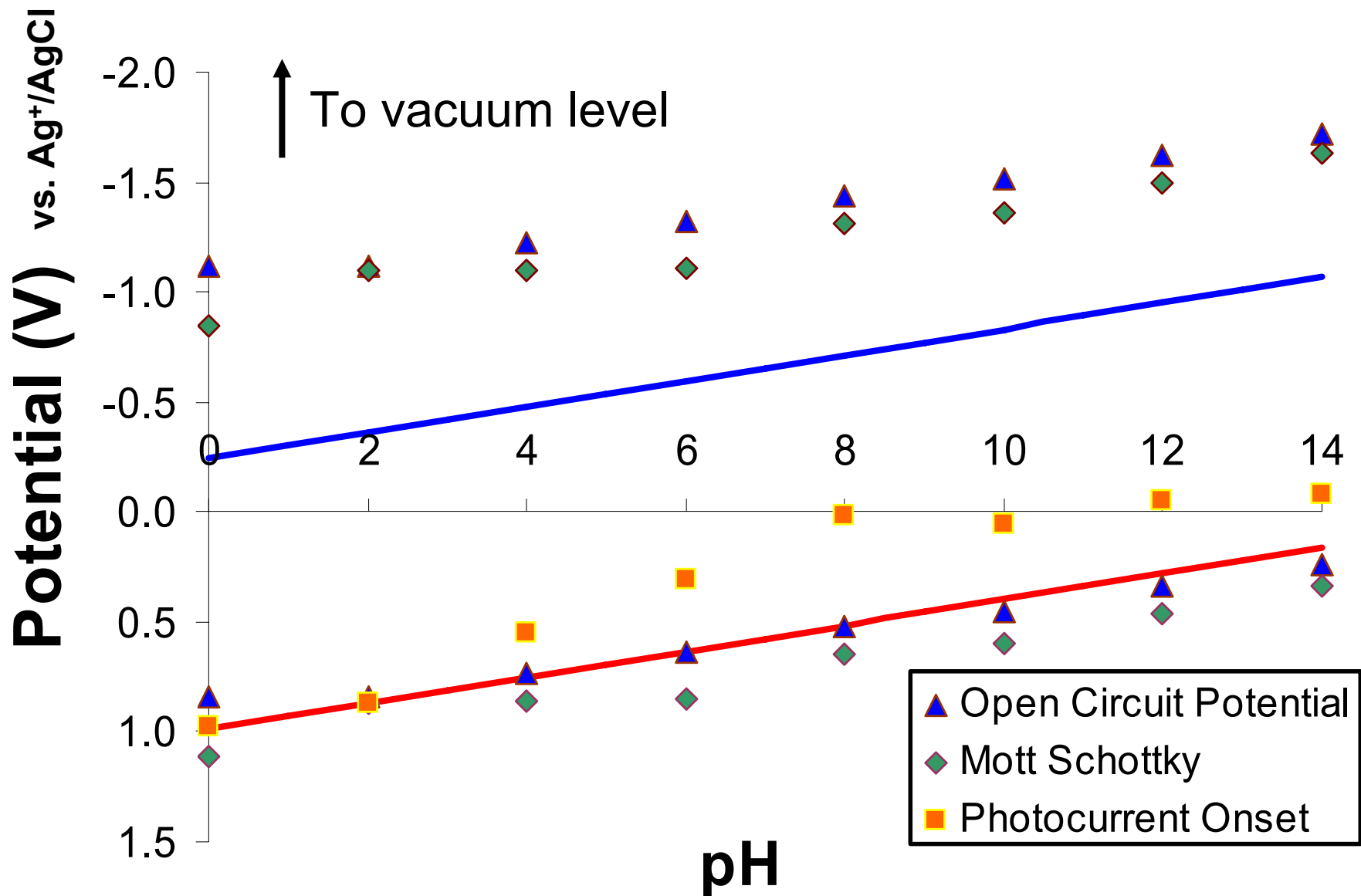

# Water Splitting

- Zn-doped layer provides back surface field and improves efficiency
- Nitrogen negatively impacts the electronic properties of material
- Photon to chemical energy conversion efficiency
  - GaInPN: ~25%
  - GaInP<sub>2</sub>: ~60%



Jeff Head, Paul Vallett

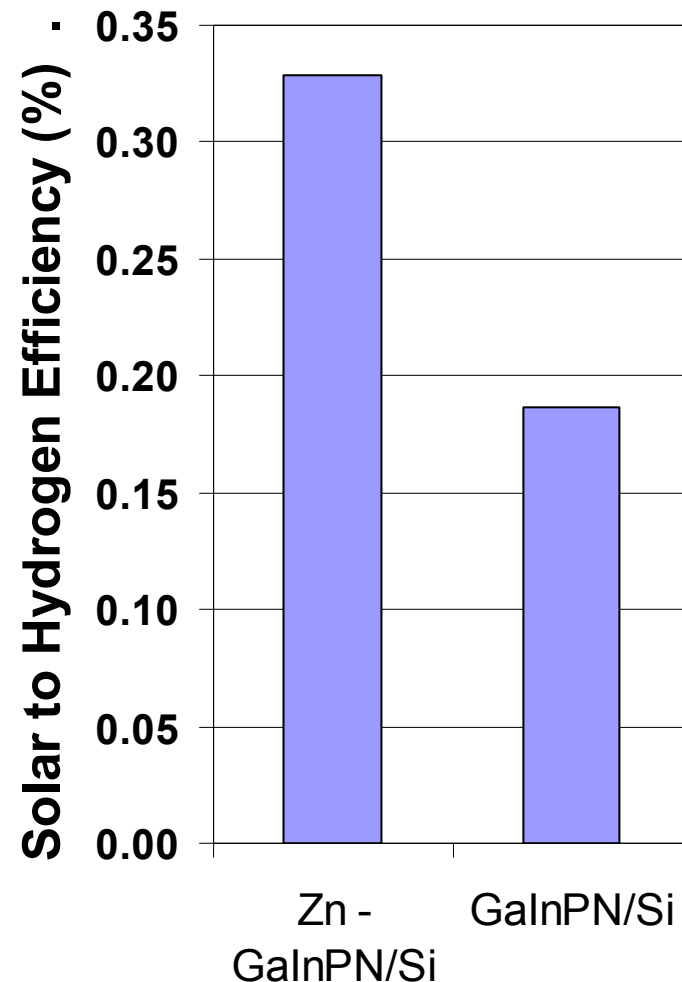

# Integrated Photon-to-Electron Current Efficiency (IPCE)

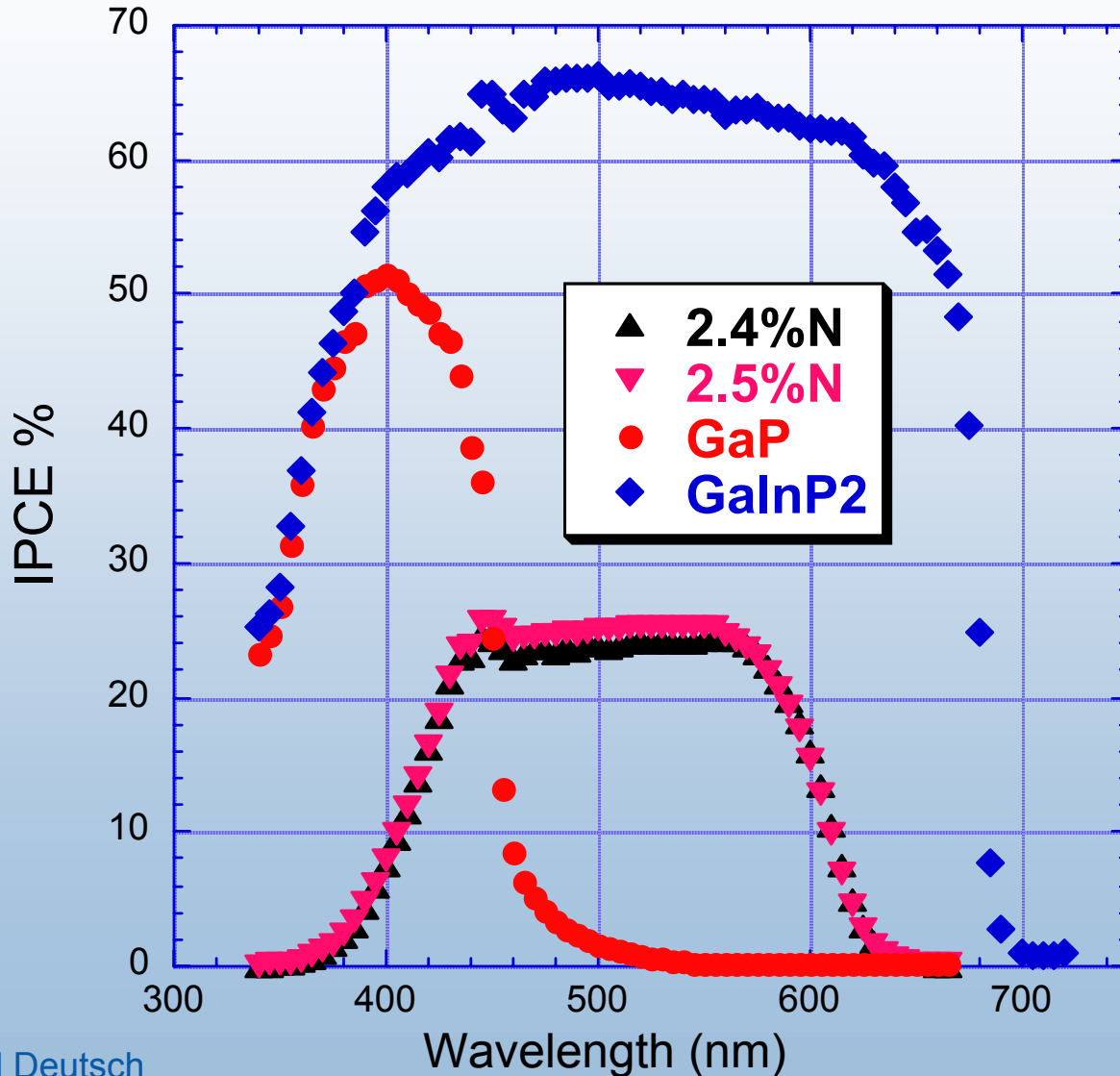

PEC devices must have the same internal photon-to-electron conversion efficiency as commercial PV devices.



# CuGaSe<sub>2</sub> Tandem Cell Configuration: Possible High Efficiency, But a New Deposition Approach is Required

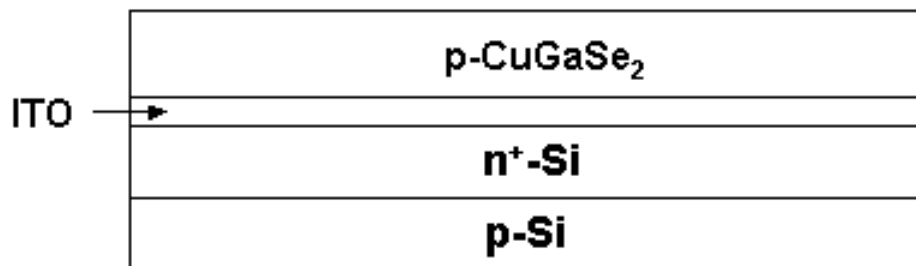

Maximum theoretical  
water-splitting  
efficiency = 28%

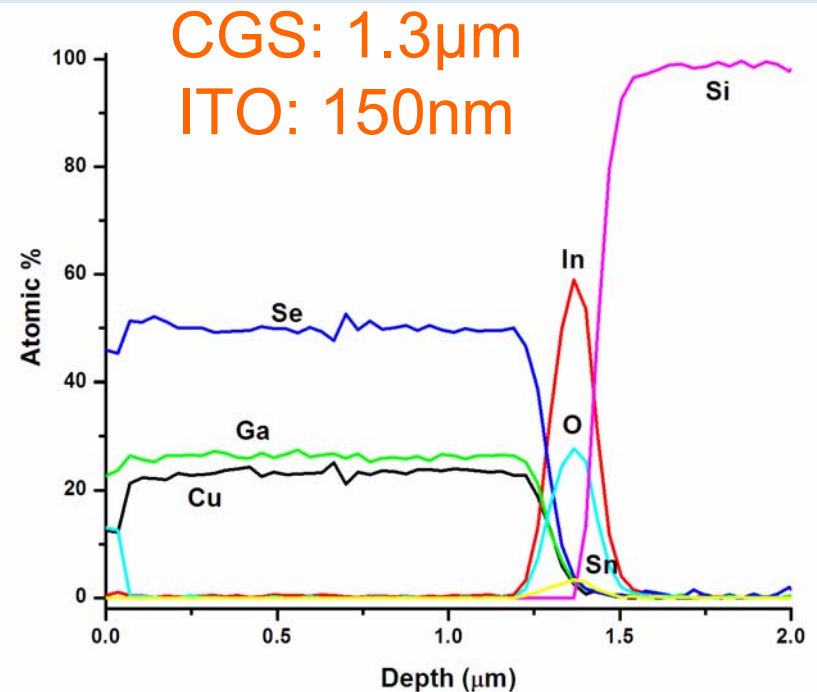
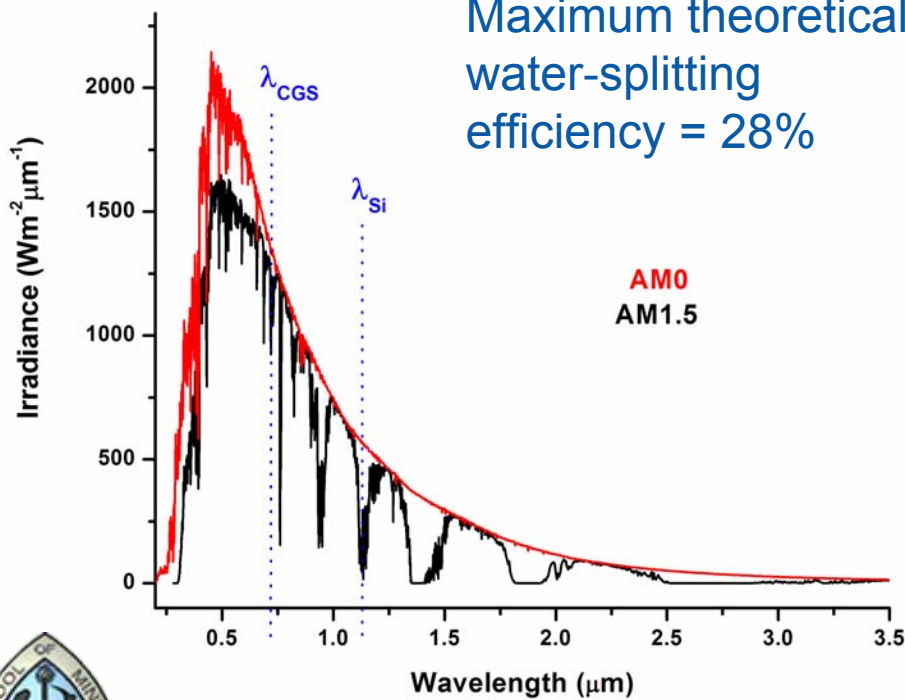

# Electrodeposited CGS - Deposition of Ga Difficult

## Deposition Bath Compositions Have Been Developed To Produce Good Quality Films

Chalcopyrite Structure

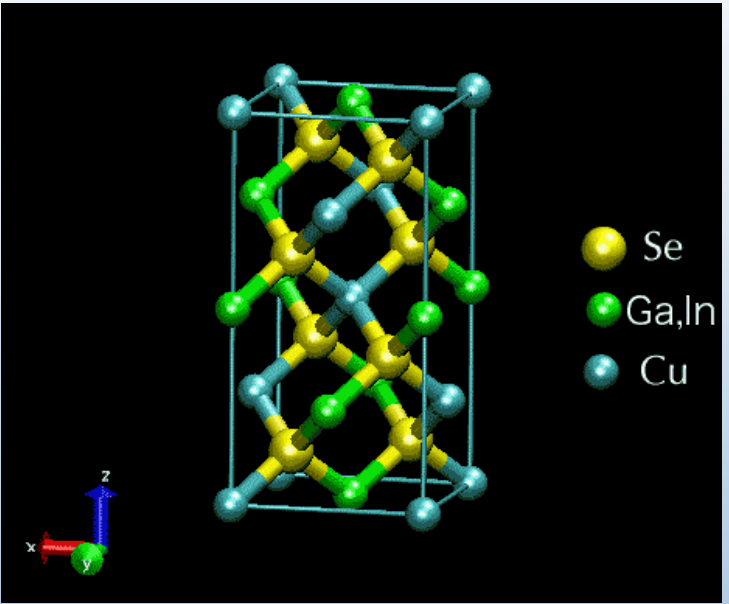

**CuGaSe<sub>2</sub> (CGS)**

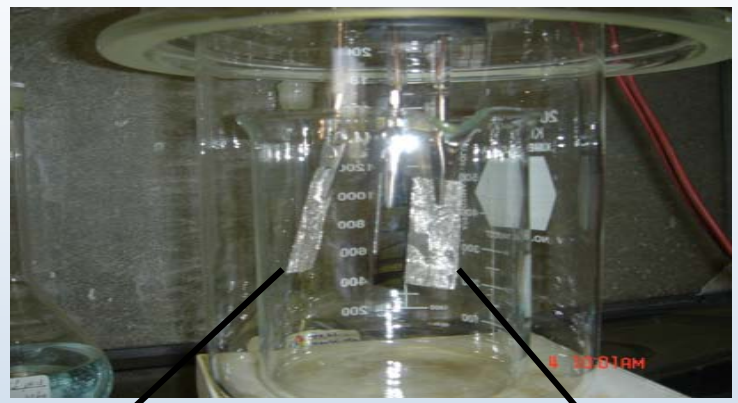

Fair quality electrodeposited CGS film on Mo substrate



Good quality electrodeposited CIGS film on Mo substrate

# Conclusions

- III-V nitrides
  - Higher nitrogen content realized with In as lattice expander
  - PEC water splitting demonstrated on GaInPN:Si tandem cell
  - Nitrogen enhanced stability, but nitrides grown by MOCVD have poor performance
  - p+ layer field aided charge collection, increased efficiency
  - Nitride epilayer needs improvement
- CIGSSe thin films
  - Theoretical 23% water-splitting efficiency with Si-CuGaSe<sub>2</sub> tandem cell, but configuration difficult to realize
  - Possible to electrodeposit good quality films with high Ga
  - Annealing system is being constructed and trials will soon be underway

# Future Plans

- Remainder of FY 2007:
  - Continue understanding and improving nitride-based material: III-V nitrides and SiN
  - Develop new electrosynthesis approaches and low-temperature annealing processes for CIGSSe films
  - Improve tandem cell design with thin-film CIGSSe
- For FY 2008:
  - Look at possible new materials with UNLV, CSM ...
  - Coatings: SiN, SiC ...
  - Multijunction structures