

# **System Level Analysis of Hydrogen Storage Options**

**R. K. Ahluwalia, T. Q. Hua, J. K. Peng and R. Kumar**

**2010 DOE Hydrogen Program Review**

**Washington, DC**

**June 8-11, 2010**

**Project ID: ST001**

This presentation does not contain any proprietary, confidential, or otherwise restricted information.

# Overview

---

## Timeline

- Project start date: Oct 2009
- Project end date: Sep 2014
- Percent complete: 20%

## Budget

- FY10: \$700 K
- FY09: \$960 K

## Barriers

- H<sub>2</sub> Storage Barriers Addressed:
  - A: System Weight and Volume
  - B: System Cost
  - C: Efficiency
  - E: Charging/Discharging Rates
  - J: Thermal Management
  - K: System Life-Cycle Assessments

## Partners/Interactions

- FreedomCAR and Fuel Partnership
- Storage Systems Analysis Working Group, MH COE, CH COE
- BMW, Caltech, Ford, GM, LANL, LLNL, TIAX, Lincoln Composites, SCI, UTC, and other industry

# Objectives and Relevance

---

- Perform independent systems analysis for DOE
  - Provide input for go/no-go decisions
- Provide results to CoEs for assessment of performance targets and goals
  - Address all aspects of on-board and off-board storage targets including capacity, charge/discharge rates, GHG emissions, safety, and cost
- Model and analyze various developmental hydrogen storage systems
  - On-board system analysis
  - Off-board regeneration
  - Reverse engineering
- Identify interface issues and opportunities, and data needs for technology development



# Approach

---

- Develop thermodynamic and kinetic models of processes in physical, complex metal hydride, sorbent, and chemical hydrogen storage systems
  - Select rigor of analysis to resolve system-level issues, conduct trade-off analysis and provide fundamental understanding of system/material behavior
- Calibrate, validate and evaluate models
- Work closely with the DOE Contractors, CoEs, Storage Tech Team, other developers, and Storage Systems Analysis Working Group (SSAWG)
- Assess improvements needed in materials properties and system configurations to achieve H<sub>2</sub> storage targets
- Organize monthly SSAWG calls and communicate results and discuss work plans



# Collaborations

cH2	Lincoln Composites, Quantum, SCI
CcH2	BMW, LLNL, SCI
Metal Hydrides	BNL, UH/UB, UTC
Chemical Hydrides	APCI, CHCoE (LANL/UPenn)
Sorbents	HSCoE (NREL), SWRI®
GHG Emissions	ANL (GREET)
Off-Board Regeneration	MHCoE (BNL, SRNL), CHCoE (LANL, PNNL)
Off-Board Cost	ANL (H2A Group), ANL (HDSAM)
On-Board Cost	TIAX
SSAWG	CHCoE, HSCoE, HSECoE, MHCoE, DOE, OEMs, Tank Manufactures, TIAX

- Argonne develops the storage system configuration, determines performance, identifies and sizes components, and provides this information to TIAX for high-volume manufacturing cost estimation

# Technical Accomplishments

- Systems analyzed or updated in FY2010
  - Physical storage: cH<sub>2</sub>, CcH<sub>2</sub>, LH<sub>2</sub>
  - Sorption storage: MOF-177, AC
  - Chemical storage: AB/IL
- Systems are at different stages of development and have been analyzed to different levels of sophistication
  - Results are constantly updated

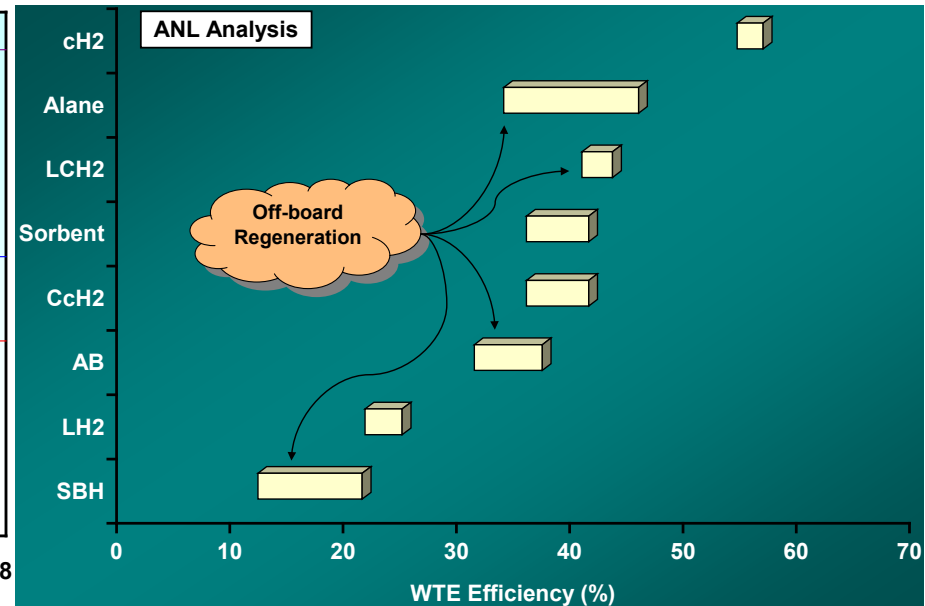
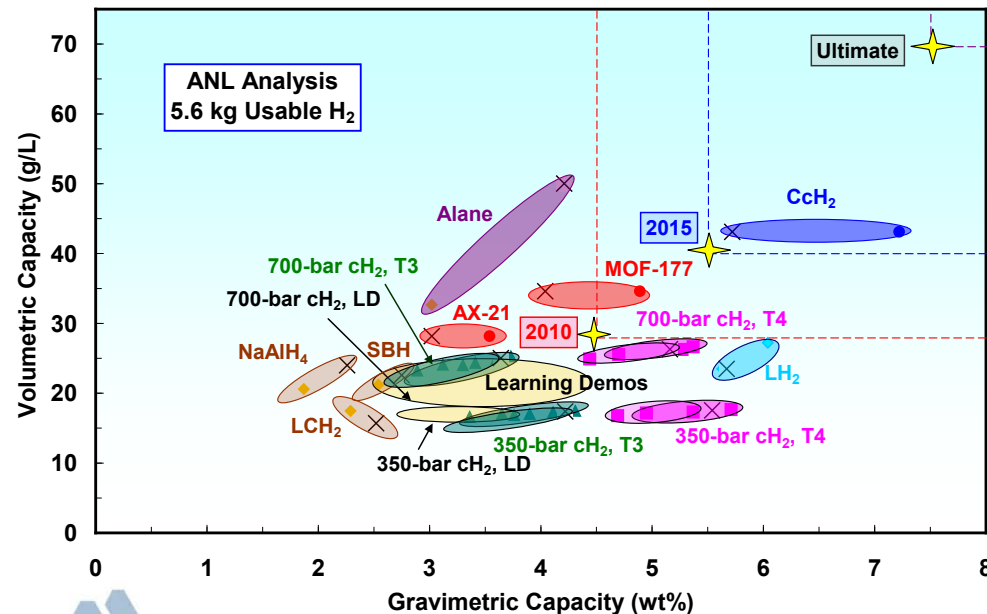

# System Analysis of Physical Storage Systems

---

- Benedict-Webb-Rubin equation of State: REFPROP coupled to GCtool
- Carbon Fiber Netting Analysis
  - Algorithm for optimal dome shape with geodesic winding pattern (i.e., along iso-tensoids)
  - Algorithm for geodesic and hoop windings in cylindrical section
- Fatigue Analysis of Type 3 Tanks
  - Algorithm for residual compressive stresses introduced by auto-fretting, pre- and post-proof load distribution between liner and CF
  - Unloading of residual stresses under cryogenic conditions
  - S/N curves for Al 6061-T6 alloy, non-zero mean stresses
  - 5500 pressure cycles at 1.25 NWP (SAE J2579)
- Dynamic models for gaseous/liquid refueling, discharge, dormancy
- Models for off-board analysis
  - FCHtool and GREET for greenhouse gas emissions
  - H2A for pathway analysis
  - HDSAM for scenario analysis



# Compressed H<sub>2</sub> Storage in Type 3 and Type 4 Tanks

- Type 3 Tanks
  - For cost and weight reasons, shift the load to carbon fiber
  - Maximum load share in CF limited to 90% because of liner fatigue life and constraint on proof pressure
  - Type 3 tank may not be appropriate for service at 700 bar
- Type 4 Tanks (Single-tank design)
  - Higher volumetric but lower gravimetric capacity at 700 bar
  - CF requirement function of translation efficiency, safety factor and variability of fiber strength at high volume manufacturing

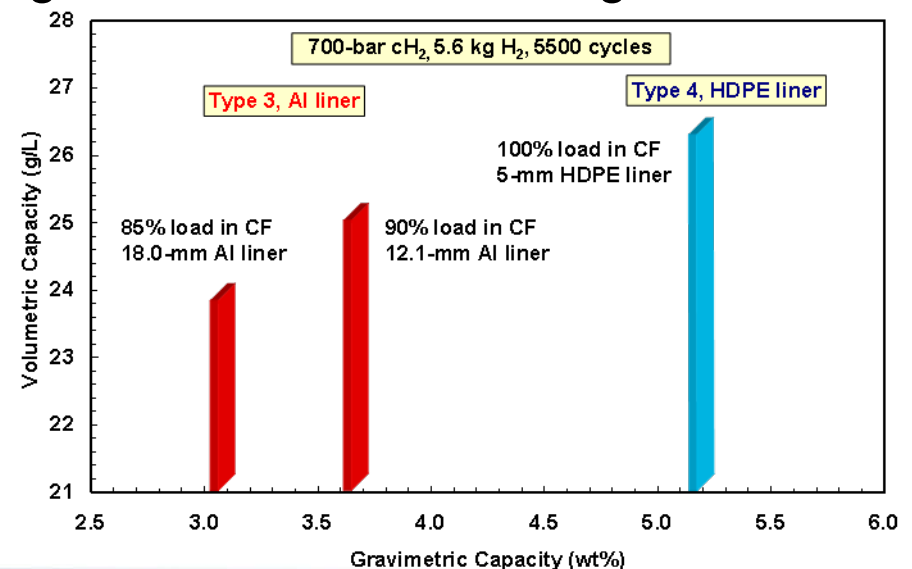
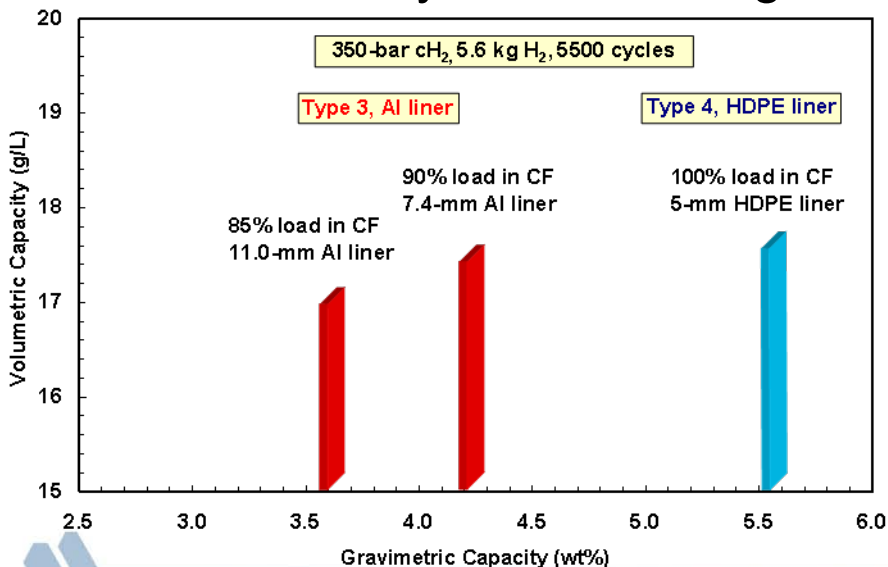



# Cryo-Compressed H<sub>2</sub> Storage

- LLNL Gen-3 System Configuration
  - Reduced insulation, Better packaging, Vacuum valve box eliminated
  - In-tank heat exchanger, 4000-psi pressure vessel rating
- Projected capacity of the scaled 5.6-kg system meets 2015 targets
  - Single vs. double flow nozzle, liquid H<sub>2</sub> pump
  - Gravimetric capacity > 9% with aluminum shell but higher cost
  - Maximum CF load share limited to 85% at cryogenic T, 276 bar

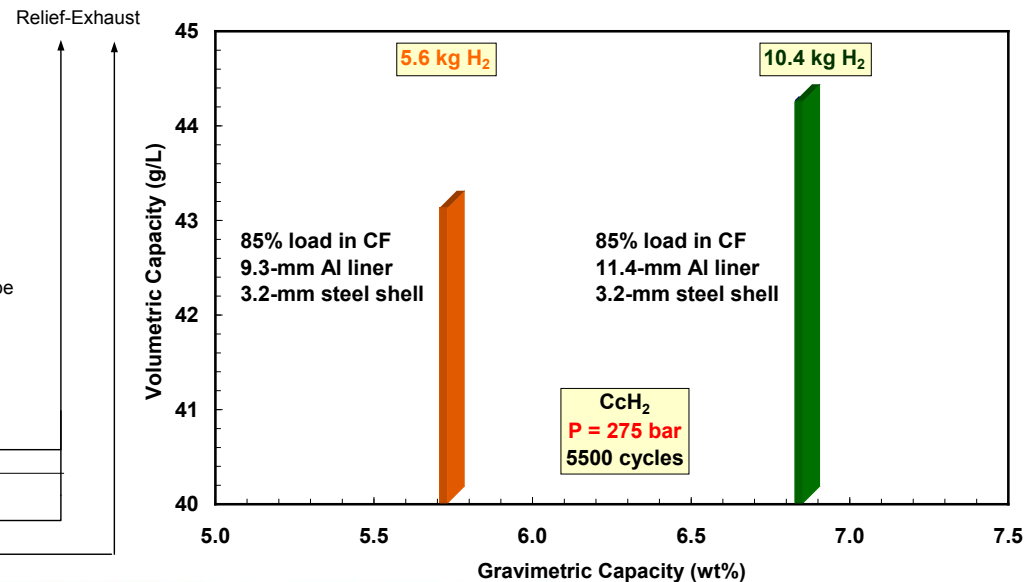
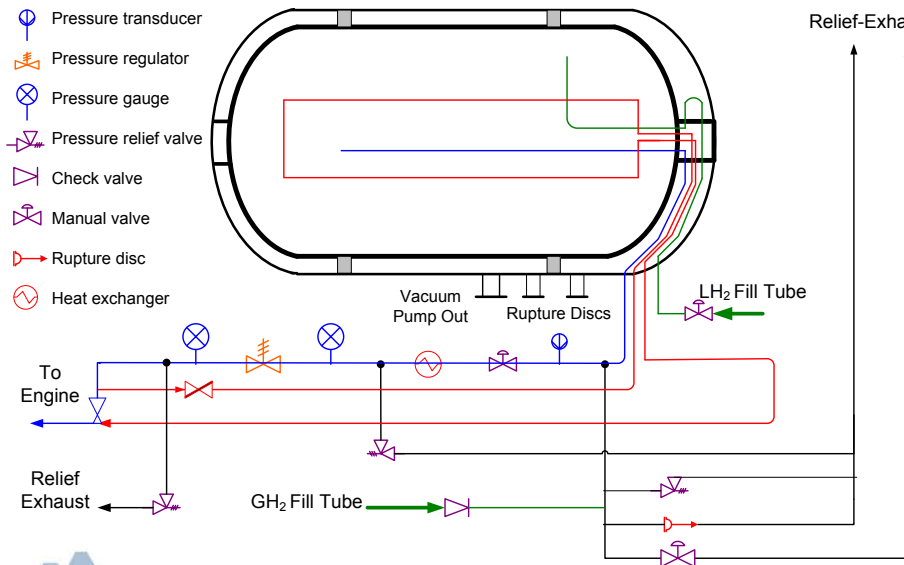

# Charge and Discharge Behavior

- Storage capacity is a function of initial temperature
  - Can store 6.4 kg usable  $H_2$  (80.8 g/L) starting from 50 K, 4 atm
- Heat supplied during discharge to maintain 4-atm minimum P
  - 2.3 MJ for 34.3 K initial T, 6.4 kg stored  $H_2$

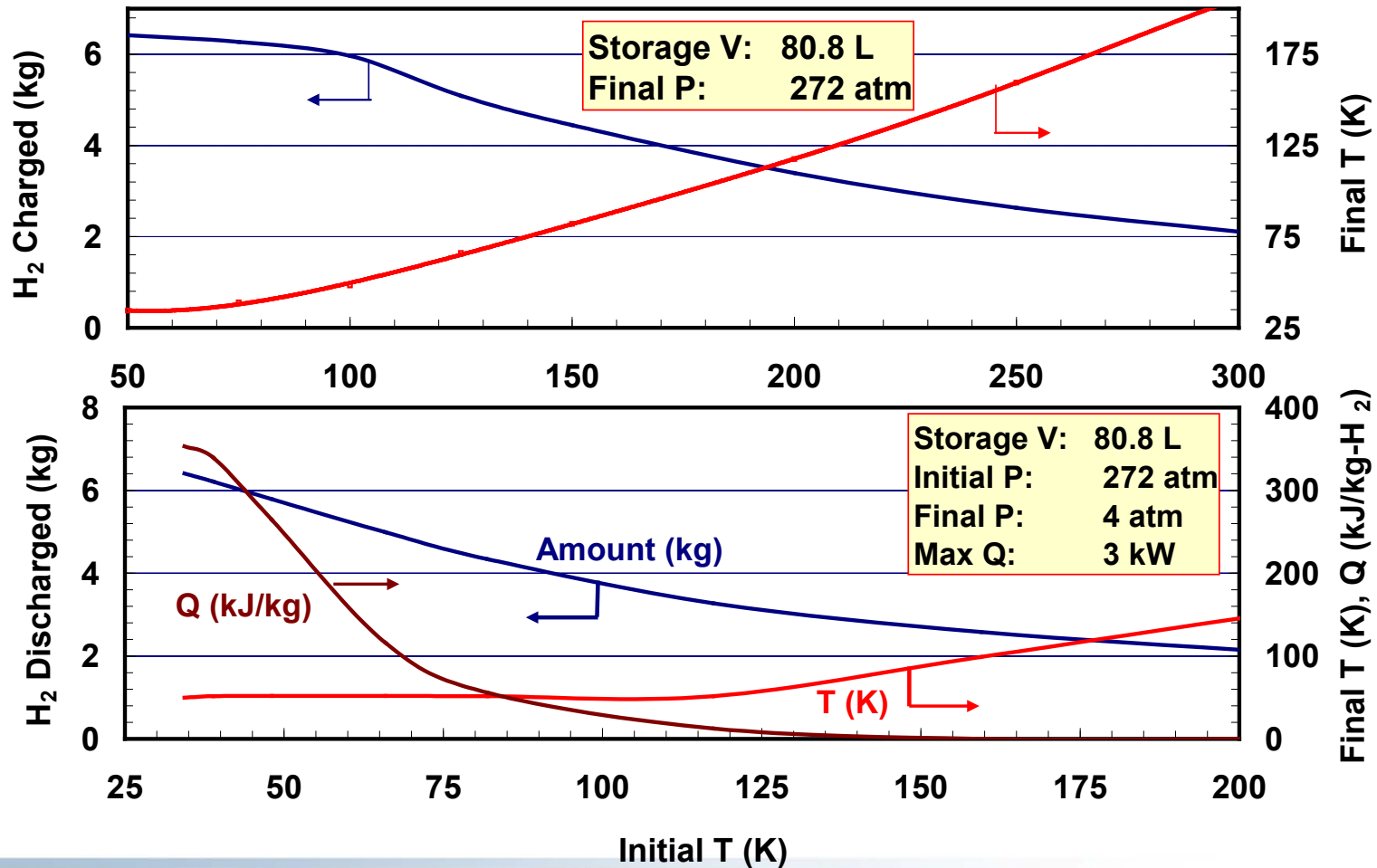

# Dormancy and Hydrogen Loss Rate

- No loss of hydrogen after tank reaches 323 K, tank 30% full
- Difficult to always meet the targets of 0.1/0.05 g/h/kg-H<sub>2</sub> with 5 W reference heat in-leakage rate
- No H<sub>2</sub> loss with minimal daily driving (LLNL work)

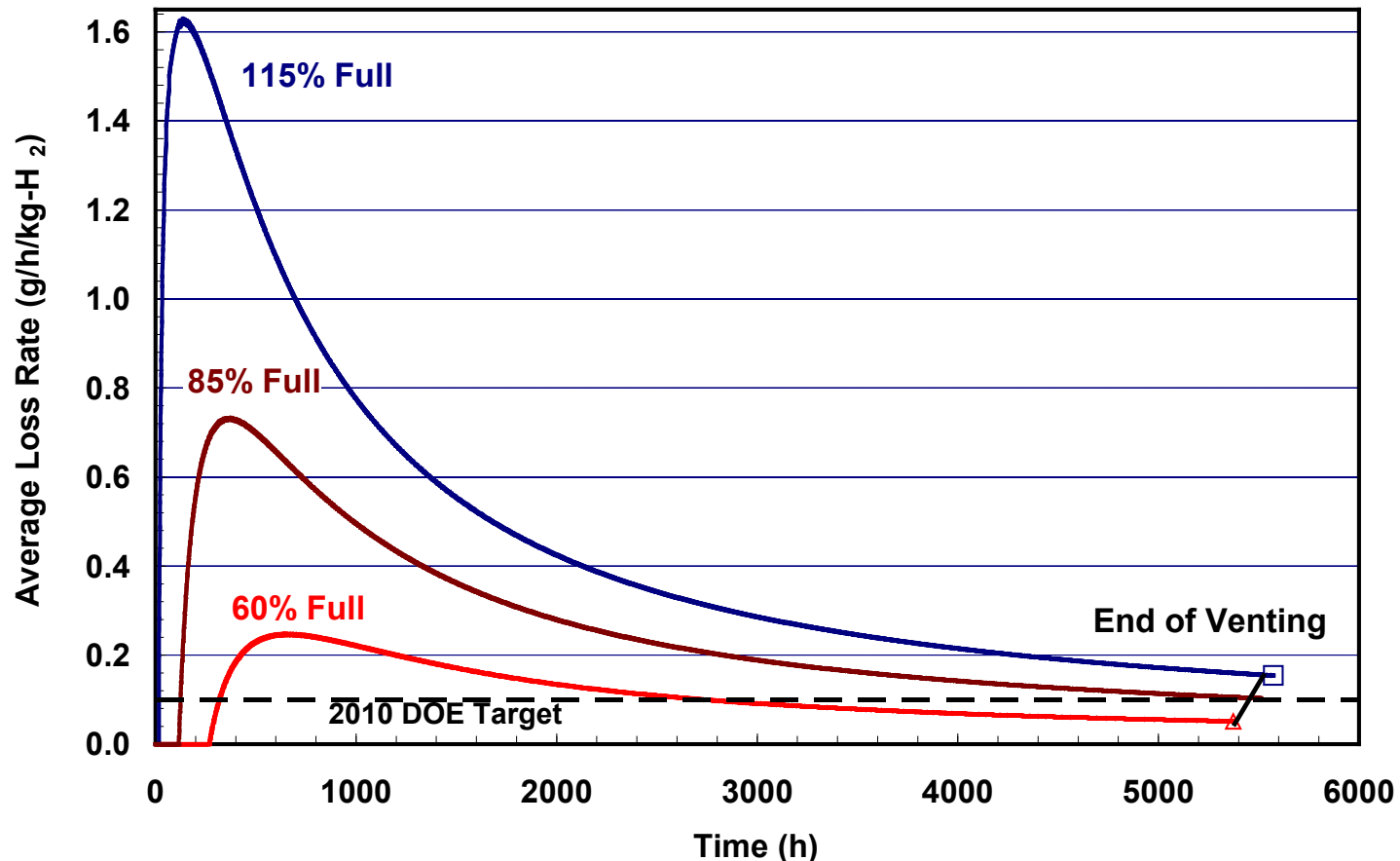

# Hydrogen Storage in Metal Organic Frameworks

## Adiabatic Liquid H<sub>2</sub> Refueling

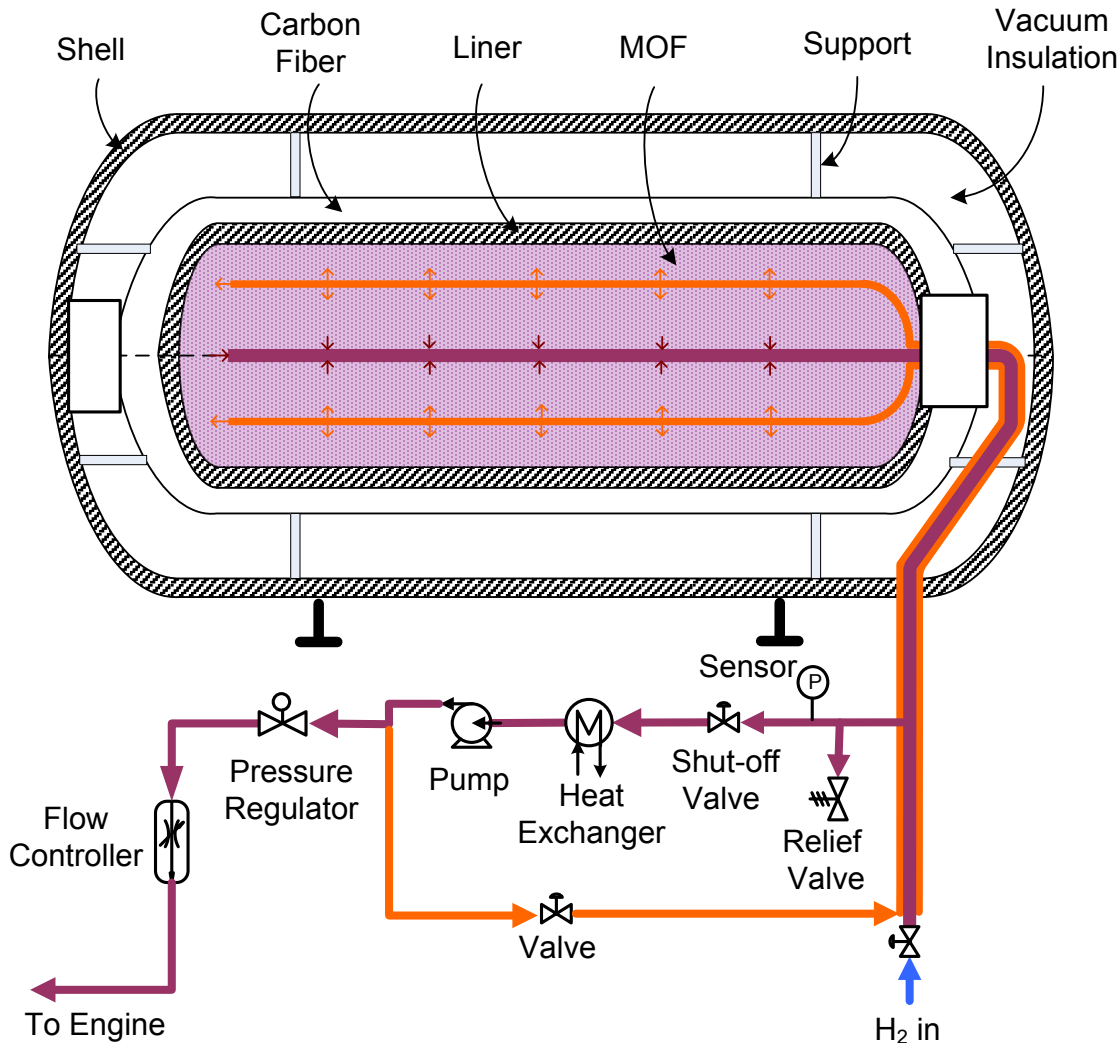

### Key System Requirements

#### Storage Medium

- 5.6 kg recoverable H<sub>2</sub>
- 4-bar minimum delivery P
- MOF-177, 0.6 packing fraction

#### Type-3 Containment Vessel

- 2.25 safety factor
- 5,500 P and T cycles
- Toray 2550 MPa CF
- Al 6061-T6 alloy liner

#### Heat Transfer System

- 1.5 kg/min H<sub>2</sub> refueling rate
- 1.6 g/s H<sub>2</sub> min flow rate
- 1.3 W radiative in-leakage

# System Storage Capacity – Optimum P & T

- System gravimetric capacity peaks at ~150 atm but the volumetric capacity increases slowly with storage pressure

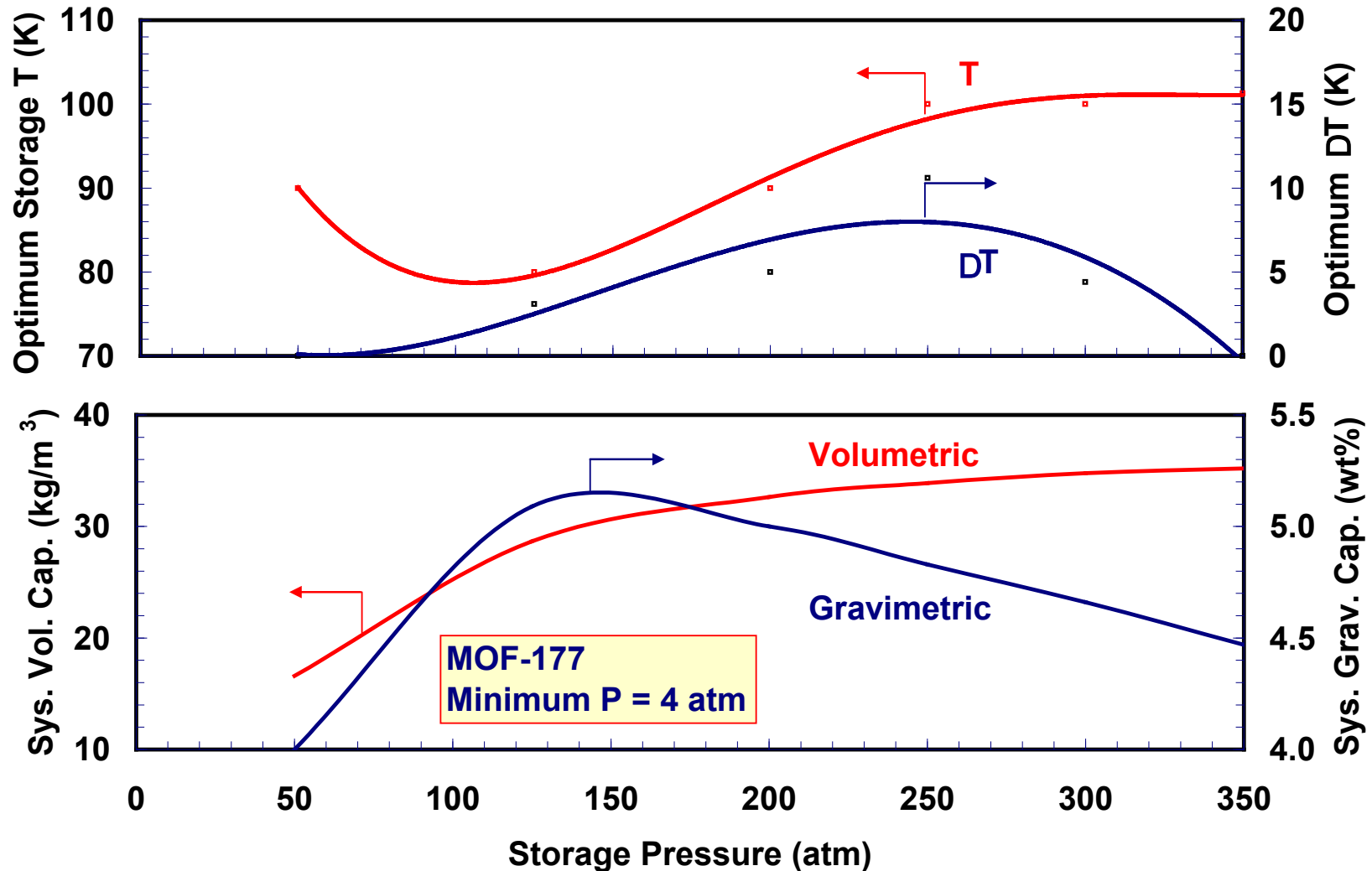

# Refueling/Discharge Dynamics and Dormancy

- Refueling: 7.1 MJ evaporative cooling load
  - 62% for  $\Delta H$ , 38% for sensible cooling and PV work
- Discharge options
  - Constant Q (1.2 kJ/g of  $H_2$  discharged), 1.9 kW
  - Variable Q, heat supplied only if tank P < 4 atm, 6.3-kW peak Q
- Dormancy: Function of amount of  $H_2$  stored and P/T at start of the event
  - Minimum dormancy is 16 W.d (2.8 days at 5 W in-leakage rate)
  - Peak  $H_2$  vent rate is 1 g/h/W (4.8 g/h at 5 W in-leakage rate)

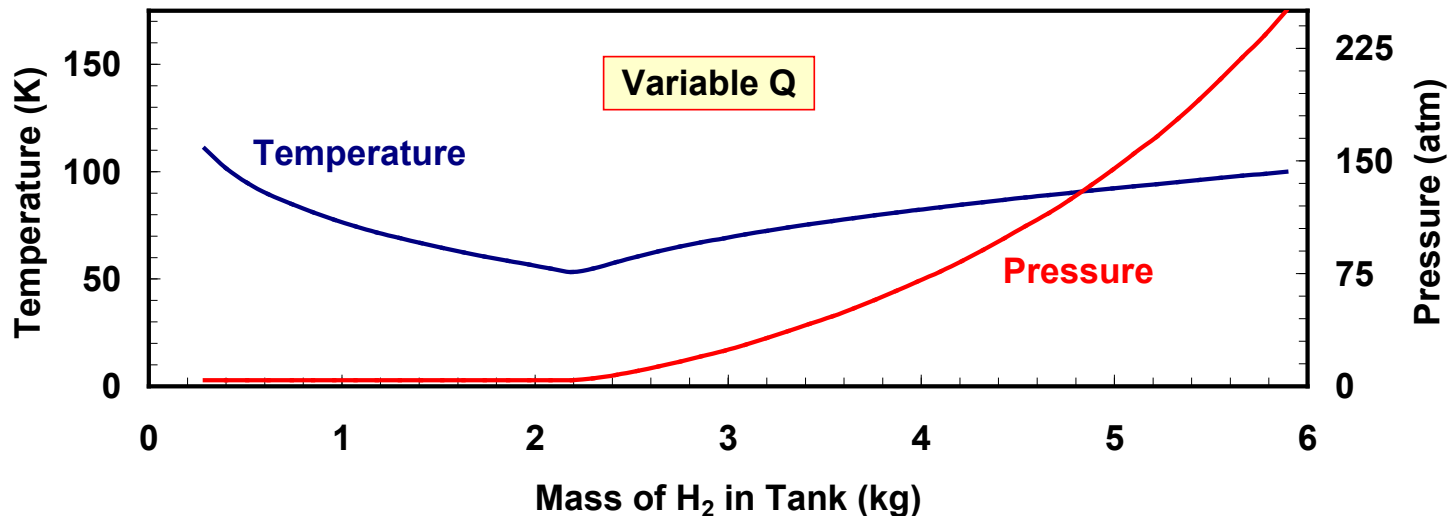

# Cold Gas Storage

- Gravimetric capacity suffers at high pressures and low temperatures
- At low pressures, liquid H<sub>2</sub> may be needed to reach the storage temperatures required for target volumetric capacity
- Difficult to match 2015 targets without liquid H<sub>2</sub> infrastructure

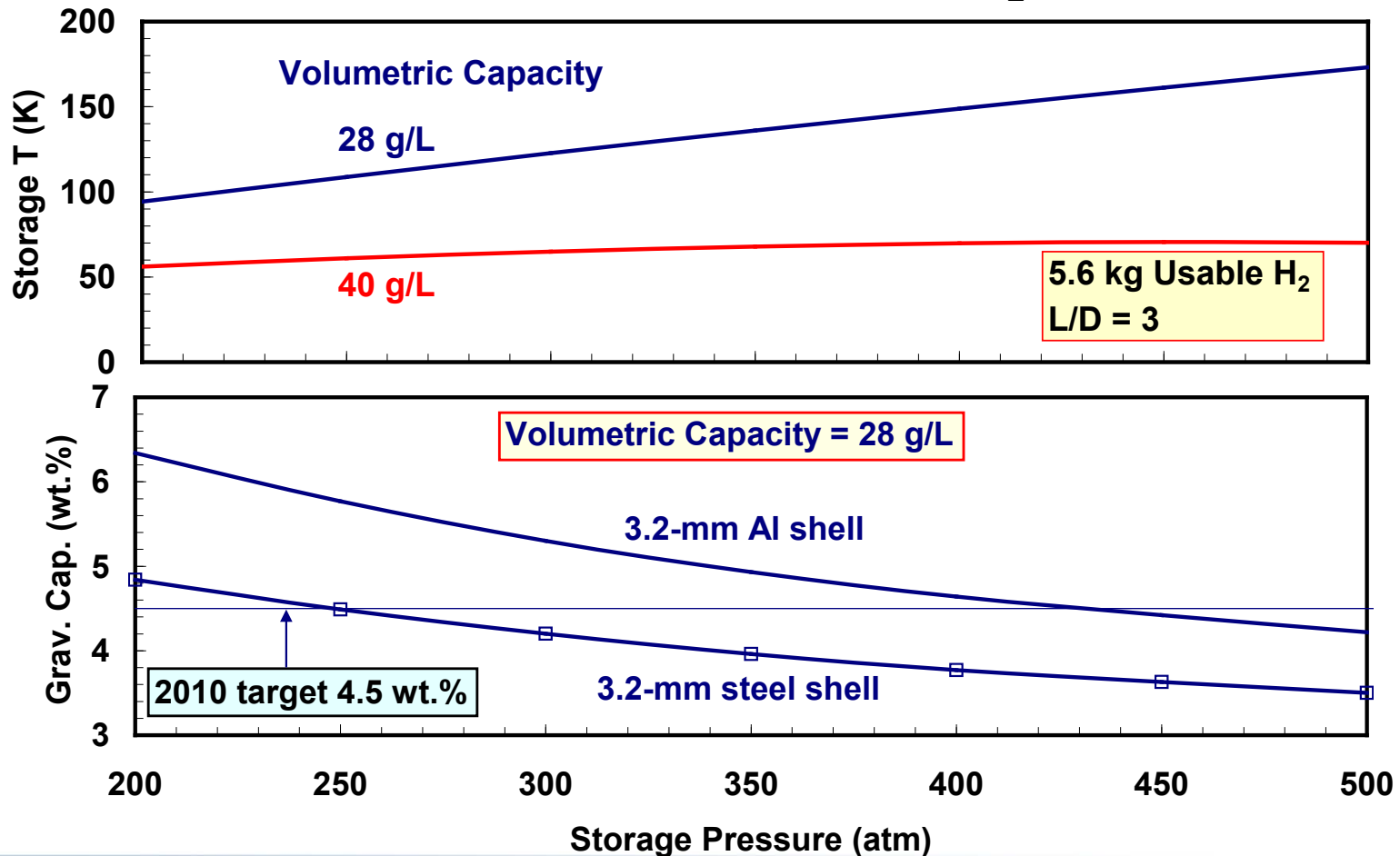

# Hydrogen Storage using Ammonia Borane in Ionic Liquids – Preliminary Results

- Work at UPenn has shown that 1.1 H<sub>2</sub>-equiv are released in 5 min and 2.2 H<sub>2</sub>-equiv in 20 min from 50:50 wt% AB/bmimCl at 110°C

	Unit	Value	Comments/Source
<b>AB</b>			
Molecular weight		30.9	
H <sub>2</sub> content	wt. %	19.6	
Melting point	°C	110 - 114	E. Mayer, Inorg. Chem., 12, 1954–1955, 1973
Density	kg/m <sup>3</sup>	780	
Thermal stability and decomposition	°C	90 -110 150°C >450°C	1 <sup>st</sup> H <sub>2</sub> -equiv released, >1 h induction period for release at 85°C 2 <sup>nd</sup> H <sub>2</sub> -equiv released 3rd H <sub>2</sub> -equiv released
DH	kJ/mol-H <sub>2</sub>	21	Exothermic reaction
<b>Solvent: 1-butyl-3-methylimidazolium chloride (bmimCl)</b>			
Molecular weight		174.7	
Melting point	°C	70	BASF
Flash point	°C	192	BASF
Density	kg/m <sup>3</sup>	1050	at 80°C, BASF
Viscosity	Pa-s	0.147	at 80°C, BASF
Specific heat	kJ/kg-K	1.81	at 80°C, BASF
Thermal stability	°C	?	
<b>50:50 wt% AB/bmimCl</b>			
H <sub>2</sub> content	wt. %	9.9	Himmelberger et al, Inorg. Chem., 48, 9883-9889, 2009
Melting point	°C	NA	Liquid at room temperature
Density	kg/m <sup>3</sup>	NA	
Viscosity	Pa-s	NA	Stirrable liquid at room temperature
Specific heat	kJ/kg-K	NA	
Thermal stability and decomposition	°C	NA	Foams once H <sub>2</sub> is released; foam begins to convert to white solid after releasing 1 H <sub>2</sub> -equiv; entire mixture becomes solid after releasing 2 H <sub>2</sub> -equiv; no induction period for H <sub>2</sub> release.
DH	kJ/mol-H <sub>2</sub>	33	Exothermic reaction



# Dehydrogenation Kinetics: 50:50-wt% AB in bmimCl

- Avrami-Erofeyev fits to rates derived from UPenn cumulative release data
- Need  $T > 150^\circ\text{C}$  for 67 mEq/s average release rate if 2 H<sub>2</sub>-equiv are to be released in 30 s, 120 h<sup>-1</sup> liquid hourly space velocity (LHSV)

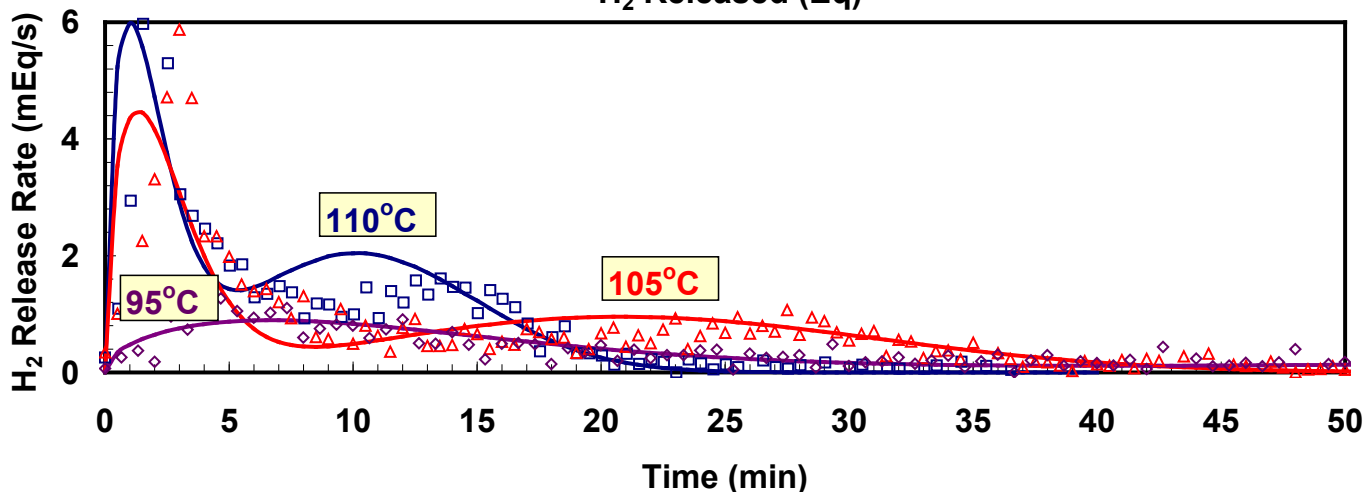
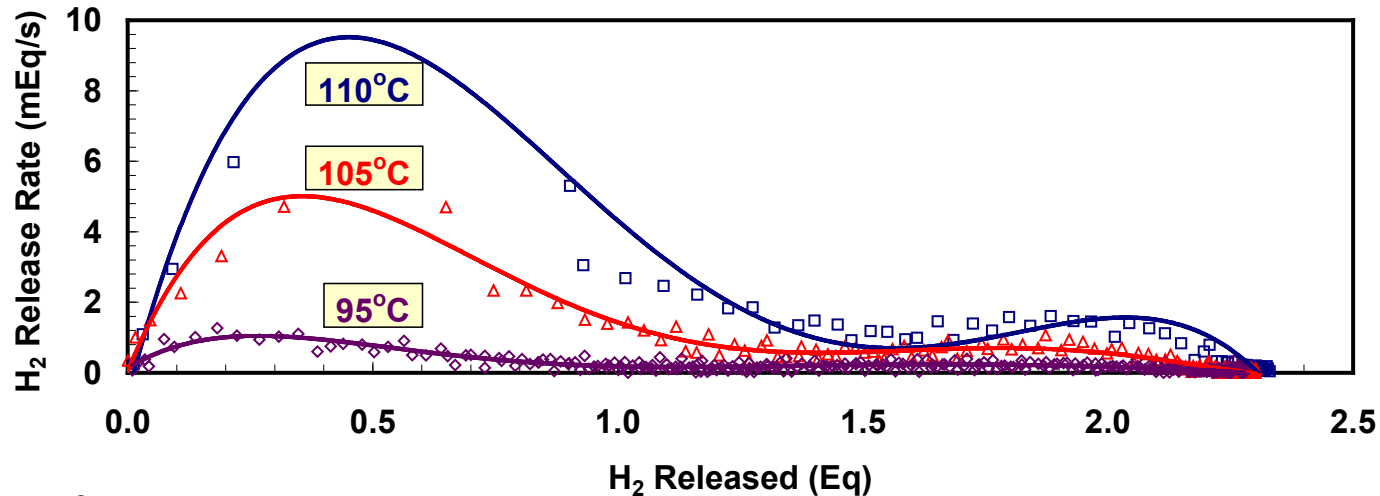

# Dehydrogenation Reactor Performance

- Main challenge: control peak T and AB conversion using heat transfer and product recycle (R: recycle ratio)
  - Adiabatic T rise in excess of 500°C ( $\Delta T_{ad} = 295N_{H_2}$ )
- Difficult to control the peak temperature by heat transfer
- Inverse relationship between peak temperature and inlet temperature
- $R < 0.95$  for 100% conversion (2.2 H<sub>2</sub>-Eq) at 150°C T, 150 h<sup>-1</sup> LHSV
- $R > 0.8$  to limit maximum temperature to 250°C

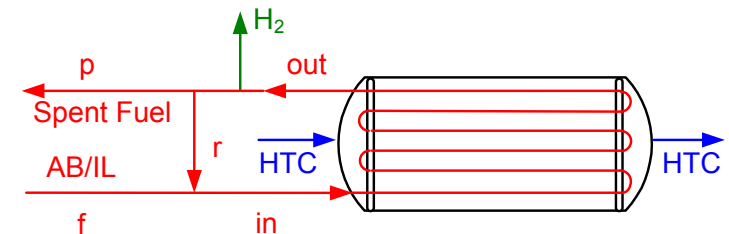
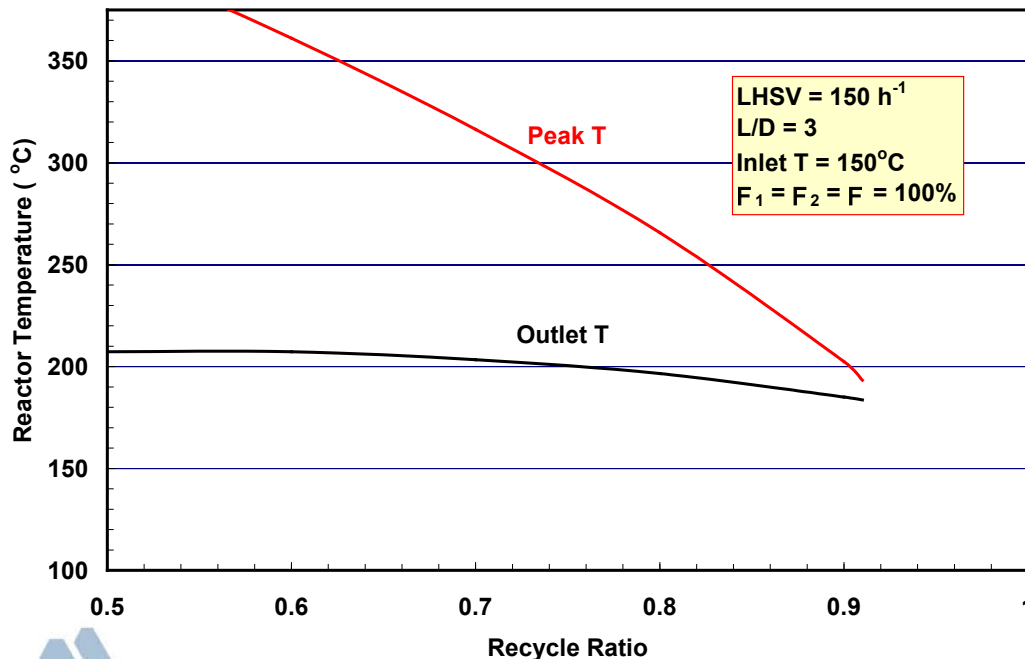

- AB flow rate adjusted for 1.6 g/s of H<sub>2</sub> at 100% conversion
- Coolant (ethylene glycol) flow rate adjusted for 10°C  $\Delta T$  with 26.4 kW heat transfer

# Adiabatic Operation of Reactor

- The 100% conversion line determines the maximum recycle ratio as a function of the inlet temperature
- Lower peak temperature if the reactor is operated adiabatically: 275°C vs. >320°C with cooling (125°C inlet T)
- Simpler reactor design but 100% of the heat of reaction has to be removed elsewhere in the system

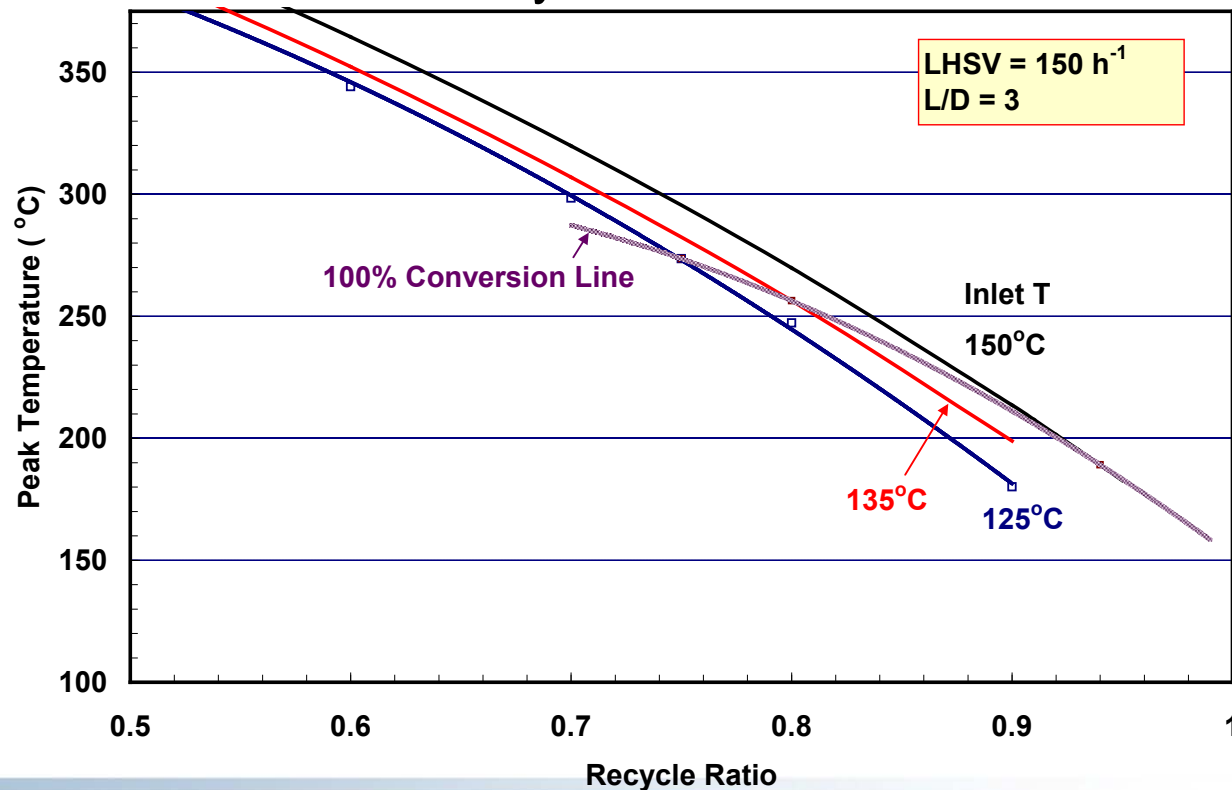

# On-board System Configuration

- Volume exchange tank design for storing fresh and spent fuel
- Adiabatic vs. non-adiabatic dehydrogenation reactor
- Buffer hydrogen tank
- Heat transfer system (FCS HT and LT coolants)
- Gas liquid separator (coalescing filter)
- Startup heater (electrical)

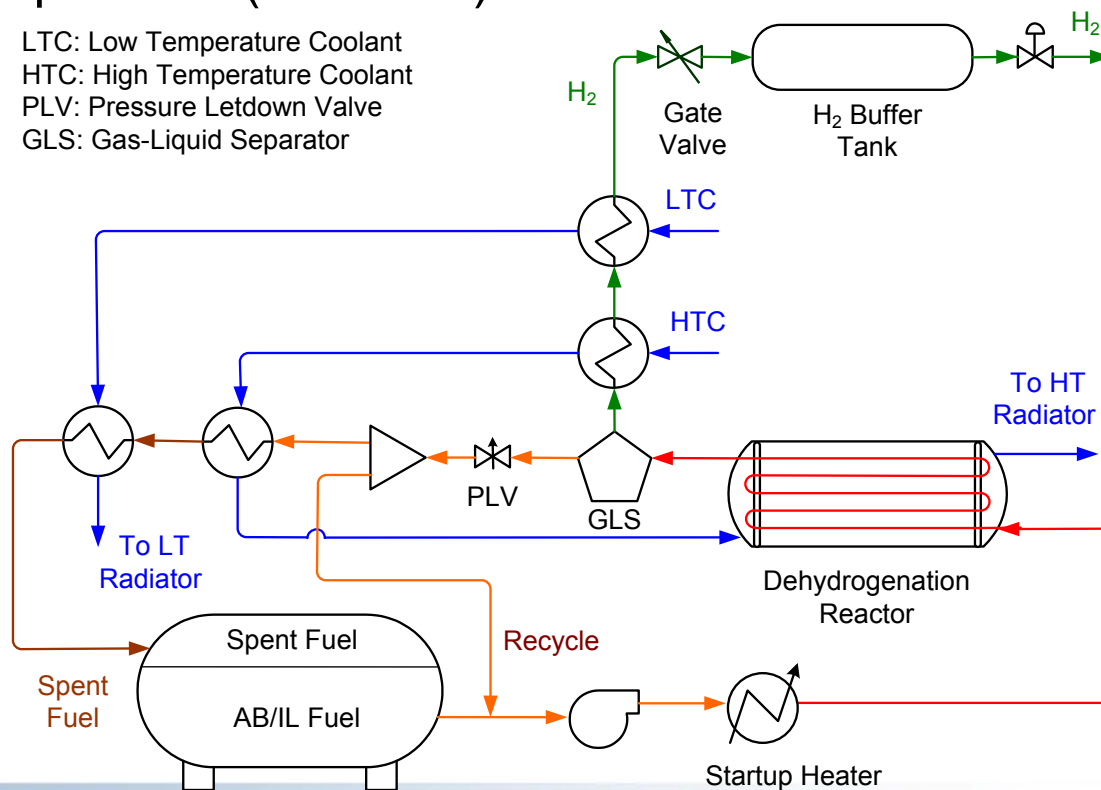

# Summary and Status

- Results given as single data points, consult references for range, sensitivity and background
- Metrics cover all DOE targets for on-board and off-board storage
- Some results vetted, others for developmental materials and processes
- Providing quantitative results for kinetics and thermodynamics of sorption & desorption and hydrogenation & dehydrogenation, usable & recoverable H<sub>2</sub>, cyclic material behavior, on-board & off-board heat transfer, GHG emissions, regeneration pathways and efficiencies, and fuel and ownership cost

Performance and Cost Metric	Units	cH2 350-bar	cH2 700-bar	LH2	CcH2	MOF-177	2010 Targets	2015 Targets	Ultimate Targets
Usable Storage Capacity (Nominal)	kg-H <sub>2</sub>	5.6	5.6	5.6	5.6	5.6			
Usable Storage Capacity (Maximum)	kg-H <sub>2</sub>	5.6	5.6	5.6	6.6	5.6			
System Gravimetric Capacity	wt%	5.5	5.2	5.6	5.5-9.2	4.0	4.5	5.5	7.5
System Volumetric Capacity	kg-H <sub>2</sub> /m <sup>3</sup>	17.6	26.3	23.5	41.8-44.7	34.6	28	40	70
Storage System Cost	\$/kWh	13.4	20	TBD	12	18	4	2	TBD
Fuel Cost	\$/gge	4.2	4.3	TBD	4.80	4.6	2-3	2-3	2-3
Cycle Life (1/4 tank to Full)	Cycles	NA	NA	NA	5500	5500	1000	1500	1500
Minimum Delivery Pressure, FC/ICE	atm	4	4	4	3-4	4	4/35	3/35	3/35
System Fill Rate	kg-H <sub>2</sub> /min	1.5-2	1.5-2	1.5-2	1.5-2	1.5-2	1.2	1.5	2.0
Minimum Dormancy (Full Tank)	W-d	NA	NA	2	4-30	2.8			
H <sub>2</sub> Loss Rate (Maximum)	g/h/kg-H <sub>2</sub>	NA	NA	8	0.2-1.6	0.9	0.1	0.05	0.05
WTT Efficiency	%	56.5	54.2	22.3	41.1	41.1	60	60	60
GHG Emissions (CO <sub>2</sub> eq)	kg/kg-H <sub>2</sub>	14.0	14.8	TBD	19.7	19.7			
Ownership Cost	\$/mile	0.12	0.15	TBD	0.12	0.15			

# Future Work

---

As lead for Storage System Analysis Working Group, continue to work with DOE contractors and CoEs to model, validate and analyze various developmental hydrogen storage systems.

## Physical Storage

- Multi-tank compressed H<sub>2</sub> tank system
- Advanced cryo-compressed storage concepts

## Metal Hydrides

- Update of alane slurry storage system analysis
- Regeneration of alane/other off-board regenerable metal hydrides
- Reversible metal-hydride storage system

## Sorbent Storage

- Analysis of generic sorbent system with arbitrary heat of adsorption

## Chemical Hydrogen

- On-board system for AB/IL class of materials (LANL collaboration)
- Fuel cycle efficiency of AB regeneration (PNNL/LANL collaboration)
- Advanced reactor concepts for organic liquid carriers

# Supplemental Slides



# On-Board Performance: Key Assumptions

	Parameter	Reference Values
<b>Sorbent</b>	<b>MOF-177</b>	J. Mater. Chem., 2007, 17, 3197-3204
	Skeletal density	1534 kg/m <sup>3</sup>
	Crystallographic density	427 kg/m <sup>3</sup> (1.56 cm <sup>3</sup> /g pore volume)
	Bulk density	256 kg/m <sup>3</sup> (0.6 packing fraction)
	Thermal conductivity	0.3 W/m.K
<b>Insulation</b>	<b>Multi-Layer Vac. Super Insulation</b>	Aluminized Mylar sheets, Dacron spacer
	Layer density	28 cm <sup>-1</sup>
	Density	59.3 kg/m <sup>3</sup>
	Pressure	10 <sup>-5</sup> torr
	Effective conductivity	5.2x10 <sup>-4</sup> W/m.K
<b>Tank</b>	<b>T700S Carbon Fiber</b>	Toray Carbon Fiber
	Tensile strength	2550 MPa
	Density	1600 kg/m <sup>3</sup>
	L/D	2
	Liner	Al 6061-T6 alloy, 5500 PT cycles, 125% NWP
	Shell	3.2-mm thick Al 6061-T6 alloy
<b>Refueling</b>	<b>Adiabatic Refueling with LH<sub>2</sub></b>	
	Storage temperature	Function of storage pressure
	Temperature swing	Function of storage temperature
<b>Discharge</b>	<b>H<sub>2</sub> Recirculation</b>	
	Temperature rise	150 K
	Recirculation rate	TBD
<b>System</b>	Miscellaneous weight	16 kg
	Miscellaneous volume	10 L



# Modeled Hydrogen Adsorption Isotherms

- H Furukawa, M Miller, M Yaghi (J. Mater. Chem. 2007, 3197 – 3204)
  - MOF-177,  $Zn_4O(1,3,5\text{-benzenetribenzoate})$  crystals
  - Peak 75 g-H<sub>2</sub>/kg surface excess at 77 K, 70 atm; 110 g/kg absolute
- Low-T data fitted to Dubinin-Astakhov (D-A) isotherm with  $m=2.5$ 
  - Derived  $\Delta H_a$ : 5.3 kJ/mol at  $N_a/N_{a,max} \ll 0.1$ , 2 kJ/mol at  $N_a/N_{a,max} = 0.5$
- Need temperature swing to release H<sub>2</sub> sorbed in MOF
  - At 4 atm,  $N_{ex}/N_{ex,max} = 79\%$  (50 K), 41% (77 K), 19% (100 K)

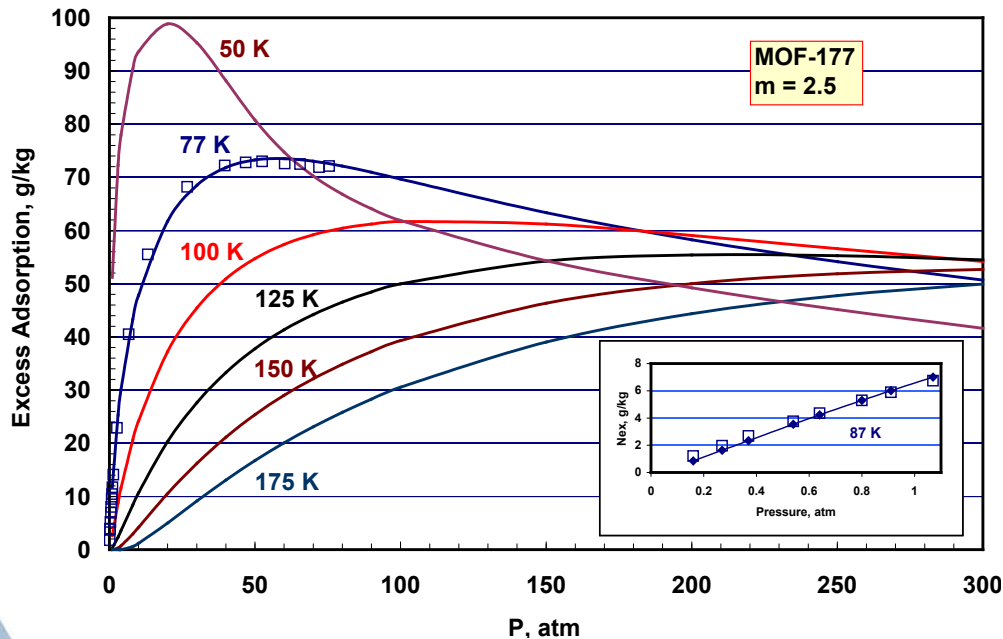

- Modeled Uptake at 100 K
- 62 g-H<sub>2</sub>/kg peak excess adsorption at 100 atm
  - 101 g-H<sub>2</sub>/kg peak absolute adsorption at 100 atm

# Adiabatic Refueling Option

- Adiabatic refueling with LH<sub>2</sub>
  - Hydrogen recirculated during discharge to provide the heat of desorption &  $\Delta T$
- Optimum storage temperature (120 K) for maximum recoverable excess adsorption capacity
  - Allowable temperature swing increases with increase in storage temperature,  $\Delta T = 0$  at 90 K
  - Excess adsorption capacity generally decreases with increase in storage temperature

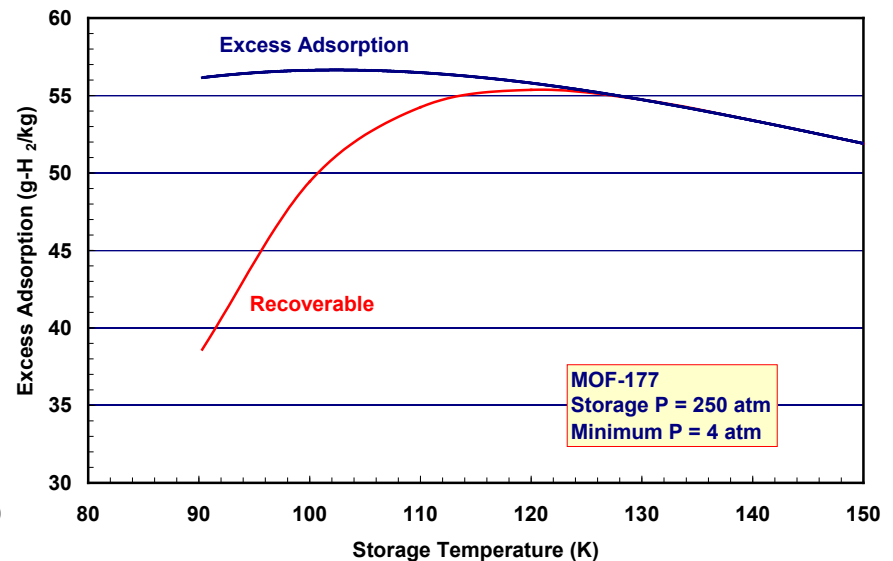
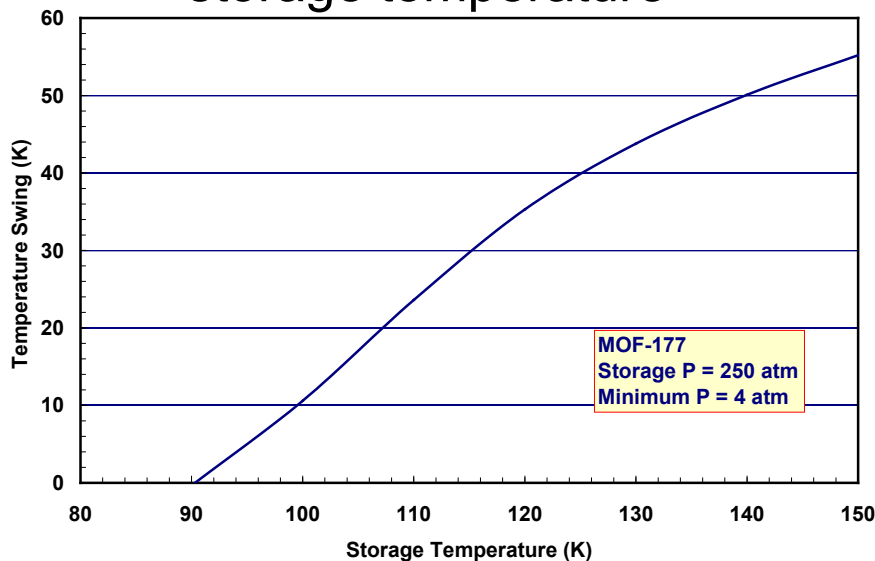

# System Storage Capacity - Optimum Temperature

- Optimum storage T (95 K) for maximum system capacity is lower than the T at which recoverable excess capacity is maximum
  - 4.8 wt% maximum system gravimetric capacity
  - 33.9 kg-H<sub>2</sub>/m<sup>3</sup> maximum system volumetric capacity

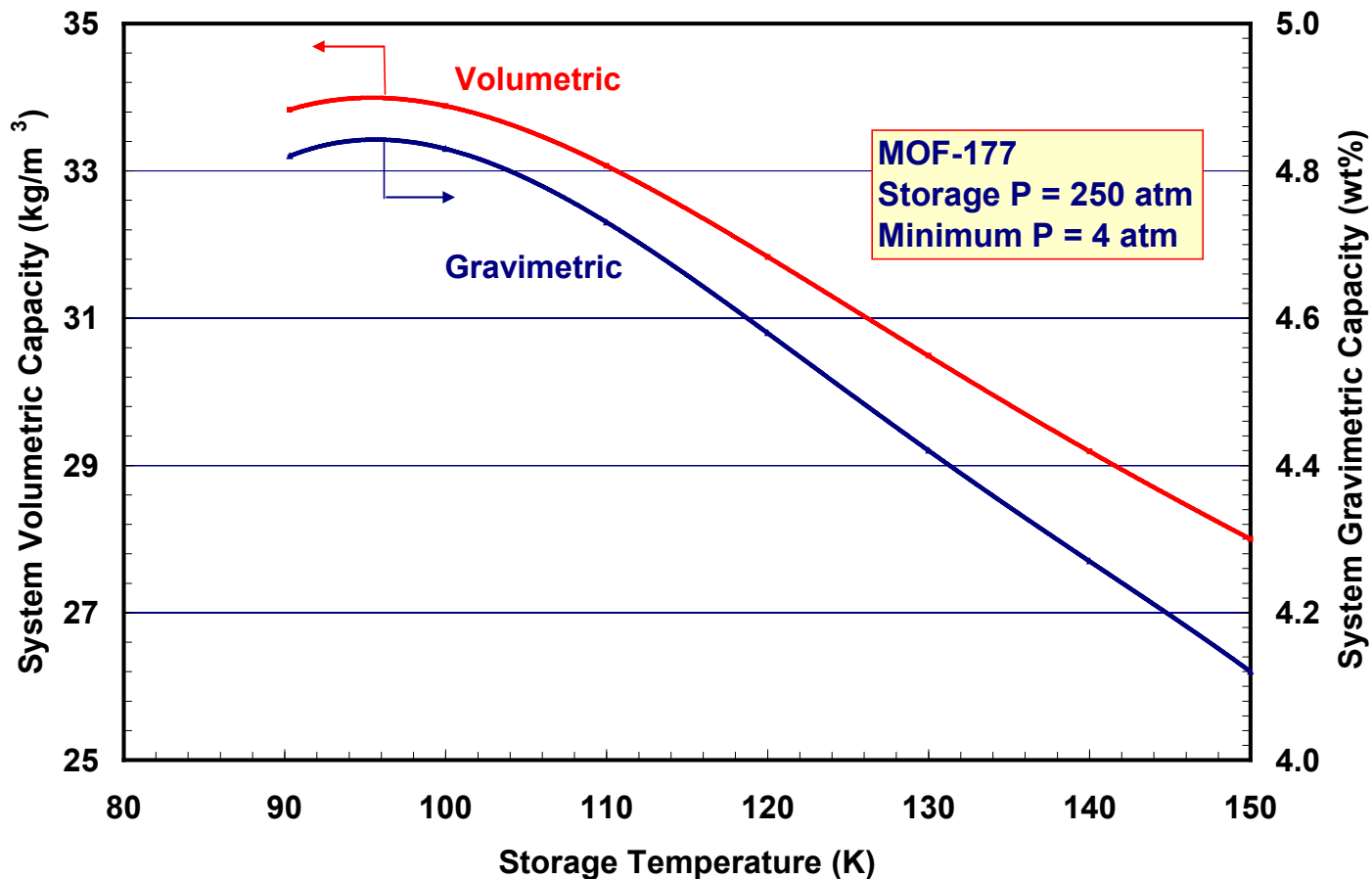

# System Storage Capacity - Optimum Pressure

- Optimum storage temperature is a function of storage pressure
- Gravimetric capacity peaks at about 150 atm storage pressure

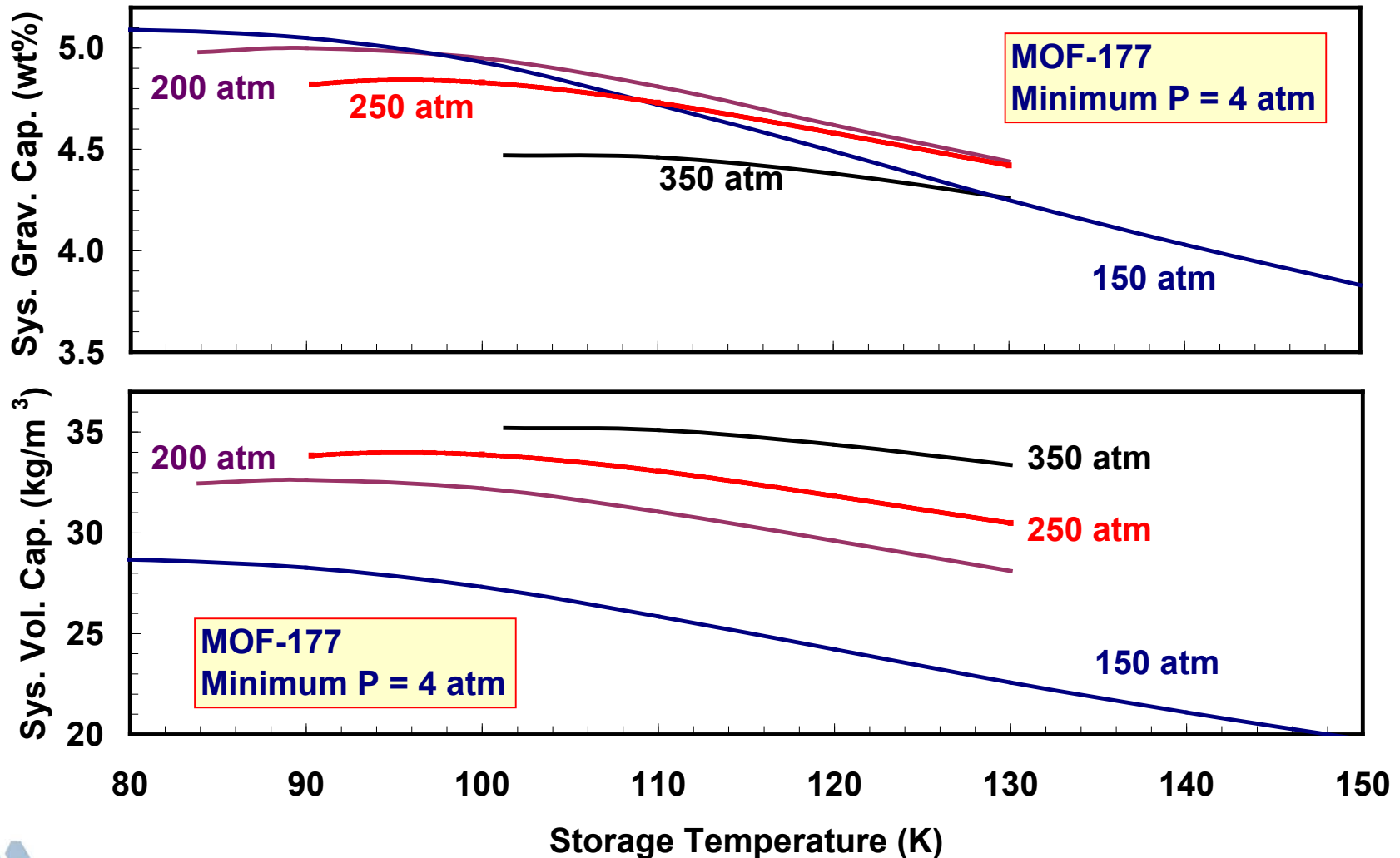

# Weight and Volume Distribution

- 4.8-wt% gravimetric and 33.9 kg/m<sup>3</sup> volumetric capacity at 250 atm
  - Medium and liner account for >50% the overall weight
  - 68% volumetric efficiency

**Weight Distribution**

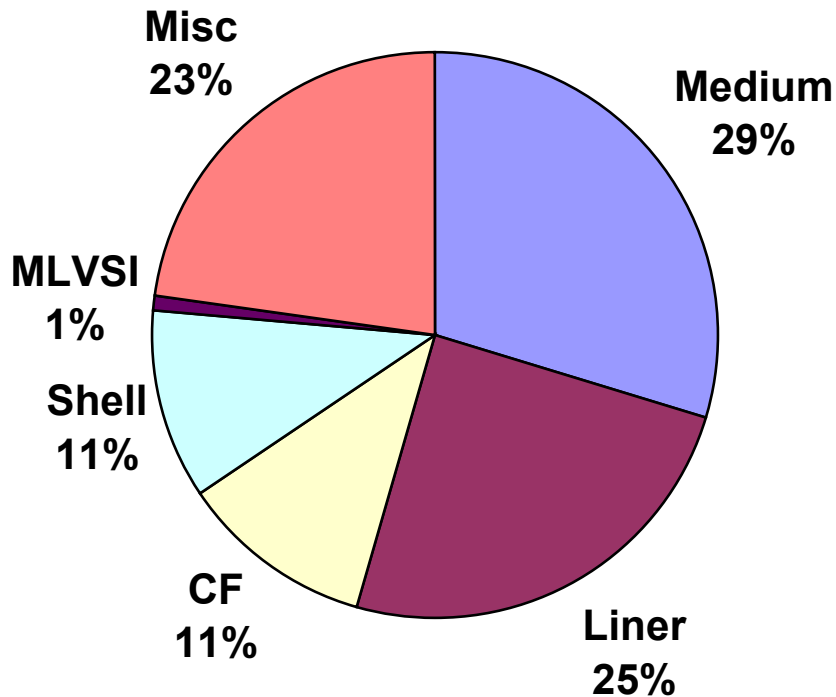

**Volume Distribution**

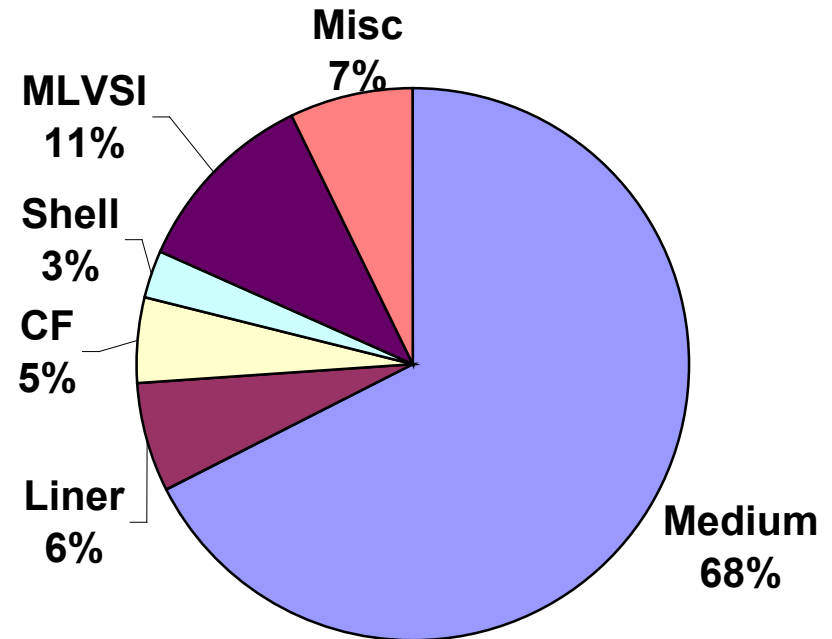

# Refueling Dynamics

- Evaporative cooling (7.1 MJ cooling load)
  - 62% of the cooling duty is due to heat of adsorption
  - 38% is due to sensible cooling of active thermal mass and PV work

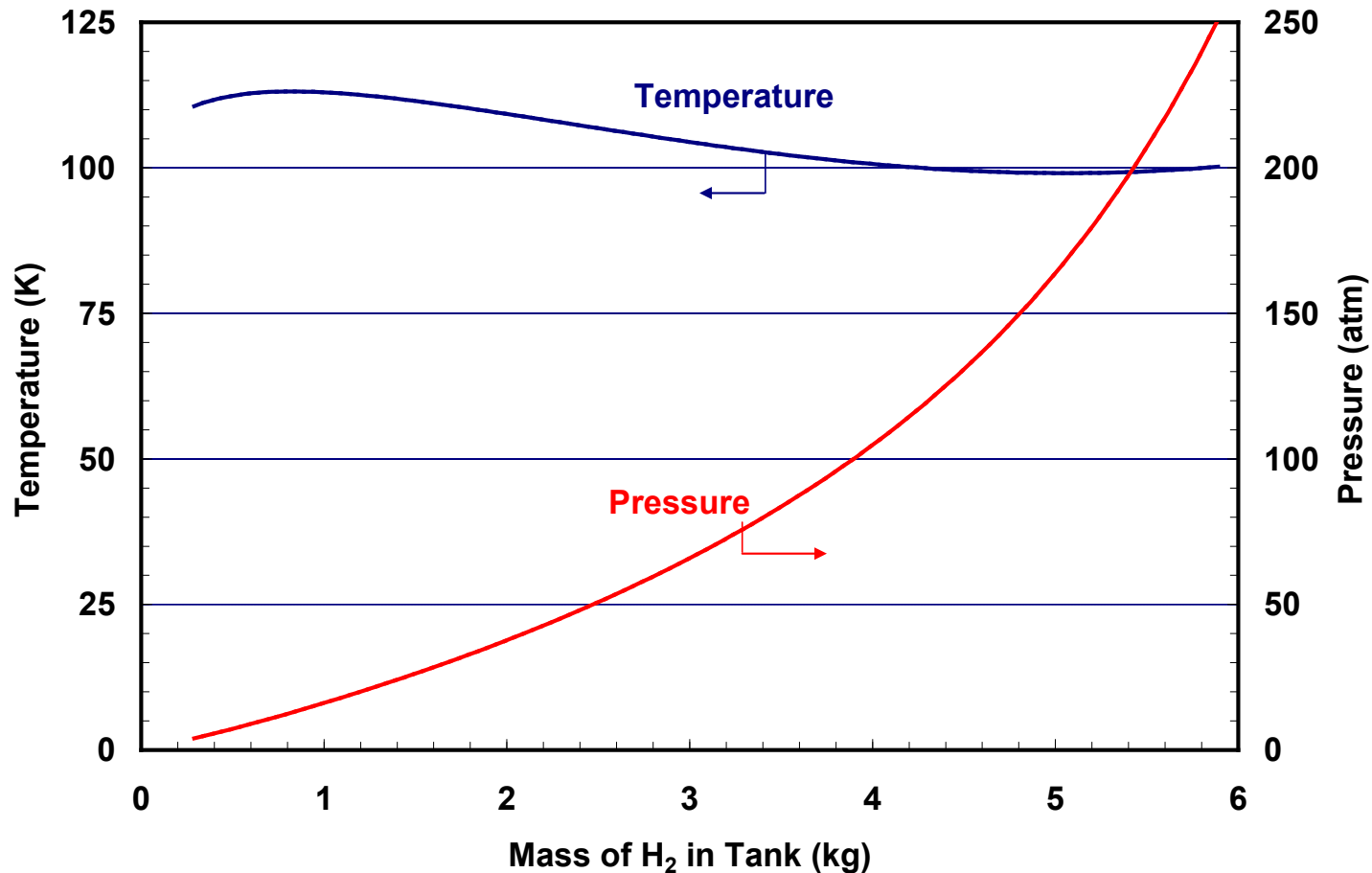

# Dormancy

- Dormancy: Function of amount of  $H_2$  stored and P/T at start of the event
  - Minimum dormancy is 16 W.d (2.8 days at 5 W in-leakage rate)
  - Peak  $H_2$  vent rate is 1 g/h/W (4.8 g/h at 5 W in-leakage rate)

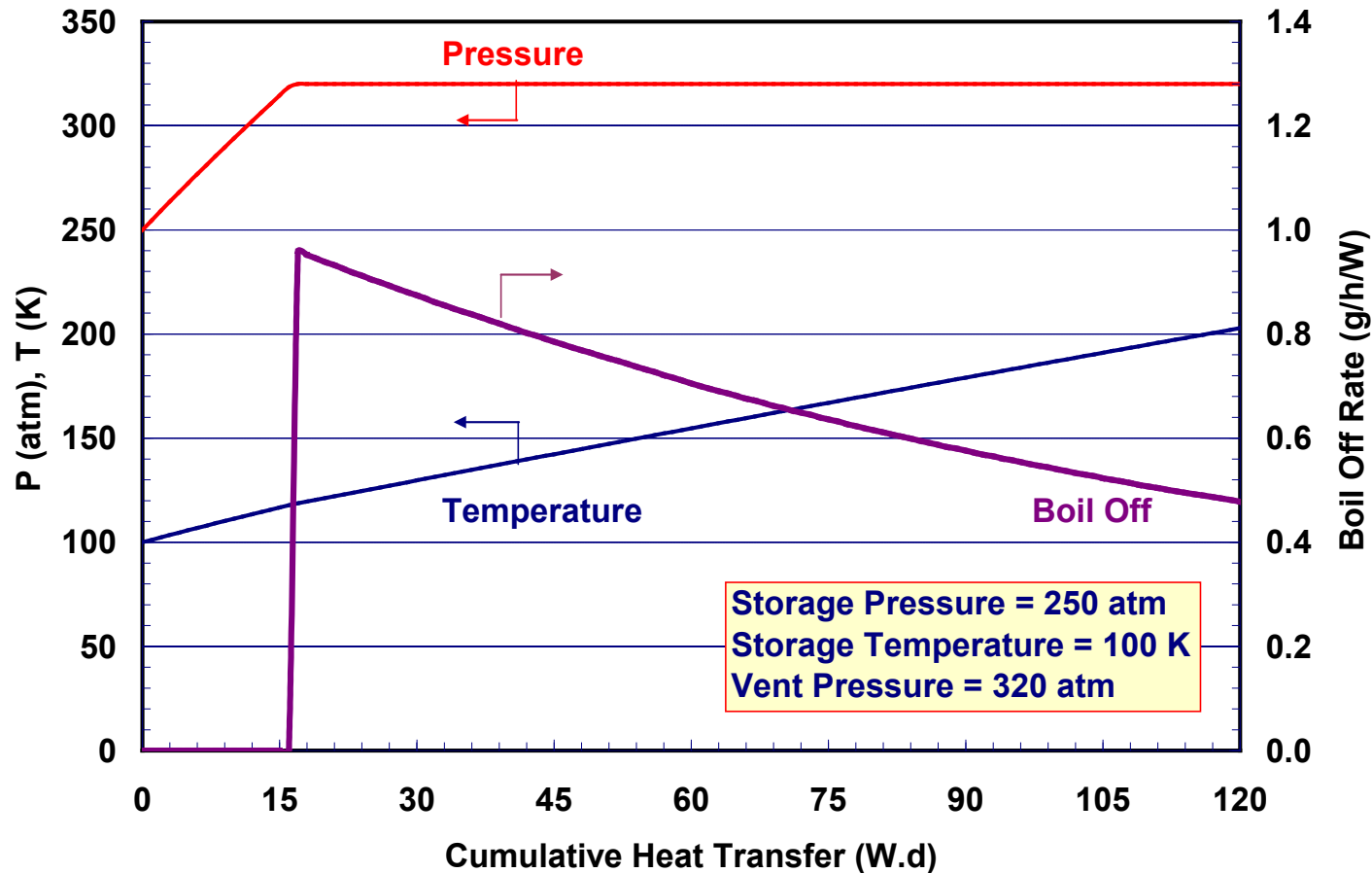

# Sensitivity Analysis

- Baseline conditions: 250 bar, 100 K, 0.6 packing fraction
- Allowable DT depends on operating conditions and decreases with increase in adsorption

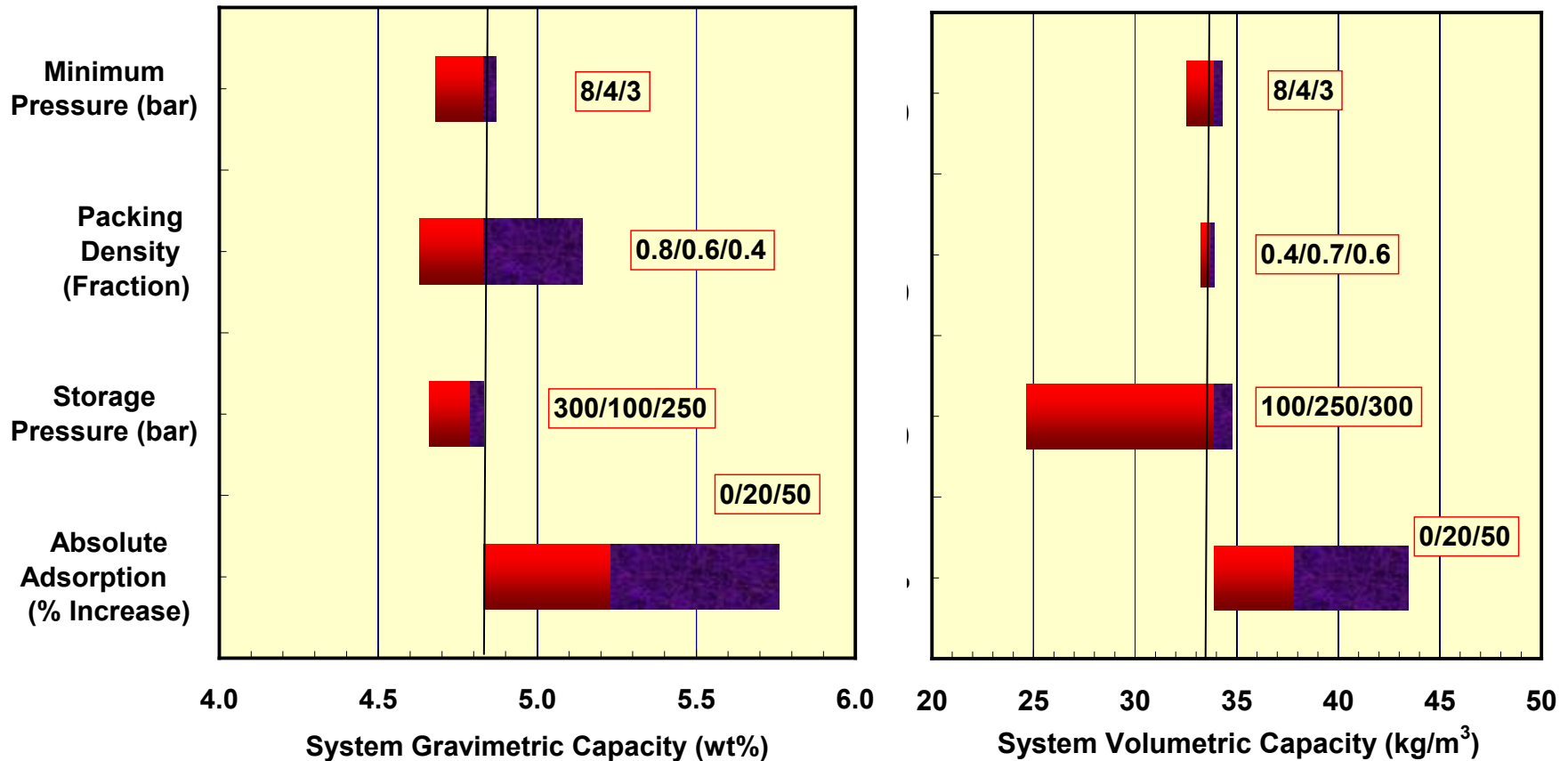



# Off-Board Performance

- Two pathways: SMR/U.S grid mix and electrolysis/renewable
- Three market penetrations: 2/15/40% (Sacramento, CA)

Process	Nominal Value	Source/Comment
<b>Production</b>		
SMR central plant capacity	341,448 kg H <sub>2</sub> /d	H2A, turnkey from Krupp-Uhde
SMR efficiency	73%	H2A
Central electrolysis, electrolyzer capacity	1046 kg H <sub>2</sub> /d	H2A
Electrolysis efficiency	74.7%	H2A
Electricity production efficiency	32.2%	EIA projected U.S. grid for 2015, inclusive of 8% transmission loss from power plant to user site
Cost of natural gas	\$0.22/Nm <sup>3</sup>	H2A
Cost of electricity	\$0.05-0.06/kWh	H2A
<b>Delivery</b>		
H <sub>2</sub> Liquefaction	8.2 kWh/kg	HDSAM, 150 tons/day liquefier
Truck capacity	4300 kg	HDSAM
Station capacity	400-1000 kg/d	2-40% market penetration, HDSAM
Boil-off losses	9.5%	HDSAM: liquefaction 0.5%, storage 0.25%/day, loading 0.5 %, unloading 2%, cryopump 3%
<b>On-board</b>		
Manufacturer/dealer markup	1.72	DOE 2008
Discount rate	15%	DOE 2008
Vehicle fuel economy	63.0 mpgge	PSAT
Annual mileage	12,000 miles	DOE 2008
<b>Regulated pollutant and GHG emissions</b>	range	GREET

# Regulated Pollutant and GHG Emissions

- Total GHG emissions = 19.7 kg/kg-H<sub>2</sub> (CO<sub>2</sub> equivalent)
  - Production: 62% (inclusive of 9.5% H<sub>2</sub> loss during on-site storage and distribution)
  - Storage: 37% (central liquefaction)
  - Distribution: <1% (truck delivery)
- g/kg-H<sub>2</sub> delivered to vehicle

Process	VOC	CO	NO <sub>x</sub>	PM <sub>10</sub>	SO <sub>x</sub>	CH <sub>4</sub>	N <sub>2</sub> O	CO <sub>2</sub>	GHG
H <sub>2</sub> Production	-	-	-	-	-	0.02	0.00	11,613	12,180
Liquefaction	0.64	1.66	10.92	9.52	24.20	9.16	0.10	6,987	7,227
Refueling Station	0.02	0.05	0.30	0.26	0.67	0.26	0.00	195	201
Truck Delivery	0.04	0.12	0.45	0.02	0.03	0.10	0.00	86	89
<b>Total:</b>	0.70	1.83	11.67	9.80	24.90	9.54	0.10	18,881	19,697



# WTT Efficiency and GHG Emissions

- 35.6-41.1% WTT efficiency, below 60% DOE target for physical storage
- GHG emissions are comparable to conventional gasoline ICEV (~0.35 kg CO<sub>2</sub>/mile, 30 mpg)

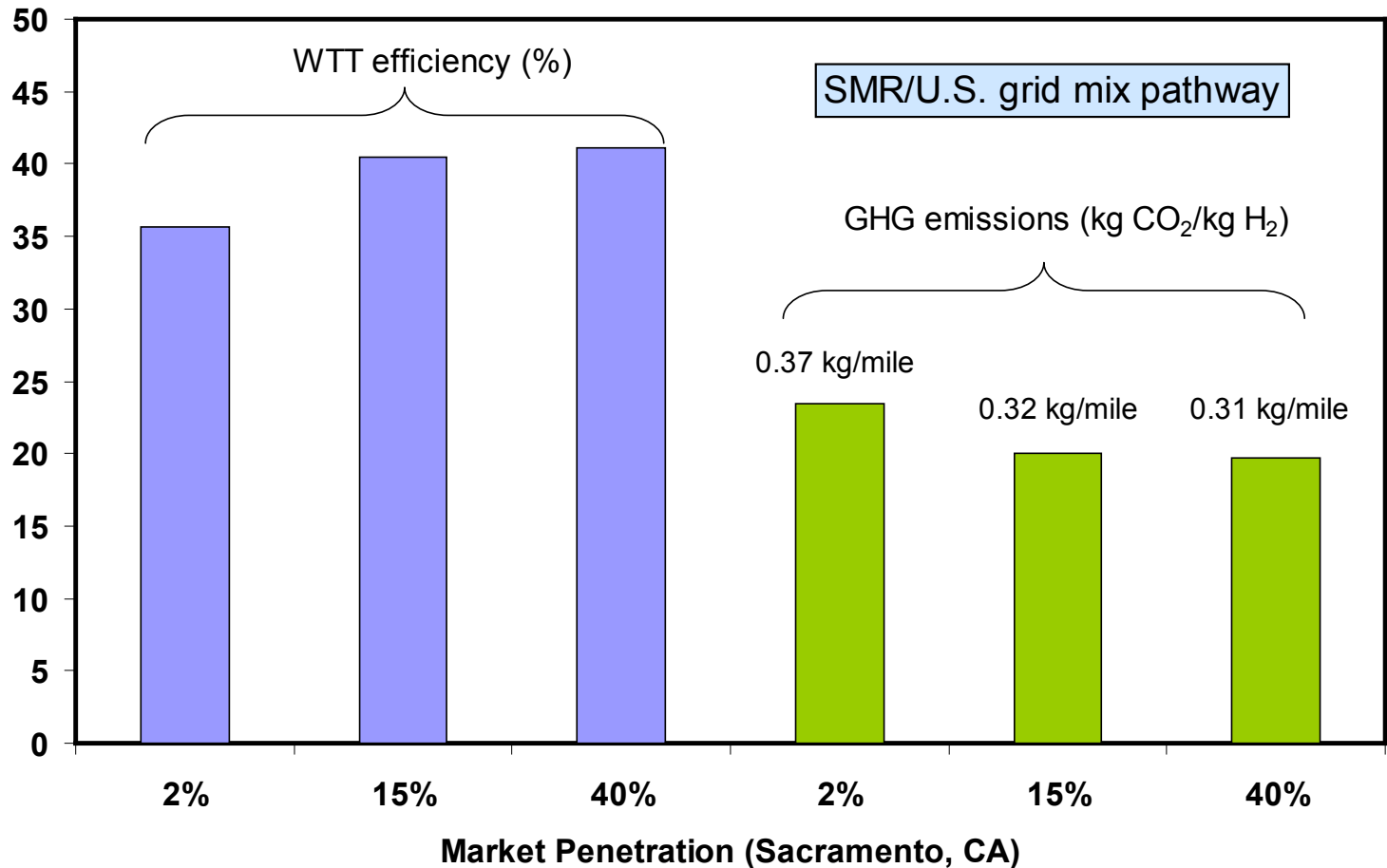

# Refueling Cost

- Fuel cost dominates production cost (SMR: 77% fuel, 14% capital)
- Capital cost dominates delivery cost (55% capital, 18% fuel)
- Delivery cost dominates refueling cost in SMR pathway (67%)

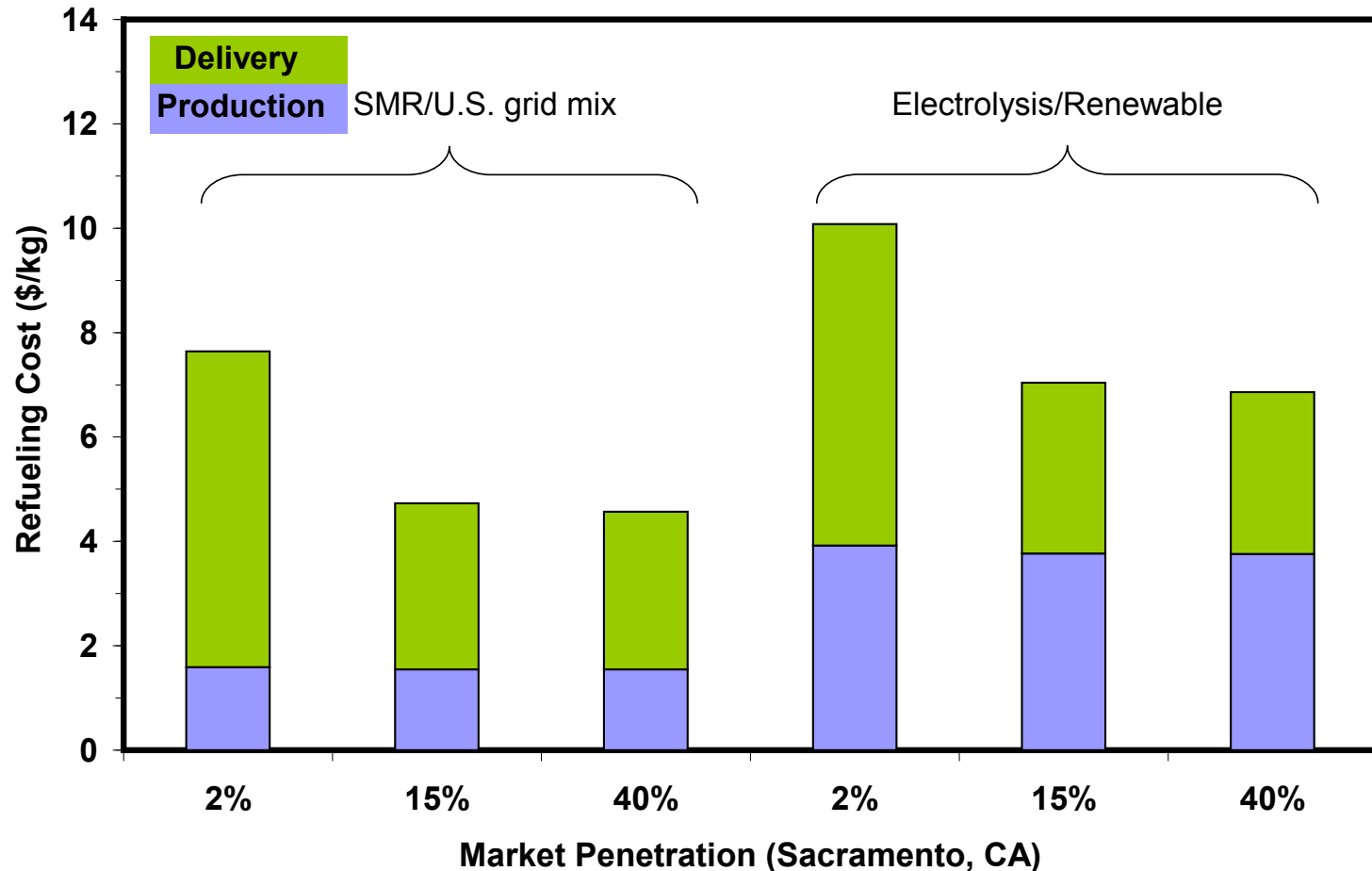

# Ownership Cost

- On-board system accounts for 50% of ownership cost in SMR pathway ( \$18/kWh preliminary TIAX cost estimate)
- Ownership cost >50% higher than for conventional gasoline ICEV (~\$0.1/mile, 30 mpg and \$3/gal untaxed)

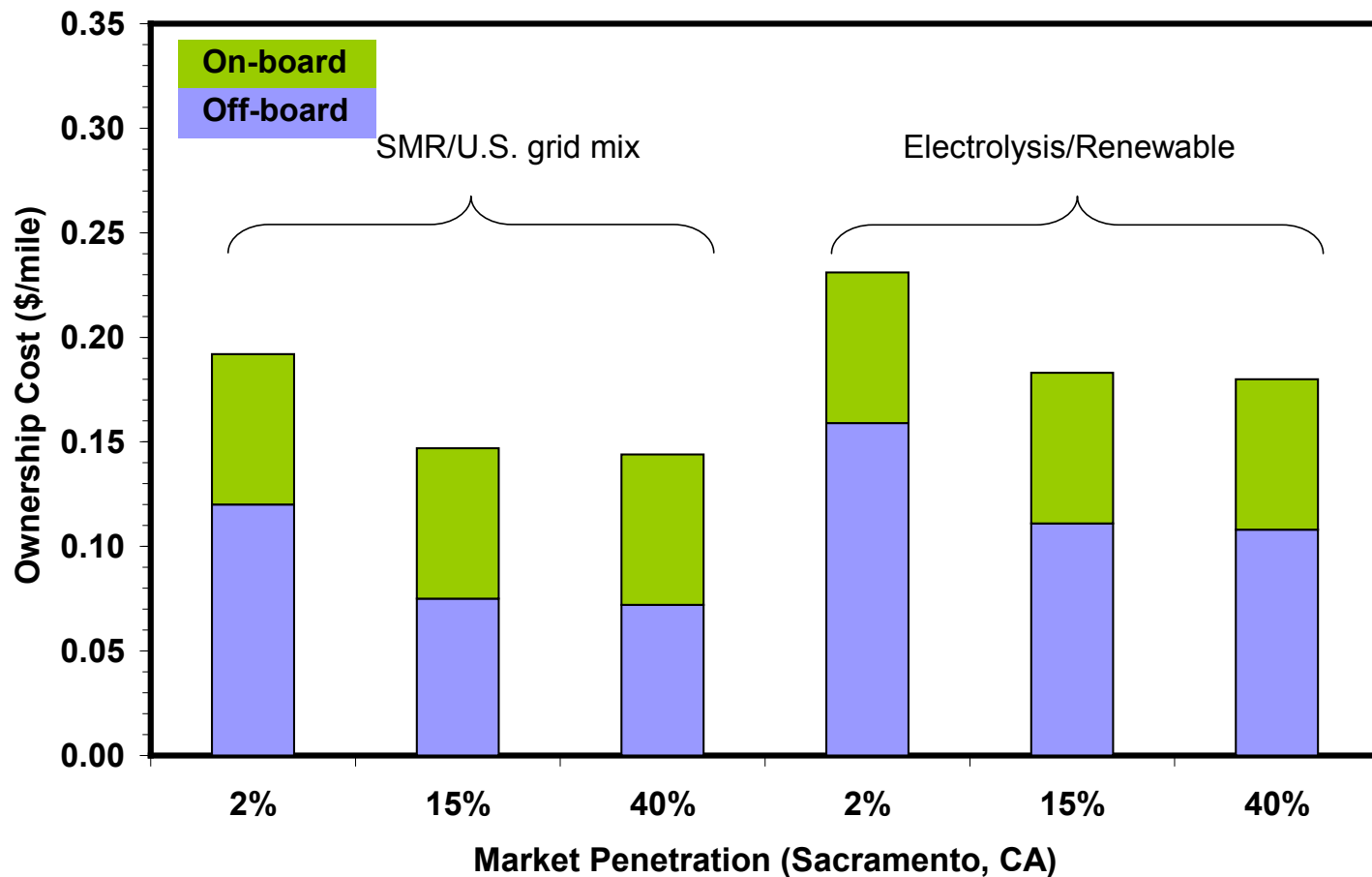

# On-Board and Off-Board Performance of Hydrogen Storage in Metal Organic Frameworks

---

## On-Board Performance

- System with adiabatic liquid H<sub>2</sub> refueling
- Adsorption isotherms
- Gravimetric and volumetric storage capacity
- Refueling and discharge dynamics
- Dormancy and H<sub>2</sub> loss rate
- Sensitivity analyses

## Off-Board Performance

- Regulated pollutant and GHG emissions
- WTT efficiency
- Refueling cost
- Ownership cost



# Hydrogen Storage using Ammonia Borane in Ionic Liquids – Preliminary Results

---

AB/IL on-board storage system

- Physical properties of ionic liquid solvent and AB solution
- Dehydrogenation kinetics
- Dehydrogenation reactor
  - Control of AB conversion and peak temperature
  - Adiabatic operation
- System configuration
- Future work
  - Reactor startup and shutdown
  - Shelf life
  - System gravimetric and volumetric capacities
  - Off-board regeneration and fuel cycle efficiency

# Dehydrogenation Reactor Model

- Main challenge is to control the peak temperature (bmimCL stability, undesirable side products) and AB conversion (regenerability) by using heat transfer and/or product recycle
  - Adiabatic temperature rise in excess of 500°C ( $\Delta T_{ad} = 295N_{H_2}$ )
- AB conversion ( $\Phi$ ,  $\Phi_1$ ,  $\Phi_2$ )
- Recycle ratio ( $R$ )
- Liquid hourly space velocity ( $LHSV$ ) defined on the basis of volumetric flow rate of fuel (AB/IL)

$$\Phi = 1 - \frac{(\beta_1 + \beta_2) \dot{N}_1^p + \beta_2 \dot{N}_2^p}{(\beta_1 + \beta_2) \dot{N}_1^f + \beta_2 \dot{N}_2^f} \quad R = 1 - \frac{(\dot{N}_1^r + \dot{N}_2^r + \dot{N}_3^r + \dot{N}_s^r)}{(\dot{N}_1 + \dot{N}_2 + \dot{N}_3 + \dot{N}_s)} \quad LHSV = \frac{\dot{V}_f}{V_t}$$

$$\Phi_1 = 1 - \frac{\dot{N}_1^{out}}{\dot{N}_1^{in}}$$

$$\Phi_2 = 1 - \frac{\dot{N}_2^{out}}{(\dot{N}_2 + \Phi_1 \dot{N}_1)}$$

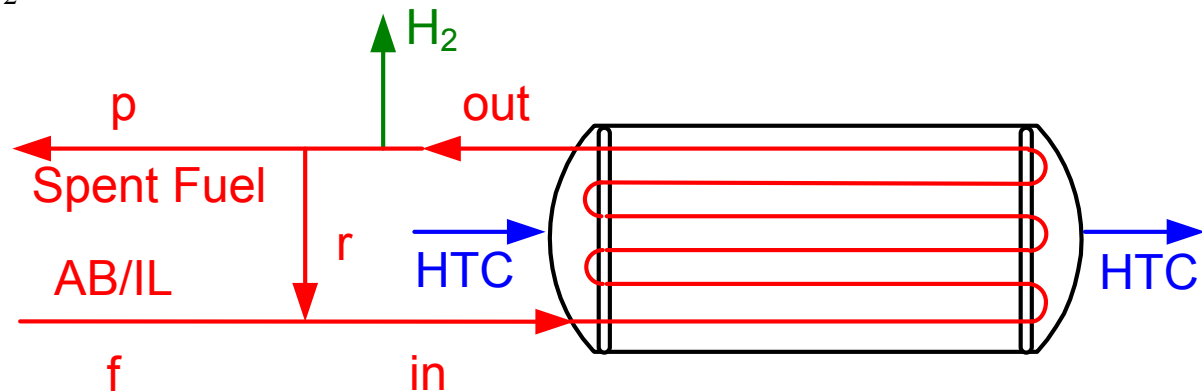



# Dehydrogenation Reactor Performance

- Main challenge: control peak T and AB conversion using heat transfer and product recycle
  - Adiabatic T rise in excess of 500°C ( $\Delta T_{ad} = 295N_{H_2}$ )
- $R < 0.95$  for 100% AB conversion at 150°C inlet T and 150 h<sup>-1</sup> LHSV
- $R > 0.8$  to limit maximum temperature to 250°C

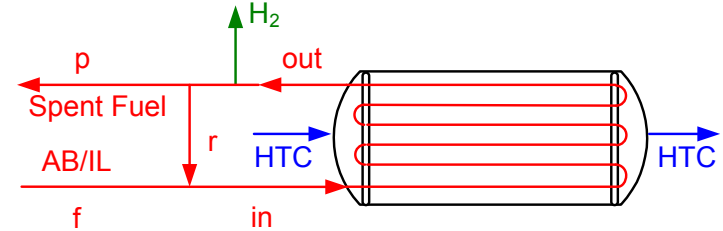
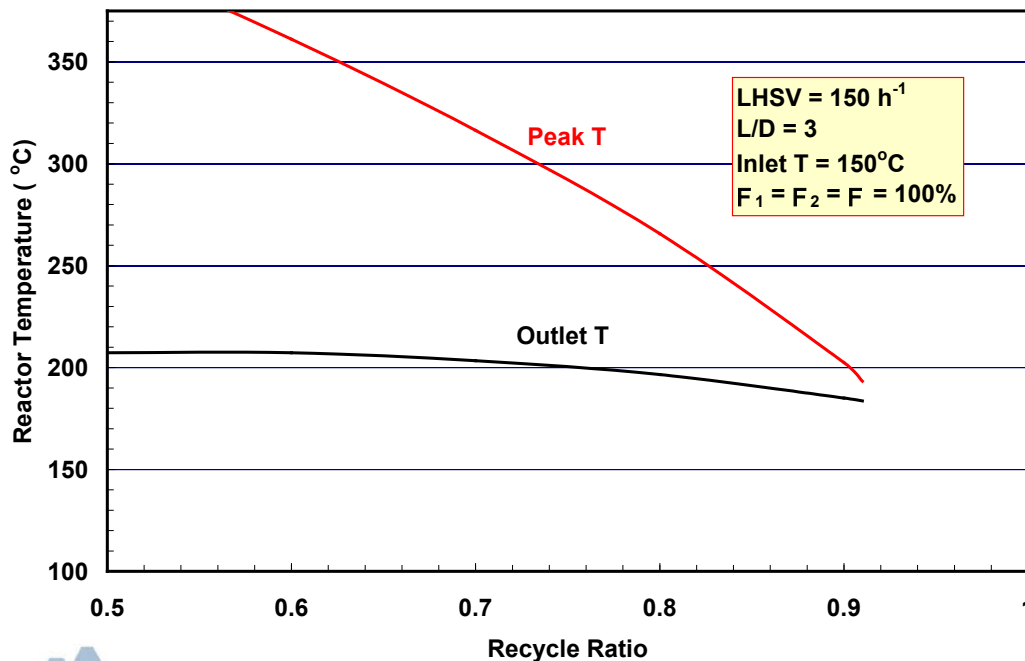

- AB flow rate determined to yield 1.6 g/s of H<sub>2</sub> at 100% conversion
- Coolant (ethylene glycol) flow rate determined to limit  $\Delta T$  to 10°C while absorbing 26.4 kW of heat

# Reactor Temperature and Conversion

- Peak temperature is a function of inlet temperature and R (conversion)
  - $R < 0.55$  for 100% conversion at 125°C inlet T and 150 h<sup>-1</sup> LHSV
  - Peak T > 315°C for  $R < 0.55$
  - For specified conversion, not possible to control the peak temperature by reducing the inlet temperature
  - The coolant removes only a fraction of the heat released
  - Difficult to limit the peak temperature by controlling heat transfer

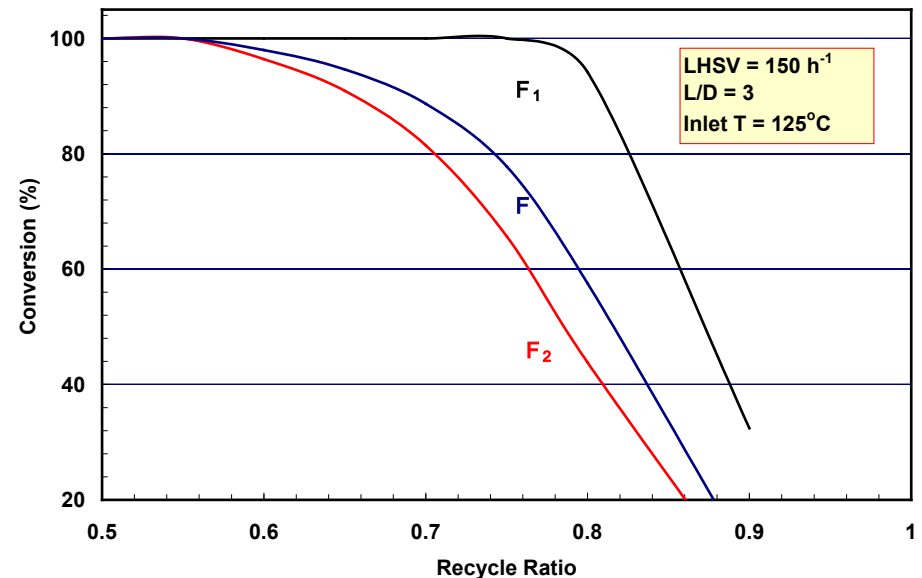
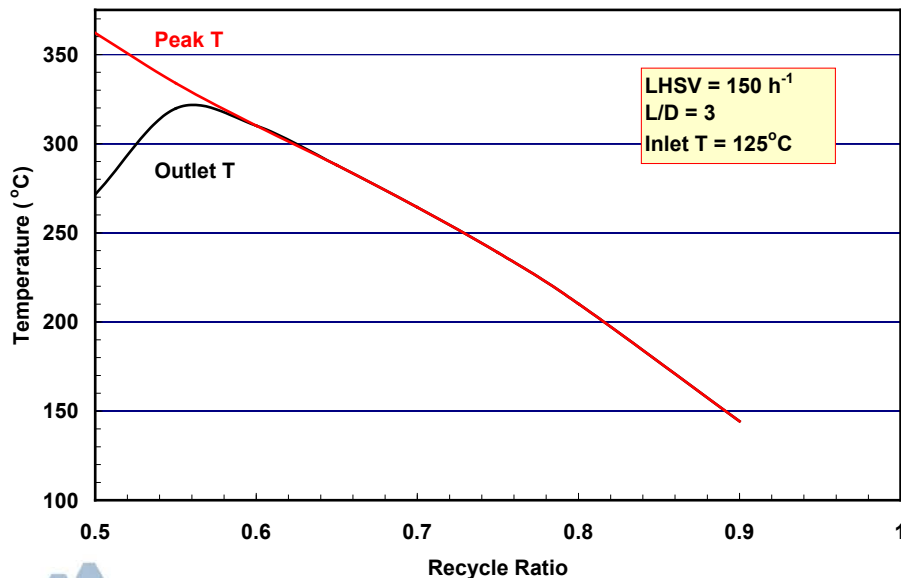

# Reactor Heat Transfer

- Heat transfer depends on the LHSV and R
- Depending on the inlet T and recycle ratio (given LHSV) the coolant removes only a fraction of the heat released by the exothermic reaction (26.4 kW at 100% conversion)
- Difficult to limit the peak temperature by controlling heat transfer

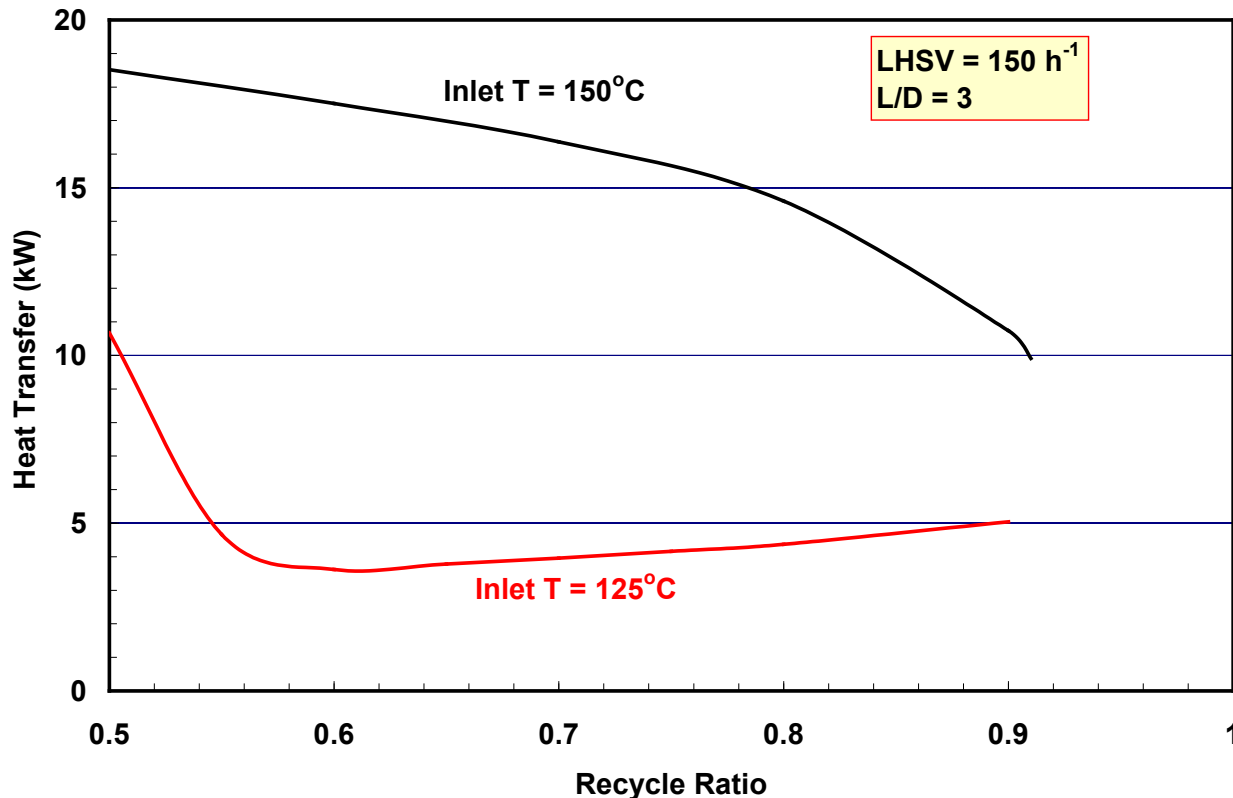

# Summary and Interim Conclusions

---

Product stream recycle needed to control the reactor peak temperature and AB conversion

- Depending on the inlet temperature, R may be  $> 0.9$  to limit the peak temperature to  $< 200^{\circ}\text{C}$ 
  - Very difficult to control the peak temperature with heat transfer
  - Lower inlet temperature does not necessarily lead to lower peak temperature
- The reactor can be operated adiabatically while controlling peak T and AB conversion
  - The reactor peak temperature can be lower if operated adiabatically

Remaining challenges

- Reactor startup and shutdown
- Heat rejection

